

Your Early Childhood Resource



Tables • Chairs • Furniture • More!



## OUR RESPONSIBILITY TO OUR CUSTOMERS

ECR4Kids is committed to developing and distributing the highest quality classroom furniture and equipment; ensuring these products represent the maximum value in today's marketplace. Our focus and commitment continues to be centered on value-added features, functionality and performance while providing optimal service. For the most up to date information on ECR4Kids promotions and announcements, follow us Facebook, Linked In, Pinterest, and Twitter.

- ✓ Family Owned and Operated
- ✓ Quick Ship - Most Orders Process within 2-5 Business Days When in Stock
- ✓ Excellent Customer Service
- ✓ Premier Packaging
- ✓ Everyday Value Manufacturer

## FOLLOW US

-  FACEBOOK
-  LINKED IN
-  PINTEREST
-  TWITTER

## 2 OUR RESPONSIBILITY TO THE ENVIRONMENT

It is our goal to offer the strongest, safest and most sustainable products in the market. ECR4Kids has achieved GREENGUARD [GOLD] Certification for a variety of our products including tables, chairs, furniture, cots, SoftZone®, active play, and more. GREENGUARD Certified products meet or exceed GREENGUARD standards for low chemical emissions into indoor air during product usage. For more information, visit [ul.com/gg](http://ul.com/gg). By choosing ECR4Kids products, you are promoting a safe and healthy environment for you and your children.

 Look for our GREENGUARD [GOLD] Certified products.



## QUICK SHIP

Orders typically process within 2-5 business days when products are in stock. Inventory levels are based on historical sales experience. Changes in current/future sales demands may create limited on-hand quantities while inventories are rebalanced. If a customer is able to provide an item forecast, we can help ensure, although not guarantee, item availability to meet your expectations. Without a forecast, unusual changes in ordering may cause brief delays.

All items ship parcel (UPS/FEDEX) unless notated with a truck symbol. These items must ship LTL. 

## RTA FURNITURE

ECR4Kids is a leader in high quality, ready-to-assemble (RTA) school furniture. Why RTA?

- Low cost alternative to assembled furniture
- Reduced freight cost
- Less freight damage
- Instructions written with teachers in mind
- Pre-assembled kick plates make assembly simpler
- Easy to use tools provided

## SPECIAL PRICING COMBINATION (SPC) AND TABLE AND CHAIR PACKAGES

With SPCs and Table and Chair Packages we take the guess work out by grouping like items and passing along the savings to you and your customers. In addition to the product cost savings, your customers will save on freight by having the packaged items ship from the same destination point. For more SPC and table and chair packages, please contact your Sales Representative.

## ADULT SUPERVISION RECOMMENDED

All items are made with little ones in mind, but as with any product, adult supervision is recommended.

## WWW.ECR4KIDS.COM

Products, images, descriptions, dimensions and more can be found on our website at [www.ecr4kids.com](http://www.ecr4kids.com).

## DEALER PORTAL

For the convenience of our Dealers we have created the ECR4Kids online Dealer Portal. This robust tool allows you to place orders, check inventory, get freight quotes, view your price list, and much more. Available 24/7 at [www.ecr4kids.com/dealerportal](http://www.ecr4kids.com/dealerportal). For your login information, please contact [ecrcs@ecr4kids.com](mailto:ecrcs@ecr4kids.com).

## WATCH PRODUCT VIDEOS ON YOUR SMARTPHONE

Look for the QR Codes to view them instantly.

# CONTENTS

## Tables & Chairs

Adjustable Activity Tables, School Stack Chairs, Bentwood Furniture, Hardwood Tables and Chairs, Resin Tables and Chairs, Open Front Desks

4

## Birch

Coat Lockers, Storage Tray Cabinets, Fold & Lock Tray Cabinets, Bookcases, Dramatic Play Including Kitchens, Bentwood Comfort Furniture, Dress Up Items, Puppet Theater

18

## Colorful Essentials

Storage Cabinets, Book Displays, Dramatic Play Kitchens

28

## Rest Time

Streamline Cots, Stackable Kiddie Cots, Rainbow Rest Mats, Folding Rest Mats, Rest Mat Trolley, and Accessories

32

## Classroom Organization

Mobile Organizers, Universal Rolling Cart, Plastic Storage, Plastic Bins and Trays, Art Caddies, Dry-Erase Board, Collapsible Crate

34

## Blocks

Hardwood Blocks, Architectural Blocks, Tunnels and Arches, Transportation Vehicles, Block Storage and Cart

38

## SoftZone®

360 Degree Climbers, Wall Climbers, Gross Motor Play, Corner Climbers, Functional Development, Sensory Exploration, Seating, Tumbling Mats

40

## Active Play

Caterpillars, Climbers, Houses, Games, and Sand and Water Tables

50

## Art Products

Easels, Carts, Classroom Art Supplies

55

## Infants & Toddlers

Horizontal Changing Station, Baby Changer, and Mirror

57

## Bits & Pieces

Replacement pieces for ECR4Kids products

57

## Product Index

61

## Legend



This item comes with casters



This item ships by truck



This item requires some assembly



This item has achieved GREENGUARD GOLD Certification

# Adjustable Activity Tables

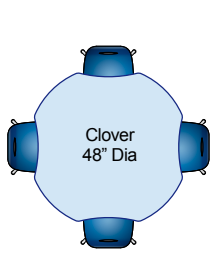

**ELR-14101**

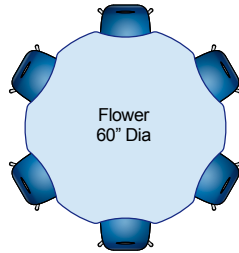

**ELR-14102**

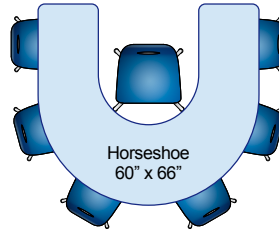

**ELR-14103**

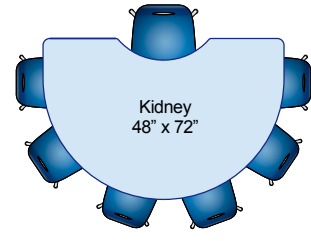

**ELR-14104**

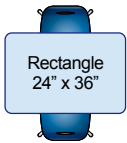

**ELR-14106**

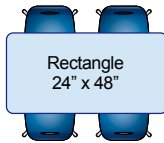

**ELR-14107**

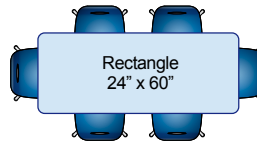

**ELR-14108**

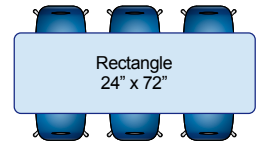

**ELR-14109**

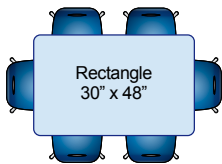

**ELR-14110**

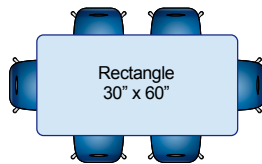

**ELR-14111**

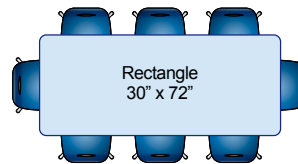

**ELR-14112**

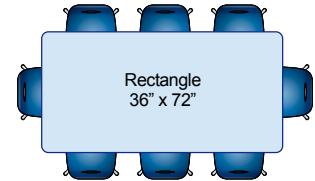

**ELR-14113**

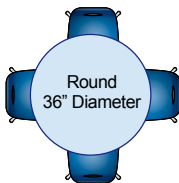

**ELR-14114**

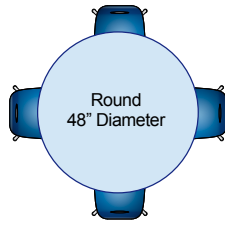

**ELR-14115**

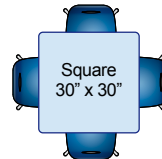

**ELR-14116**

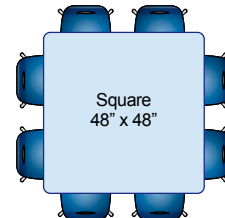

**ELR-14117**



**ELR-14118**



**NEW ELR-14126**

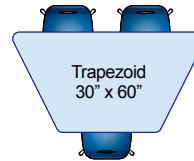

**ELR-14119**

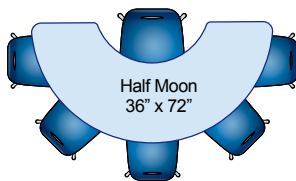

**ELR-14120**

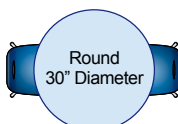

**NEW ELR-14121**

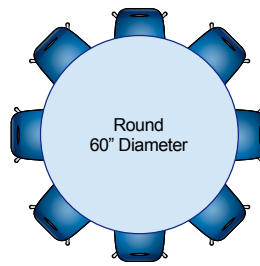

**ELR-14124**



**ELR-14125**

4

*\*Tables above are paired with 12" chairs. Additional configurations will vary based on chair size.*

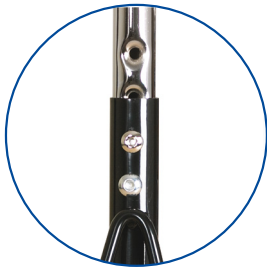

## LEG FEATURES

Adjustable legs feature dual set screws to ensure stable connection  
Lower legs are chrome plated and adjustable in 1" increments  
Upper leg is powder coated tubular steel  
Glide options: Nylon Swivel for hard surface or Ball Glides ideal for carpet



## ADJUSTABLE TABLE HEIGHTS

Standard Legs adjust table height from 19"–30"  
Toddler Legs adjust table height from 15"–23"  
Chunky Legs adjust table height from 15"–24"

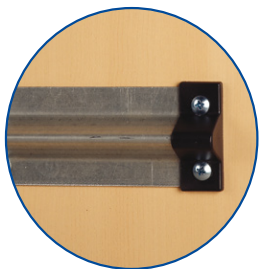

## TABLE FEATURES

Table Top: 1.125" thick  
Easy leg assembly with pre-installed receiving brackets (not available on ELR-14118)  
Steel stability bars pre-installed on Horseshoe, Kidney, Half-Moon, and 72" length tables  
Colorful T-molding matches ECR4Kids School Stack Chairs  
Table Tops feature stain-resistant and easy-to-clean double-sided laminate  
Thermo-fused melamine surface that resists scratches, scuffing, and chemicals

# Adjustable Activity Tables



## 1. CHOOSE YOUR TABLE CONFIGURATION

Must order in case pack quantities of 1

<b>Shape Tables</b>		
<b>ELR-14101-XX</b>	48" Diameter Clover Table	<b>\$230</b>
<b>ELR-14102-XX</b>	60" Diameter Flower Table	<b>\$300</b>
<b>ELR-14103-XX</b>	60" x 66" Horseshoe Table	<b>\$400</b>
<b>ELR-14104-XX</b>	48" x 72" Kidney Table	<b>\$310</b>
<b>ELR-14120-XX</b>	36" x 72" Half Moon Table	<b>\$275</b>
<b>ELR-14125-XX</b>	24" x 48" Half Round Table	<b>\$160</b>
<b>Rectangular Tables</b>		
<b>ELR-14106-XX</b>	24" x 36" Rectangular Table	<b>\$145</b>
<b>ELR-14107-XX</b>	24" x 48" Rectangular Table	<b>\$160</b>
<b>ELR-14108-XX</b>	24" x 60" Rectangular Table	<b>\$200</b>
<b>ELR-14109-XX</b>	24" x 72" Rectangular Table	<b>\$220</b>
<b>ELR-14110-XX</b>	30" x 48" Rectangular Table	<b>\$200</b>
<b>ELR-14111-XX</b>	30" x 60" Rectangular Table	<b>\$220</b>
<b>ELR-14112-XX</b>	30" x 72" Rectangular Table	<b>\$245</b>
<b>ELR-14113-XX</b>	36" x 72" Rectangular Table	<b>\$275</b>

<b>Round Tables</b>		
<b>NEW ELR-14121-XX</b>	30" Diameter Round Table	<b>\$145</b>
<b>ELR-14114-XX</b>	36" Diameter Round Table	<b>\$175</b>
<b>ELR-14115-XX</b>	48" Diameter Round Table	<b>\$230</b>
<b>ELR-14124-XX</b>	60" Diameter Round Table	<b>\$300</b>
<b>Square Tables</b>		
<b>ELR-14116-XX</b>	30" x 30" Square Table	<b>\$145</b>
<b>ELR-14117-XX</b>	48" x 48" Square Table	<b>\$230</b>
<b>Trapezoid Tables</b>		
<b>ELR-14118-XX</b>	18" x 30" Learning Table	<b>\$150</b>
<b>ELR-14119-XX</b>	30" x 60" Trapezoid Table	<b>\$220</b>
<b>NEW ELR-14126-XX</b>	24" x 48" Trapezoid Table	<b>\$145</b>

## 2. CHOOSE YOUR COLOR CONFIGURATION



Choose Leg Color: **MMBL**  
**MMGN**  
**MMNV**  
**MMRD**  
**MMYE**

## 3. CHOOSE YOUR LEG STYLE

- C Chunky
- TB Toddler Leg, Ball Glide
- TS Toddler Leg, Swivel Glide
- SB Standard Leg, Ball Glide
- SS Standard Leg, Swivel Glide



## 4. CHOOSE YOUR GLIDE

**Swivel Glide** - Ideal for hard floors, may not be suited for all carpet types. Glides auto-level to create a level workspace.  
**Ball Glide** - Ideal for carpeted floors, may not be suited for all hard floor surfaces.

For more information visit [www.ecr4kids.com/resources](http://www.ecr4kids.com/resources)

**EXAMPLE**

**Item Number:** ELR-14101-MNV-SS

*Description:* Clover Table 48" Diameter

*Shape Table:* ELR-14101-

*T-Mold + Leg Color:* MNV-

*Leg + Glide Type:* SS



	RECOMMENDED CHAIR SIZES PER AGE					
School Year	Toddler	Preschool	Kindergarten	1st/2nd Grades	3rd/6th Grades	6th Grade +
Age Range	2-4	2-5	3-7	6-9	8-12	12+
Table Height	14"-18"	16"-20"	18"-22"	20"-24"	22"-26"	24"-28"
Chair Height	8"	10"	12"	14"	16"	18"

# School Stack Chair Features



## FEATURES



Molded seat with vented back  
for comfort



Non-tapered steel legs



Steel lower back support and reinforced ribbing in back and under seat  
for added strength



- Nylon swivel glides level chairs independently
- Perfect for hard floors
- Not suited for thick, looped carpeting
- Sleek look for all ages
- Available in all chair sizes

- Composite ball glide for protection on carpeted floors
- Made of polypropylene and nylon for durability
- Not suited for waxed floors, may scuff or mark flooring
- Fun colors for early childhood environments
- Available in 10" - 16" Chairs



- Snap on felt protector for use with swivel glides
- Prevents scratching and other floor damage
- Adds new life to old glides
- Reduces sound and noise for a better learning environment
- ELR-15102 felt glides sold separately



## SCHOOL STACK CHAIRS

Specify Color and Glide

Chrome and matching legs available with ball or swivel glides. For nylon swivel glides please add "G" to the item number.

Example: ELR-0192-BLG = 10" Blue Stack Chair with Nylon Swivel Glide

Must order in case pack quantities of:

10" = 6, 12" = 6, 14" = 6, 16" = 6, 18" = 5

### Chrome Legs

Colors: Blue (BL), Green (GN), Red (RD), Yellow (YE), Hunter Green (HG), Navy (NV), Burgundy (BY), Purple (PU), Sand (SD)

<b>ELR-0192-XX</b>	10" Stack Chair - Chrome Legs	Shell: 10.6"W x 12"D x 9.1"H; Seat Height: 10"	<b>\$40</b>
<b>ELR-0193-XX</b>	12" Stack Chair - Chrome Legs	Shell: 13.1"W x 13.1"D x 12.4"H; Seat Height: 12"	<b>\$43</b>
<b>ELR-0194-XX</b>	14" Stack Chair - Chrome Legs	Shell: 13.1"W x 13.1"D x 12.4"H; Seat Height: 14"	<b>\$45</b>
<b>ELR-0195-XX</b>	16" Stack Chair - Chrome Legs	Shell: 13.1"W x 13.1"D x 12.4"H; Seat Height: 16"	<b>\$55</b>

18" Stack Chairs are available with chrome legs and swivel glides in the following colors: Blue (BL), Green (GN), Red (RD), Yellow (YE), Hunter Green (HG), Navy (NV), Burgundy (BY), Sand (SD), Black (BK), Grey (GY)

<b>ELR-15104-XX</b>	18" Stack Chair - Chrome Legs	Shell: 15.5"W x 15.5"D x 15"H; Seat Height: 18"	<b>\$65</b>
---------------------	-------------------------------	---	-------------

### Matching Powder Coated Legs

Colors: Blue (BL), Green (GN), Red (RD), Yellow (YE)

<b>ELR-2192-XX</b>	10" Stack Chair - Matching Legs	Shell: 10.6"W x 12"D x 9.1"H; Seat Height: 10"	<b>\$38</b>
<b>ELR-2193-XX</b>	12" Stack Chair - Matching Legs	Shell: 13.1"W x 13.1"D x 12.4"H; Seat Height: 12"	<b>\$42</b>
<b>ELR-2194-XX</b>	14" Stack Chair - Matching Legs	Shell: 13.1"W x 13.1"D x 12.4"H; Seat Height: 14"	<b>\$45</b>
<b>ELR-2195-XX</b>	16" Stack Chair - Matching Legs	Shell: 13.1"W x 13.1"D x 12.4"H; Seat Height: 16"	<b>\$52</b>

### Assorted Packs

Chrome and matching legs available with ball or swivel glides. For nylon swivel glides please add "G" to the item number.

<b>ELR-15141-AS</b>	10" Stack Chair - Chrome Legs	2 Blue, 2 Red, 1 Yellow, 1 Green	<b>\$240</b>
<b>ELR-15110-AS</b>	12" Stack Chair - Chrome Legs	2 Blue, 2 Red, 1 Yellow, 1 Green	<b>\$258</b>
<b>ELR-15111-AS</b>	14" Stack Chair - Chrome Legs	2 Blue, 2 Red, 1 Yellow, 1 Green	<b>\$270</b>
<b>ELR-15112-AS</b>	16" Stack Chair - Chrome Legs	2 Blue, 2 Red, 1 Yellow, 1 Green	<b>\$330</b>
<b>ELR-15140-AS</b>	10" Stack Chair - Matching Legs	2 Blue, 2 Red, 1 Yellow, 1 Green	<b>\$228</b>
<b>ELR-15107-AS</b>	12" Stack Chair - Matching Legs	2 Blue, 2 Red, 1 Yellow, 1 Green	<b>\$252</b>
<b>ELR-15108-AS</b>	14" Stack Chair - Matching Legs	2 Blue, 2 Red, 1 Yellow, 1 Green	<b>\$270</b>
<b>ELR-15120-AS</b>	16" Stack Chair - Matching Legs	2 Blue, 2 Red, 1 Yellow, 1 Green	<b>\$312</b>

Accessories		
	<b>ELR-15102</b> Snap on Felt Glides - 96 ct For use on hard surfaces.	<b>\$30</b>
		

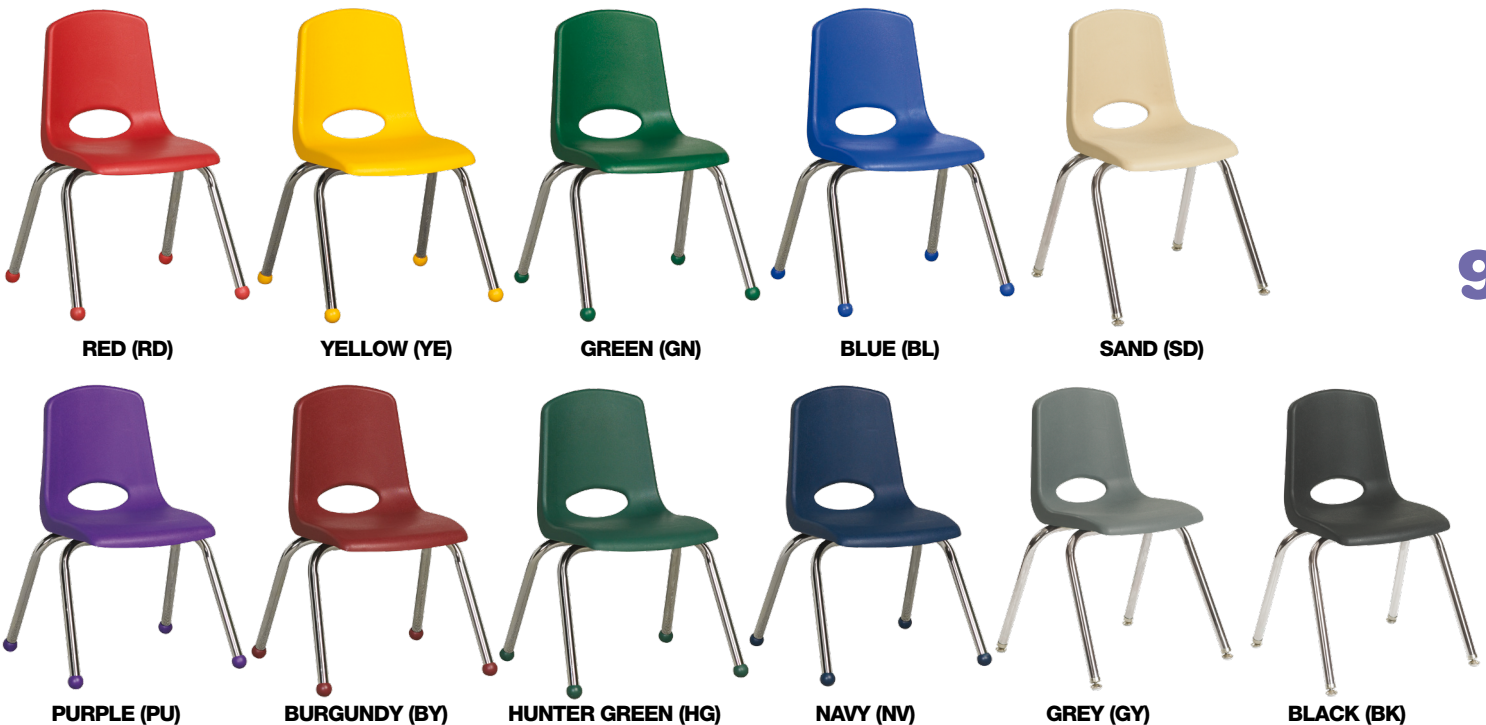

# Table and Chair Packages



## TABLE AND CHAIR PACKAGES

Specify Color and Glide

With ECR4Kids **NEW** Table and Chair Packages, we remove the guess work by grouping the correct size, coordinating color, and appropriate quantity of chairs per table. The perfect solution for your classroom, day-care, home, or office!

- Correct quantity of chairs per table based on chair size. Doesn't matter what the case pack is; no extra chairs!
- 5% savings by purchasing the table and chair as a package vs. individuals items.
- Potential for reduced freight costs as all items will ship from the same location.

### 1. CHOOSE YOUR TABLE CONFIGURATION

#### Shape Tables

- ELR-14101-XX** 48" Diameter Clover Table
- ELR-14102-XX** 60" Diameter Flower Table
- ELR-14103-XX** 60" x 66" Horseshoe Table
- ELR-14104-XX** 48" x 72" Kidney Table
- ELR-14120-XX** 36" x 72" Half Moon Table

#### Round Tables

- ELR-14114-XX** 36" Diameter Round Table
- ELR-14115-XX** 48" Diameter Round Table
- ELR-14124-XX** 60" Diameter Round Table

#### Rectangular Tables

- ELR-14107-XX** 24" x 48" Rectangular Table
- ELR-14108-XX** 24" x 60" Rectangular Table
- ELR-14109-XX** 24" x 72" Rectangular Table
- ELR-14110-XX** 30" x 48" Rectangular Table
- ELR-14111-XX** 30" x 60" Rectangular Table
- ELR-14112-XX** 30" x 72" Rectangular Table
- ELR-14113-XX** 36" x 72" Rectangular Table

#### Square Tables

- ELR-14116-XX** 30" x 30" Square Table
- ELR-14117-XX** 48" x 48" Square Table

### 2. SELECT YOUR DESIRED TABLE COLOR COMBINATION



### 3. PICK TABLE LEG STYLE TO FIT CHAIR SIZE

		Chair Sizes					
		10"	12"	14"	16"	18"	
Table Leg Style	C	Chunky	x	x	x		
	TB	Toddler Ball	x	x			
	TS	Toddler Swivel	x	x			
	SB	Standard Ball			x	x	
	SS	Standard Swivel			x	x	x



### CHAIR COLOR MATCHES TABLE COLOR EDGE BANDING COMBINATION

Table Color	Chair Color
Grey/Blue (GBL)	Blue (BL)
Grey/Green (GGN)	Green (GN)
Grey/Navy (GNV)	Navy (NV)
Grey/Red (GRD)	Red (RD)
Grey/Yellow (GYE)	Yellow (YE)
Maple/Black (MBBK)	Navy (NV)
Oak/Black (OKBK)	Navy (NV)

Actual colors may vary.

### TABLE LEG STYLE MATCHES CHAIR GLIDE

Chunky, Toddler Ball, Standard Ball Table Legs = School Stack Chairs with Ball Glides

Toddler Swivel and Standard Swivel Table Legs = School Stack Chairs with Swivel Glides

Item Number: **ELR14101P4X14-MBBKSS**

Table Configuration: **ELR-14101**

Chair Quantity and Size: **P4X14-**

Table Color, T-Mold, Leg Color : **MBBK**

Table Leg + Glide Type: **SS**

Chair Color: Navy



## Shape Tables

<b>ELR14101P4X10-XX</b>	48" Clover Table, 4 X 10" Chairs	<b>\$390</b>
<b>ELR14101P4X12-XX</b>	48" Clover Table, 4 X 12" Chairs	<b>\$402</b>
<b>ELR14101P4X14-XX</b>	48" Clover Table, 4 X 14" Chairs	<b>\$410</b>
<b>ELR14101P4X16-XX</b>	48" Clover Table, 4 X 16" Chairs	<b>\$450</b>
<b>ELR14101P4X18-XX</b>	48" Clover Table, 4 X 18" Chairs	<b>\$490</b>

<b>ELR14102P6X10-XX</b>	60" Flower Table, 6 X 10" Chairs	<b>\$540</b>
<b>ELR14102P6X12-XX</b>	60" Flower Table, 6 X 12" Chairs	<b>\$558</b>
<b>ELR14102P6X14-XX</b>	60" Flower Table, 6 X 14" Chairs	<b>\$570</b>
<b>ELR14102P6X16-XX</b>	60" Flower Table, 6 X 16" Chairs	<b>\$630</b>
<b>ELR14102P6X18-XX</b>	60" Flower Table, 6 X 18" Chairs	<b>\$690</b>

<b>ELR14103P9X10-XX</b>	60" x 66" Horseshoe Table, 9 X 10" Chairs	<b>\$760</b>
<b>ELR14103P7X12-XX</b>	60" x 66" Horseshoe Table, 7 X 12" Chairs	<b>\$701</b>
<b>ELR14103P7X14-XX</b>	60" x 66" Horseshoe Table, 7 X 14" Chairs	<b>\$715</b>
<b>ELR14103P7X16-XX</b>	60" x 66" Horseshoe Table, 7 X 16" Chairs	<b>\$785</b>
<b>ELR14103P7X18-XX</b>	60" x 66" Horseshoe Table, 7 X 18" Chairs	<b>\$855</b>

<b>ELR14104P8X10-XX</b>	48" x 72" Kidney Table, 8 X 10" Chairs	<b>\$630</b>
<b>ELR14104P7X12-XX</b>	48" x 72" Kidney Table, 7 X 12" Chairs	<b>\$611</b>
<b>ELR14104P6X14-XX</b>	48" x 72" Kidney Table, 6 X 14" Chairs	<b>\$580</b>
<b>ELR14104P6X16-XX</b>	48" x 72" Kidney Table, 6 X 16" Chairs	<b>\$640</b>
<b>ELR14104P5X18-XX</b>	48" x 72" Kidney Table, 5 X 18" Chairs	<b>\$635</b>

<b>ELR14120P6X10-XX</b>	36" x 72" Half Moon Table, 6 X 10" Chairs	<b>\$515</b>
<b>ELR14120P6X12-XX</b>	36" x 72" Half Moon Table, 6 X 12" Chairs	<b>\$533</b>
<b>ELR14120P6X14-XX</b>	36" x 72" Half Moon Table, 6 X 14" Chairs	<b>\$545</b>
<b>ELR14120P6X16-XX</b>	36" x 72" Half Moon Table, 6 X 16" Chairs	<b>\$605</b>
<b>ELR14120P4X18-XX</b>	36" x 72" Half Moon Table, 4 X 18" Chairs	<b>\$535</b>

## Round Tables

<b>ELR14114P4X10-XX</b>	36" Round Table, 4 X 10" Chairs	<b>\$335</b>
<b>ELR14114P4X12-XX</b>	36" Round Table, 4 X 12" Chairs	<b>\$347</b>
<b>ELR14114P4X14-XX</b>	36" Round Table, 4 X 14" Chairs	<b>\$355</b>
<b>ELR14114P4X16-XX</b>	36" Round Table, 4 X 16" Chairs	<b>\$385</b>
<b>ELR14114P4X18-XX</b>	36" Round Table, 4 X 18" Chairs	<b>\$435</b>

<b>ELR14115P8X10-XX</b>	48" Round Table, 8 X 10" Chairs	<b>\$550</b>
<b>ELR14115P4X12-XX</b>	48" Round Table, 4 X 12" Chairs	<b>\$402</b>
<b>ELR14115P4X14-XX</b>	48" Round Table, 4 X 14" Chairs	<b>\$410</b>
<b>ELR14115P4X16-XX</b>	48" Round Table, 4 X 16" Chairs	<b>\$450</b>
<b>ELR14115P4X18-XX</b>	48" Round Table, 4 X 18" Chairs	<b>\$490</b>

<b>ELR14124P8X10-XX</b>	60" Round Table, 8 X 10" Chairs	<b>\$620</b>
<b>ELR14124P8X12-XX</b>	60" Round Table, 8 X 12" Chairs	<b>\$644</b>
<b>ELR14124P8X14-XX</b>	60" Round Table, 8 X 14" Chairs	<b>\$660</b>
<b>ELR14124P8X16-XX</b>	60" Round Table, 8 X 16" Chairs	<b>\$740</b>
<b>ELR14124P8X18-XX</b>	60" Round Table, 8 X 18" Chairs	<b>\$820</b>

## Square Tables

<b>ELR14116P4X10-XX</b>	30" Square Table, 4 X 10" Chairs	<b>\$305</b>
<b>ELR14116P4X12-XX</b>	30" Square Table, 4 X 12" Chairs	<b>\$317</b>
<b>ELR14116P4X14-XX</b>	30" Square Table, 4 X 14" Chairs	<b>\$325</b>
<b>ELR14116P4X16-XX</b>	30" Square Table, 4 X 16" Chairs	<b>\$365</b>
<b>ELR14116P4X18-XX</b>	30" Square Table, 4 X 18" Chairs	<b>\$405</b>

## Rectangular Tables

<b>ELR14107P6X10-XX</b>	24" x 48" Rectangular Table, 6 X 10" Chairs	<b>\$400</b>
<b>ELR14107P4X12-XX</b>	24" x 48" Rectangular Table, 4 X 12" Chairs	<b>\$332</b>
<b>ELR14107P4X14-XX</b>	24" x 48" Rectangular Table, 4 X 14" Chairs	<b>\$340</b>
<b>ELR14107P4X16-XX</b>	24" x 48" Rectangular Table, 4 X 16" Chairs	<b>\$380</b>
<b>ELR14107P4X18-XX</b>	24" x 48" Rectangular Table, 4 X 18" Chairs	<b>\$420</b>

<b>ELR14108P6X10-XX</b>	24" x 60" Rectangular Table, 6 X 10" Chairs	<b>\$440</b>
<b>ELR14108P6X12-XX</b>	24" x 60" Rectangular Table, 6 X 12" Chairs	<b>\$458</b>
<b>ELR14108P6X14-XX</b>	24" x 60" Rectangular Table, 6 X 14" Chairs	<b>\$470</b>
<b>ELR14108P4X16-XX</b>	24" x 60" Rectangular Table, 4 X 16" Chairs	<b>\$420</b>
<b>ELR14108P4X18-XX</b>	24" x 60" Rectangular Table, 4 X 18" Chairs	<b>\$460</b>

<b>ELR14109P8X10-XX</b>	24" x 72" Rectangular Table, 8 X 10" Chairs	<b>\$540</b>
<b>ELR14109P6X12-XX</b>	24" x 72" Rectangular Table, 6 X 12" Chairs	<b>\$478</b>
<b>ELR14109P6X14-XX</b>	24" x 72" Rectangular Table, 6 X 14" Chairs	<b>\$490</b>
<b>ELR14109P6X16-XX</b>	24" x 72" Rectangular Table, 6 X 16" Chairs	<b>\$550</b>
<b>ELR14109P6X18-XX</b>	24" x 72" Rectangular Table, 6 X 18" Chairs	<b>\$610</b>

<b>ELR14110P6X10-XX</b>	30" x 48" Rectangular Table, 6 X 10" Chairs	<b>\$440</b>
<b>ELR14110P6X12-XX</b>	30" x 48" Rectangular Table, 6 X 12" Chairs	<b>\$458</b>
<b>ELR14110P4X14-XX</b>	30" x 48" Rectangular Table, 4 X 14" Chairs	<b>\$380</b>
<b>ELR14110P4X16-XX</b>	30" x 48" Rectangular Table, 4 X 16" Chairs	<b>\$420</b>
<b>ELR14110P4X18-XX</b>	30" x 48" Rectangular Table, 4 X 18" Chairs	<b>\$460</b>

<b>ELR14111P8X10-XX</b>	30" x 60" Rectangular Table, 8 X 10" Chairs	<b>\$540</b>
<b>ELR14111P6X12-XX</b>	30" x 60" Rectangular Table, 6 X 12" Chairs	<b>\$478</b>
<b>ELR14111P6X14-XX</b>	30" x 60" Rectangular Table, 6 X 14" Chairs	<b>\$490</b>
<b>ELR14111P6X16-XX</b>	30" x 60" Rectangular Table, 6 X 16" Chairs	<b>\$550</b>
<b>ELR14111P4X18-XX</b>	30" x 60" Rectangular Table, 4 X 18" Chairs	<b>\$480</b>

<b>ELR14112P8X10-XX</b>	30" x 72" Rectangular Table, 8 X 10" Chairs	<b>\$565</b>
<b>ELR14112P8X12-XX</b>	30" x 72" Rectangular Table, 8 X 12" Chairs	<b>\$589</b>
<b>ELR14112P8X14-XX</b>	30" x 72" Rectangular Table, 8 X 14" Chairs	<b>\$605</b>
<b>ELR14112P8X16-XX</b>	30" x 72" Rectangular Table, 8 X 16" Chairs	<b>\$685</b>
<b>ELR14112P6X18-XX</b>	30" x 72" Rectangular Table, 6 X 18" Chairs	<b>\$635</b>

<b>ELR14113P8X10-XX</b>	36" x 72" Rectangular Table, 9 X 10" Chairs	<b>\$595</b>
<b>ELR14113P8X12-XX</b>	36" x 72" Rectangular Table, 8 X 12" Chairs	<b>\$619</b>
<b>ELR14113P8X14-XX</b>	36" x 72" Rectangular Table, 8 X 14" Chairs	<b>\$635</b>
<b>ELR14113P8X16-XX</b>	36" x 72" Rectangular Table, 8 X 16" Chairs	<b>\$715</b>
<b>ELR14113P8X18-XX</b>	36" x 72" Rectangular Table, 8 X 18" Chairs	<b>\$795</b>

<b>ELR14117P8X10-XX</b>	48" Square Table, 8 X 10" Chairs	<b>\$550</b>
<b>ELR14117P8X12-XX</b>	48" Square Table, 8 X 12" Chairs	<b>\$574</b>
<b>ELR14117P8X14-XX</b>	48" Square Table, 8 X 14" Chairs	<b>\$590</b>
<b>ELR14117P8X16-XX</b>	48" Square Table, 8 X 16" Chairs	<b>\$670</b>
<b>ELR14117P8X18-XX</b>	48" Square Table, 8 X 18" Chairs	<b>\$750</b>



## BENTWOOD CHAIRS

Perfect for class time or play time, ECR4Kids Bentwood Chairs marry form with function. These comfortable, lightweight chairs are easy for little ones to pick up on their own, so you can move quickly from musical chairs to math lessons. And when it's time for the hokey-pokey, Bentwood Chairs stack away easily to save space when not in use. Chairs of the same size stack four high. Made of multi-ply birch, chairs feature a uni-body design contoured for healthy posture, smooth rounded edges, and non-scuff boots to reduce noise and protect flooring. Beautifully designed, Bentwood Chairs feature a natural wood finish and require proper care.

Clean and care: check for loose or worn parts periodically and tighten or replace as necessary. Use a clean, damp cloth or sponge with mild soap, non-bleach detergent, or general purpose cleanser. Abrasive cleaners or powders should not be used as they may permanently dull or scratch the surface. Wipe dry thoroughly.

Must order in case pack quantities of 2.

<b>ELR-0644-NT</b>	10" Bentwood Chair Natural	<b>\$85</b>
<b>ELR-0645-NT</b>	12" Bentwood Chair Natural	<b>\$90</b>
<b>ELR-0646-NT</b>	14" Bentwood Chair Natural	<b>\$100</b>
<b>ELR-0647-NT</b>	16" Bentwood Chair Natural	<b>\$120</b>
<b>ELR-0660-NT</b>	12" Teacher Bentwood Chair Natural	<b>\$110</b>

Accessories		
	<b>Remove chairs from use if rubber boots become loose or fall off.</b>	
<b>ELR-23102-XX</b>	20 Pc Replacement Boots - Large Case pack of 4; for use on 16" and 12" Teacher chairs.	<b>\$20</b>
<b>ELR-23103-XX</b>	20 Pc Replacement Boots - Small Case pack of 4; for use on 10", 12", and 14" chairs.	<b>\$20</b>

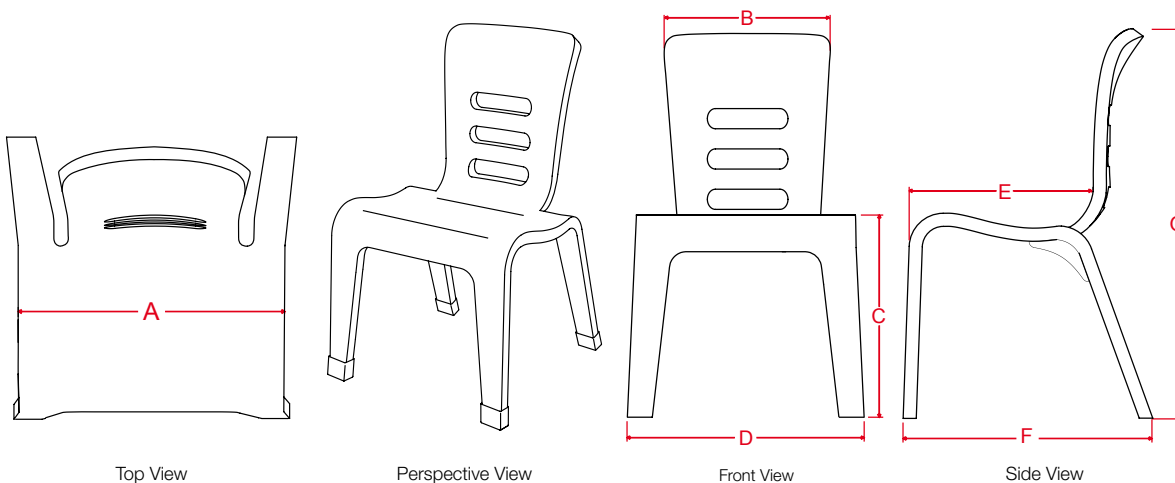

Measurement	C-0644-NT-B 10" Chair		C-0645-NT-B 12" Chair		C-0646-NT-B 14" Chair		C-0647-NT-B 16" Chair		C-0648-NT-B 18" Chair		C-0660-NT-B 12" Teacher Chair	
	Inch	mm	Inch	mm	Inch	mm	Inch	mm	Inch	mm	Inch	mm
<b>A</b> Seat Width	11.4	289	13.1	333	14.0	355	15.2	387	16.3	415	15.3	389
<b>B</b> Upper Back Width	8.2	209	9.4	238	10.2	258	11.3	287	12.5	318	11.7	298
<b>C</b> Seat Height	10.0	254	11.8	300	14.0	356	16.1	410	17.3	440	12.0	305
<b>D</b> Overall Width	11.8	299	13.5	343	15.4	390	19.6	498	17.5	445	16.5	419
<b>E</b> Seat Depth	9.0	229	10.7	271	12.5	318	14.1	358	15.7	400	13.7	349
<b>F</b> Overall Depth	11.8	301	15.0	381	16.3	415	17.4	442	19.9	505	16.8	427
<b>G</b> Overall Height	18.9	480	22.2	565	25.6	650	28.6	727	32.2	819	25.4	645

## BENTWOOD PLAY TABLES

Bentwood Play Tables invite little ones to pull up a chair and play! Perfect for playing games and doing puzzles, tables have plenty of space for friends to share and work together. The easy-to-clean natural finish and a 1 cm recessed surface keeps games and objects from rolling to the floor. Multi-ply birch tables feature rounded edges for safety, and sturdy legs with non-scuffing boots to reduce noise and protect flooring. Bentwood Play Tables are designed to complement the Bentwood Chairs. Easy to assemble. 

Clean and care: check for loose or worn parts periodically and tighten or replace as necessary. Use a clean, damp cloth or sponge with mild soap, non-bleach detergent, or general purpose cleanser. Abrasive cleaners or powders should not be used as they may permanently dull or scratch the surface. Wipe dry thoroughly.

Must order in case pack quantities of 1.

### Round Table Top

30" Diameter Table Top

<b>ELR-14301-16</b>	Natural Birch	16" Legs	<b>\$130</b>
<b>ELR-14301-18</b>	Natural Birch	18" Legs	<b>\$130</b>
<b>ELR-14301-20</b>	Natural Birch	20" Legs	<b>\$130</b>

### Square Table Top

30" x 30" Table Top

<b>ELR-14302-16</b>	Natural Birch	16" Legs	<b>\$130</b>
<b>ELR-14302-18</b>	Natural Birch	18" Legs	<b>\$130</b>
<b>ELR-14302-20</b>	Natural Birch	20" Legs	<b>\$130</b>

### Rectangle Table Top

30" x 48" Table Top

<b>ELR-14303-16</b>	Natural Birch	16" Legs	<b>\$180</b>
<b>ELR-14303-18</b>	Natural Birch	18" Legs	<b>\$180</b>
<b>ELR-14303-20</b>	Natural Birch	20" Legs	<b>\$180</b>



ELR-14303-18

Tables & Chairs

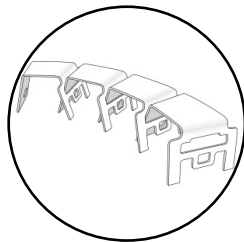

Curved formation or circle

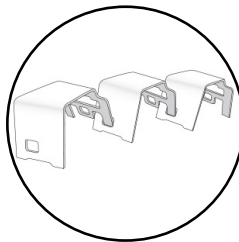

Staggered configuration

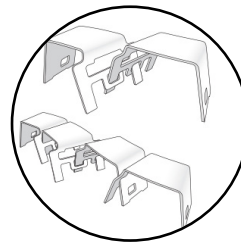

Opposite pattern

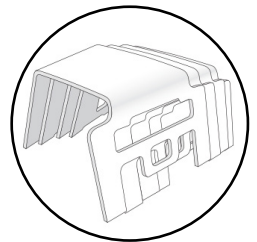

Stack four high



10' Perfect Circle  
with 20 Bentwood Linking Stools!

## BENTWOOD LINKING STOOLS

Little ones will love helping you make a learning circle with the Bentwood Linking Stools from ECR4Kids. Safe and easy to link together and pull apart, stools transform quickly from single seats to benches to amphitheater-style rows when it's time for show-and-tell. 20 stools link together to form a perfect circle with plenty of room for everyone—multiple configurations provide endless classroom possibilities! Comfortable stools feature a uni-body design made of multi-ply birch, with smooth rounded edges. Designed as a complement to the Bentwood collection, stools stack four high to save space.

Must order in case pack quantities of 4.

<b>ELR-15326</b>	Bentwood Linking Stools	22"W x 17"D 12"H	<b>\$85</b>
------------------	-------------------------	------------------	-------------

# Hardwood Tables and Chairs

## HARDWOOD TABLES

Everyone will want to sit at the kids' table! Deluxe solid Hardwood Tables are perfect for art projects, games, or decadent lunchtime feasts. The table top features an attractive natural finish that is easy-to-clean. Available in multiple heights and sizes, tables are versatile and convenient for use in school or at home. Hardwood tables feature a 0.75" bull-nose edge and sturdy 1.75" square legs. 

*Must order in case pack quantities of 1*

<b>ELR-060</b>	30" Round Wood Table with 18" Legs	<b>\$150</b>
<b>ELR-061</b>	30" Round Wood Table with 22" Legs	<b>\$150</b>
<b>ELR-063</b>	24" x 36" Wood Table with 18" Legs	<b>\$140</b>
<b>ELR-064</b>	24" x 36" Wood Table with 22" Legs	<b>\$140</b>
<b>ELR-065</b>	24" x 48" Wood Table with 18" Legs	<b>\$170</b>
<b>ELR-066</b>	24" x 48" Wood Table with 22" Legs	<b>\$170</b>
<b>ELR-067</b>	30" x 48" Wood Table with 18" Legs	<b>\$200</b>
<b>ELR-068</b>	30" x 48" Wood Table with 22" Legs	<b>\$200</b>
<b>ELR-069</b>	24" Square Wood Table with 18" Legs	<b>\$120</b>
<b>ELR-070</b>	24" Square Wood Table with 22" Legs	<b>\$120</b>
<b>ELR-071</b>	30" Square Wood Table with 18" Legs	<b>\$150</b>
<b>ELR-072</b>	30" Square Wood Table with 22" Legs	<b>\$150</b>



## 3 RUNG LADDERBACK CHAIRS

Available in five different sizes, this is the perfect chair for everyone! Solid hardwood 3 Rung Ladderback Chairs are sturdy and comfortable, with curved back legs to help reduce tipping. Ladderback design makes chairs easy to pick up and move, and leg rails along all four sides add strength and stability. Assembled chairs feature mortise and tenon construction.

*Must order case pack quantities of 2*

<b>ELR-15316</b>	10" Ladderback Chair	12.2"W x 13.3"D x 22.3"H	<b>\$70</b>
<b>ELR-15318</b>	12" Ladderback Chair	14"W x 13.3"D x 24.3"H	<b>\$75</b>
<b>ELR-15320</b>	14" Ladderback Chair	14"W x 13.5"D x 28.5"H	<b>\$80</b>
<b>ELR-15322</b>	16" Ladderback Chair	15.9"W x 15.8"D x 29"H	<b>\$105</b>
<b>ELR-15324</b>	18" Ladderback Chair	17.4"W x 16.6"D x 33"H	<b>\$120</b>

## 30" ROUND TABLE & CHAIR SET

Won't you join me for tea? Deluxe solid 30" Round Hardwood Table and Chair Set is just the place for little ones to read a book, build a spaceship out of blocks, or host a tea party. Perfect for home or school use, the table comes with two hardwood chairs for quality time with a best friend or favorite stuffed panda bear. Table features a 0.75" bull-nose edge and sturdy 1.75" square legs, and an easy-to-clean natural finish. Chairs are made of durable hardwood with curved back legs to help reduce tipping. Easy to assemble. 

*Must order in case pack quantities of 1*

Comes with (2) 12" RTA Chairs  
 Table: 30"Diameter x 22"H;  
 Chair: 14"W x 13.3"D x 24.3"H; Chair Seat: 12"H

**ELR-22101** 30" Round Table & Chair Set **\$220**



## STACKABLE WOODEN TODDLER CHAIRS

Toddlers will love sitting with the big kids in this chair! Durable hardwood chair is the perfect place for toddlers to sit and share a snack or read a book. Handles on the back and both sides make it easy to pick up, and fun for little ones to help, too. Chairs feature an easy-to-clean natural finish and rounded edges for safety. Easy to assemble, and stackable to save space. 

*Must order in case pack quantities of 2*

<b>ELR-18005</b>	6" RTA Toddler Chair	<b>\$50</b>
<b>ELR-18006</b>	8" RTA Toddler Chair	<b>\$52</b>
<b>ELR-18007</b>	10" RTA Toddler Chair	<b>\$54</b>



**NEW  
PRIMARY  
COLORS**



Tables & Chairs

## RESIN CHAIRS

Chairs in cheerful primary colors will brighten up your classroom, playroom, or outdoor space! Comfortable and sturdy, Resin Chairs are available in a variety of sizes to accommodate kids of all ages. Complementary colors mix and match to coordinate with Resin and Adjustable Activity Tables. Chairs are easy to clean and sanitize, and feature a one-piece design that requires no hardware or tightening—a classroom favorite! Made from fade-resistant polypropylene that won't chip or peel, with rounded edges for safety.

Must order in case pack quantities of 6

Colors: Blue (BL), Green (GN), Yellow (YE), Red (RD), or Sand (SD)

<b>NEW ELR-15410-XX</b>	10" Resin Chair	12.5"W x 13.4"D x 20.0"H	<b>\$16</b>
<b>NEW ELR-15412-XX</b>	12" Resin Chair	12.8"W x 14.8"D x 21.6"H	<b>\$18</b>
<b>NEW ELR-15414-XX</b>	14" Resin Chair	13.75"W x 16"D x 22.75"H	<b>\$24</b>
<b>NEW ELR-15416-XX</b>	16" Resin Chair	16"W x 17.3"D x 27.5"H	<b>\$34</b>

### Assorted Packs

Includes: 2 Blue (BL), 2 Red (RD), 1 Yellow (YE), and 1 Green (GN).

<b>NEW ELR-15134-AS</b>	10" Resin Chair	<b>\$96</b>
<b>NEW ELR-15135-AS</b>	12" Resin Chair	<b>\$108</b>
<b>NEW ELR-15136-AS</b>	14" Resin Chair	<b>\$144</b>
<b>NEW ELR-15137-AS</b>	16" Resin Chair	<b>\$204</b>

Must order in case pack quantities of 5

Colors: Black (BK), Navy (NV), Sand (SD)

<b>NEW ELR-15418-XX</b>	18" Resin Chair	18.25"W x 20.5"D x 31.5"H	<b>\$48</b>
-------------------------	-----------------	---------------------------	-------------

## RESIN TABLES

Designed to complement the Resin Chairs, colorful Resin Tables provide a versatile and fun space for work or play. Available in a variety of shapes to create an ideal group learning environment, tables are easy to clean and sanitize between science experiments and snack time. Tables feature a sturdy, reinforced steel frame and fade-resistant polyethylene surface that will not crack, chip or peel. Legs adjust in 1" increments from 13.25" to 22.25".

Must order in case pack quantities of 1

Colors: Blue (BL), Green (GN), Yellow (YE), Red (RD), or Sand (SD)

<b>NEW ELR-14405-XX</b>	48" Rectangular Resin Table	48"W x 24"D	<b>\$120</b>
<b>NEW ELR-14406-XX</b>	45" Round Resin Table	45" Diameter	<b>\$150</b>
<b>NEW ELR-14407-XX</b>	65" Kidney Resin Table	65"W x 35"D	<b>\$180</b>



### ADJUSTABLE LEGS

Legs adjust in 1" increments from 13.25" to 22.25", giving our resin tables a lot of distance in the height department.







## OPEN FRONT DESKS

Say hello to the classic open front desks you remember using in school! The ECR4Kids Open Front Desk with either Metal Book Box or Chrome Book Basket, has a proven design perfect for today's classrooms and homes. Students need a place to learn and grow, and the open front desks provide that environment. Desks are sold as 2-packs; an excellent solution for a large grouping or a small pairing solution.

The book boxes are also outfitted with an indented groove to keep pencils, pens, and the like from sliding around and from falling on to the floor. Let's keep our desks nice and tidy! The sleek chrome legs are adjustable in one inch increments. Start them off early with the desk at 24"H and watch as it grows along with your sprouting students. Desks can adjust from 24"H to 30.5"H.

Each leg is equipped with a nylon swivel glide to keep the ECR4Kids Open Front Desk well-adjusted under less than ideal flooring conditions. The glides help self-level desks, providing an easy solution for uneven flooring. 

*Must order in case pack quantities of 2*

*Surface Area: 24" x 18"*

*Height: 23.5" - 30.5" (in 1" increments)*

### NEW OPEN FRONT DESK WITH CHROME BOOK BASKET

**ELR-24102** Chrome Open Front Desk **\$150**

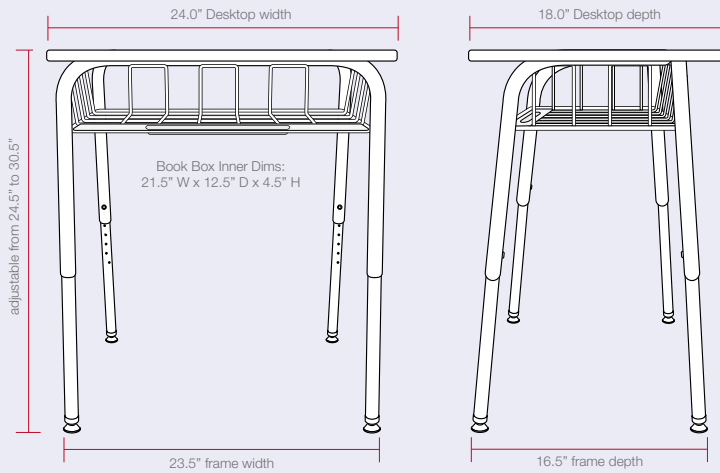

### OPEN FRONT DESK WITH METAL BOOK BOX

**ELR-24101** Metal Open Front Desk **\$102**

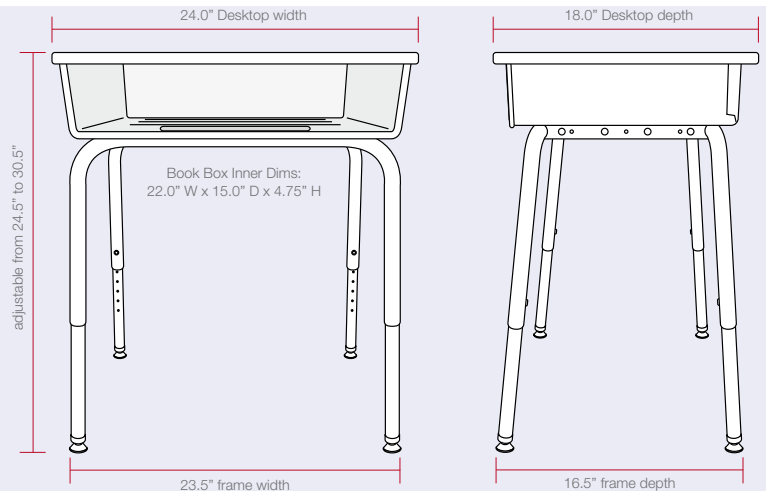



## Birch

### CASTERS

Hard Rubber Wheels, No Marring  
Zinc Plated Steel  
60lb Capacity per Caster

### PIANO HINGES

Full-Length Hinges for Added Safety and Durability

### EASY TO CLEAN

Stain Resistant

### ROUNDED EDGES

For Added Safety

### PRE-ASSEMBLED KICK PLATES

Simpler Assembly  
Sturdier Construction

### ADULT ASSEMBLY REQUIRED

### CARB CERTIFIED

### CPSIA COMPLIANT

### GREENGUARD CERTIFIED

Birch



## COAT LOCKERS

No more missing boots, lost coats, or classroom clutter! Birch hardwood coat lockers are the perfect place for children to store jackets, galoshes, lunch boxes, backpacks, and more. Cubbies hold hats, mittens, and special treasures brought from home.

Constructed using durable birch hardwood, coat lockers are available with or without a bench in the following versions: corner, 2-section, 5-section, or 10-section. The hardwood birch units feature an attractive natural finish with rounded edges for safety. For an attractive and functional addition to any coat locker, utilize ECR4Kids Scoop Front Bins; sold separately.

*Must order in case pack quantities of 1*  
 Compartments: 12" deep

*Image shown on the left is ELR-SPC-22201.*

<b>ELR-17230</b>	2-Section Locker	19.5"W x 13.5"D x 48"H	<b>\$220</b>
<b>ELR-17231</b>	2-Section Locker with Bench	19.5"W x 13.5"D x 48"H	<b>\$230</b>
<b>ELR-17232</b>	Corner Section Locker	26"W x 26"D x 48"H	<b>\$320</b>
<b>ELR-17233</b>	Corner Section Locker with Bench	26"W x 26"D x 48"H	<b>\$330</b>
<b>ELR-0425</b>	5-Section Coat Locker	54"W x 13"D x 48"H	<b>\$450</b>
<b>ELR-0453</b>	5-Section Coat Locker with Bench	54"W x 13"D x 48"H	<b>\$470</b>
<b>ELR-17300</b>	10-Section Double-Sided Locker	54"W x 26"D x 48"H	<b>\$740</b>
<b>ELR-17301</b>	10-Section Double-Sided Locker with Bench	54"W x 26"D x 48"H	<b>\$750</b>
<b>ELR-SPC-22201</b>	5-Section, 2-Section, and Corner Coat Lockers with Bench		<b>\$1,000</b>

## NEW 10-SECTION HANGING COAT LOCKER

Add this unit to your wall for extra storage space at school, or use it on its own at home! The ten-section hanging coat locker keeps coats, sweaters, and more off the floor and stored away nicely. Each unit features 10 hooks and 10 cubbies to accommodate the belongings for up to ten children. ECR4Kids Scoop Front Bin fit cubbies to keep smaller items from getting lost.

*Must order in case pack quantities of 1*

**ELR-17304** 48"W x 13"D x 20"H **\$230**



## NEW 16-SECTION STREAMLINE COAT LOCKER



The 16-Section Streamline Coat Locker is designed for maximum storage in a minimal space! Each level features coat hooks and eight tall thin cubbies to allow children to store their backpacks, jackets, umbrellas, boots, and more. The sleek design can accommodate the belongings for up to 16 children. The hardwood birch unit features an attractive natural finish with rounded edges for safety.

*Must order in case pack quantities of 1*

**ELR-17305** 60"W x 13"D x 48"H **\$520**

Birch

## FOLD & LOCK TRAY CABINETS WITH STORAGE

Versatile units display when open and close easily for weekend or summertime storage! Birch hardwood units swing open and shut on casters and feature a full-length piano hinge, making it easy to keep your classroom supplies organized and secure. Tray cabinets on one side accommodate ECR4Kids Scoop Front Bins to contain art supplies and loose items, shelves on the other side hold books, games, toys and more! Dimensions shown represent each side. Bins not included, except where noted with -XX. Casters included for optional mobility.  

Must order in case pack quantities of 1

Compartments: 12" deep.

Choose Bin colors: Assorted (AS), Clear (CL), or Desert Sand (SD)  
48"W x 13"D

- |                     |   |              |
|---------------------|---|--------------|
| <b>ELR-17216</b>    | Fold and Lock 15 Tray Cabinet & Storage 24"           | <b>\$600</b> |
| <b>ELR-17216-XX</b> | Fold and Lock 15 Tray Cabinet & Storage 24" with Bins | <b>\$660</b> |
| <b>ELR-17217</b>    | Fold and Lock 20 Tray Cabinet & Storage 30"           | <b>\$650</b> |
| <b>ELR-17217-XX</b> | Fold and Lock 20 Tray Cabinet & Storage 30" with Bins | <b>\$730</b> |
| <b>ELR-17218</b>    | Fold and Lock 25 Tray Cabinet & Storage 36"           | <b>\$750</b> |
| <b>ELR-17218-XX</b> | Fold and Lock 25 Tray Cabinet & Storage 36" with Bins | <b>\$850</b> |





**ELR-17216-CL**



**ELR-0427-SD**

## TRAY CABINETS

A favorite for classroom and home organization! Birch hardwood cabinets keep toys, art supplies, games and more neatly organized and stored away when not in use. Cubbies accommodate ECR4Kids Scoop Front Bins for easy access to smaller items and button collections. Bins not included, except where noted with -XX. Cabinets are available in a variety of sizes, with casters included for optional mobility.  

Must order in case pack quantities of 1

Compartments: 12" deep.

Choose Bin colors: Assorted (AS), Clear (CL), or Desert Sand (SD)

- |                     |                              |                      |              |
|---------------------|------------------------------|----------------------|--------------|
| <b>ELR-17215</b>    | 10 Tray Cabinet              | 19.5"W x 13"D x 36"H | <b>\$240</b> |
| <b>ELR-17215-XX</b> | 10 Tray Cabinet with 10 Bins | 19.5"W x 13"D x 36"H | <b>\$280</b> |
| <b>ELR-17252</b>    | 12 Tray Cabinet              | 38.5"W x 13"D x 24"H | <b>\$270</b> |
| <b>ELR-17252-XX</b> | 12 Tray Cabinet with 12 Bins | 38.5"W x 13"D x 24"H | <b>\$320</b> |
| <b>ELR-17209</b>    | 15 Tray Cabinet              | 48"W x 13"D x 24"H   | <b>\$300</b> |
| <b>ELR-17209-XX</b> | 15 Tray Cabinet with 15 Bins | 48"W x 13"D x 24"H   | <b>\$360</b> |
| <b>ELR-0426</b>     | 20 Tray Cabinet              | 48"W x 13"D x 30"H   | <b>\$330</b> |
| <b>ELR-0426-XX</b>  | 20 Tray Cabinet with 20 Bins | 48"W x 13"D x 30"H   | <b>\$410</b> |
| <b>ELR-0427</b>     | 25 Tray Cabinet              | 48"W x 13"D x 36"H   | <b>\$390</b> |
| <b>ELR-0427-XX</b>  | 25 Tray Cabinet with 25 Bins | 48"W x 13"D x 36"H   | <b>\$490</b> |

## MULTI-SECTION STORAGE CABINETS

Versatile birch hardwood cabinet has room for everything—paper, books, art supplies, tools and more! Cubbies accommodate Scoop Front Bins for easy storage, and smaller shelves are perfect for keeping papers organized. Bins not included, except where noted with -XX. Casters included for optional mobility.  

Must order in case pack quantities of 1

Compartments: 12" deep.

Choose Bin colors: Assorted (AS), Clear (CL), or Desert Sand (SD)  
48"W x 13"D x 36"H

- |                    |  |              |
|--------------------|--|--------------|
| <b>ELR-0428</b>    | Multi-Section Storage Cabinet              | <b>\$400</b> |
| <b>ELR-0428-AS</b> | Multi-Section Storage Cabinet with 15 Bins | <b>\$475</b> |
| <b>ELR-0428-CL</b> | Multi-Section Storage Cabinet with 15 Bins | <b>\$475</b> |
| <b>ELR-0428-SD</b> | Multi-Section Storage Cabinet with 15 Bins | <b>\$475</b> |



**ELR-0428-AS**

### Accessories



- |                    |                                       |            |
|--------------------|---------------------------------------|------------|
| <b>ELR-0482-XX</b> | Scoop Front Bins                      | <b>\$5</b> |
|                    | 8"W x 11.8"D x 5.3"H, Case pack of 10 |            |
|                    | * See page 35 for more information.   |            |

Actual colors may vary.

**NEW!**



**NEW 8 COMPARTMENT BACKPACK CUBBY UNIT**

Keep backpacks, sheets, blankets and toys organized and off the floor! Great for a classroom or daycare, the Eight Compartment Storage Unit accommodates a variety of ECR4Kids Storage Bins to keep smaller items from getting lost. The hardwood birch unit features an attractive natural finish with rounded edges for safety. Bins sold separately.

Must order in case pack quantities of 1  
Compartments: 12" Deep

**ELR-17253** 48"W x 13"D x 30"H **\$250**

**NEW CORNER STORAGE CABINETS**

The perfect complement to the ECR4Kids Storage Cabinets ELR-0419, ELR-0420, and ELR-0421! The Corner Storage Cabinet connects two storage units to maximize your tidying capabilities by utilizing unused space. The hardwood birch unit features an attractive natural finish with rounded edges for safety. The cabinet is available in your choice of 24", 30", or 36" height to complement the five or eight compartment ECR4Kids Storage Units. Four casters, two locking, are include for mobility.

Must order in case pack quantities of 1  
Compartments: 12" Deep

- ELR-17206** 24" Corner Storage Cabinet 30"W x 30"D x 24"H **\$220**
- ELR-17207** 30" Corner Storage Cabinet 30"W x 30"D x 30"H **\$240**
- ELR-17208** 36" Corner Storage Cabinet 30"W x 30"D x 36"H **\$280**



**NEW!**



**STORAGE CABINETS**

Birch hardwood storage cabinets are just the place to keep books, toys and games organized—perfect for use in school and at home! Units are available with either five or eight compartments, which accommodate ECR4Kids storage bins for easy storing of odds and ends. Casters included for mobility. Bins not included.

Must order in case pack quantities of 1  
Compartments: 12" Deep

- ELR-0419** 5 Compartment 48"W x 13"D x 24"H **\$230**
- ELR-0420** 5 Compartment 48"W x 13"D x 30"H **\$250**
- ELR-0421** 8 Compartment 48"W x 13"D x 36"H **\$300**

**FOLD & LOCK CABINETS**

Folding cabinets keep toys, games, books and supplies organized and ready to go! Birch hardwood units have five or eight compartments on each side, and accommodate our storage bins for holding loose items. Cabinets swing open and shut on casters for easy and secure storage, and feature a full-length piano hinge. Dimensions shown represent each side. Bins not included. Casters included for mobility.

Must order in case pack quantities of 1  
Compartments: 12" Deep

- ELR-0422** 5 Compartment 48"W x 13"D x 24"H **\$510**
- ELR-0423** 5 Compartment 48"W x 13"D x 30"H **\$550**
- ELR-0424** 8 Compartment 48"W x 13"D x 36"H **\$640**





**SEE & STORE BENCH**

Have a seat! The See & Store Bench features three mobile storage bins with acrylic windows for easy access to games and toys, and a soft cushion seat for reading or playing. Multi-purpose bench is perfect for use at home or in school. Casters included for mobility.

Must order in case pack quantities of 1

Bins: 13.25"W x 14.5"D x 16"H

**ELR-0698** 48"W x 17.25"D x 18.75"H

**\$400**

**SEE & STORE ACTIVITY TABLE**

The perfect combination of form and function! See & Store Activity Table is just the place for building and playing, and six mobile storage bins with acrylic windows will keep toys and blocks right at hand. When it's time to clean up, bins slide under the table and out of the way.

Must order in case pack quantities of 1

Bins: 13.25"W x 14.5"D x 16"H

**ELR-0697** 46"W x 33.5"D x 17.5"H

**\$650**



**SEE & STORE SHELF**

At home or at school, the See & Store Shelf stands out as a favorite! Sturdy birch hardwood keeps toys, games, and clutter organized and out of the way, with three deep shelves and three storage bins tucked neatly below. Clear acrylic windows on the bins let little ones see what's inside, and bins move easily in and out of cubbies so everyone can help put the toys away at the end of the day.

Must order in case pack quantities of 1

Bins: 13.25"W x 14.5"D x 16"H

**ELR-0696** Shelf

8"W x 17.75"D x 28.5"H

**\$500**



**SEE THROUGH STORAGE**

Little ones can keep an eye on their favorite toys even after they're put away in this hardwood storage unit. Three deep compartments with sturdy, clear acrylic windows keep games and toys organized. Side handles and optional casters make it easy to move the unit across the room or across the hall—wherever toys are needed!

Must order in case pack quantities of 1

Bins: 13.25"W x 14.5"D x 16"H

**ELR-0699** 32"W x 16"D x 16"H

**\$170**



**2 SHELF STORAGE CABINETS**

Birch hardwood shelving unit makes it easy to organize your classroom or child's room. Sturdy, 12" deep compartments are perfect for books, toys, games, and more! This cabinet comes with your choice of a back for use against a wall or without to see contents from both sides. Casters included for mobility.

Must order in case pack quantities of 1

36"W x 13"D x 26"H

**ELR-0450** 2 Shelf Storage Cabinet with Back

**\$190**

**ELR-0451** 2 Shelf Storage Cabinet without Back

**\$180**



**ELR-0450**

**NEW!**



**NEW CANVAS BOOK DISPLAYS**

Display your children's favorite stories using the ECR4Kids Fabric Book Display. Available as either a single (5-pocket) or double-sided (10-pocket) version, the extremely lightweight display is a great alternative to a traditional heavy hardwood book shelf. The durable birch frame features an attractive neutral canvas rather than the traditional wooden shelving to show books. The ECR4Kids Fabric Book Display can easily be moved from room to room.

Must order in case pack quantities of 1

<b>ELR-17108</b>	Single-Sided	28"W x 13"D x 28"H	<b>\$110</b>
<b>ELR-17109</b>	Double-Sided	28"W x 24"D x 28"H	<b>\$200</b>

**NEW!**



**NEW HELPFUL LITTLE TEACHER STOOL**

The durable birch hardwood Teachers Stool is the perfect addition to any classroom for story or circle time. Two convenient shelves and a cubby below allow teachers to keep books and supplies stored within reach. Two side pockets and a hook and loop pouch complement the comfortable 2" thick cushion in an attractive neutral canvas. The ECR4Kids Helpful Little Teacher Stool includes four casters for mobility.

Must order in case pack quantities of 1

<b>ELR-15327</b>	16"W x 16"D x 18"H	<b>\$150</b>
------------------	--------------------	--------------

**BOOK DISPLAY WITH STORAGE**

The Book Display with Storage has a trick up its sleeve! Shelves keep books organized and on display on one side, and compartments on the other side provide extra storage for toys, games, and more. Birch hardwood unit features five easy-to-reach shelves and two 12" deep compartments that accommodate our storage bins.

Must order in case pack quantities of 1

<b>ELR-0429</b>	Book Display with Storage	36"W x 24"D x 30"H	<b>\$300</b>
<b>ELR-17103</b>	Display and Store Mobile Cart	36"W x 20"D x 34"H	<b>\$350</b>



**ELR-0429**

**TODDLER BOOK DISPLAY**

The ECR4Kids Toddler Book Display is perfect for displaying and storing books. Ideal for small spaces, that toddler book display can be placed on a table or on the ground for little ones to access. Birch hardwood unit features four easy-to-reach shelves.

<b>ELR-17104</b>	30"W x 16"D x 14"H	<b>\$130</b>
------------------	--------------------	--------------



## BOOK DISPLAYS

Little ones can see all of their favorite books on display in easy-to-reach shelves that make story time simple. Book displays are made of birch hardwood and have smooth edges for safety. Choose single or double-sided. Double-Sided Book Display comes with casters for mobility. 

Must order in case pack quantities of 1

<b>ELR-0335</b>	Double-Sided Book Display	36"W x 19"D x 30"H	<b>\$220</b> 
<b>ELR-0339</b>	Single-Sided Book Display	36"W x 15"D x 30"H	<b>\$175</b>



**ELR-0335**



## CLASSIC BIRCH BOOKCASES

Children's favorite books and toys are right at home on these sturdy birch bookcases. Available in three heights with adjustable shelves to accommodate keepsakes of all shapes and sizes. Bookcases feature an integrated anti-tipping wall mounting bracket, and a pre-assembled reinforced base for extra durability and simpler assembly! Shelves adjust on a 1.25" spacing. All units are 36"W x 12"L with your choice of 36", 48", or 60" height. The base shelf of each bookcase measures 10.25" deep; all other shelves have a depth of 11". 

Must order in case pack quantities of 1

<b>ELR-17100</b>	36"H Bookcase	<b>\$240</b>
<b>ELR-17101</b>	48"H Bookcase	<b>\$260</b>
<b>ELR-17102</b>	60"H Bookcase	<b>\$340</b>

## PICK-A-BOOK STAND

When inspiration strikes, this book stand is ready! Children can choose their favorite books on one side, and draw new stories and pictures on the other. Perfect for games or reading lessons. Birch hardwood unit features five easy-to-reach bookshelves, and a white board on the reverse side with storage cubby underneath for markers and erasers. Unit has smooth edges for safety. 



Must order in case pack quantities of 1

<b>ELR-083</b>	32"W x 16"D x 27.50"H	<b>\$180</b>
----------------	-----------------------	--------------



Actual colors may vary.

## BIG BOOK DISPLAY AND STORAGE

Bring something special to your reading circle! Birch hardwood display unit stores oversized books and posters, and a display shelf holds an open book for everyone to see. Your hands will be free to bring story time to life on the dry-erase activity board. Use as a storage unit or as a podium when folded down. Casters included for mobility.  

Must order in case pack quantities of 1  
24.5"W x 15.25"D x 30.25"H

<b>ELR-0690</b>	Big Book Display and Storage - Dry-Erase Board	<b>\$250</b>
-----------------	--	--------------





**BENTWOOD COMFORT FURNITURE**

Everyone can have a seat on these comfortable Bentwood Chairs. Single, double, and adult size birch hardwood chairs are perfect for reading or chatting about your day together. Removable cushions are filled with 1.5" thick foam. Braces on the legs help reduce tipping. 75lb. weight limit for children's chairs, 250lb. for the adult comfort chair.

Must order in case pack quantities of 1

Chair: 17"W x 19"D x 25"H, Double Chair: 31.5" x 19"D x 26.50"H, Table: 11"DIA x 11.75"H

<b>ELR-0344</b>	3 pc Chairs with Table Set (2 Single Chairs w/ Table)	<b>\$125</b>
<b>ELR-0345</b>	Double Chair	<b>\$105</b>
<b>ELR-0368</b>	4 pc Combo Comfort Set (1 Double Chair, 2 Single Chairs & Table)	<b>\$220</b>
<b>ELR-15501</b>	Adult Comfort Chair 26.75"W x 26"D x 42"H	<b>\$130</b>
<b>NEW ELR-SPC-15405</b>	5 pc Combo Comfort Set (1 Adult Comfort Chair, 1 Double Chair, 2 Single Chairs & Table)	<b>\$360</b>

**PLAYHOUSE CUBE**

Little ones will love this fun Playhouse Cube! It makes a perfect reading nook for two, but at playtime it quickly transforms into a secret hideaway, a rocket ship, or a dragon's lair. Birch hardwood cube has solid panels on top, bottom and back, with three fun circular cutouts for doors.

Must order in case pack quantities of 1  
30"W x 30"D x 30.5"H

<b>ELR-17500</b>	Playhouse Cube Frame	<b>\$270</b>	
<b>ELR-17506</b>	Playhouse Cube Frame with Mat	<b>\$320</b>	
<b>ELR-16200</b>	Mat	28"W x 28"D x 1"H	<b>\$50</b>



**DISCOVERY COVE**

Is it a house? A bear's cave? A tent on top of Mount Everest? Imaginations will soar in the ECR4Kids Discovery Cove playhouse. Birch hardwood unit features a magical hidden play area with two shelf storage units on either side for holding important expedition supplies. Removable, washable curtains. Intended for indoor use only.

Must order in case pack quantities of 1  
80"W x 37"D x 49.75"H

<b>ELR-0452</b>	<b>\$470</b>
-----------------	--------------



Birch



## PLAY KITCHEN

This Play Kitchen has everything young chefs need to whip up a culinary masterpiece! Little ones will love cooking in this fun and realistic birch kitchen set that's just their size. And parents will love it even more as it arrives fully assembled! Stove has four burners, six rotating knobs, an acrylic window and interior shelf perfect for make believe birthday cakes. Sink features water sprayer, turn faucet, and storage shelves. Cupboard and refrigerator include storage shelves for dishes and ingredients. Kitchen set features magnetic closures with full-length piano hinges. The 4-in-1 Kitchen includes a stove, sink, microwave oven, and cupboard.

Must order in case pack quantities of 1

<b>ELR-0430</b>	Play Stove	20"W x 15"D x 26.75"H	<b>\$220</b>
<b>ELR-0431</b>	Play Sink	20"W x 15"D x 26.75"H	<b>\$220</b>
<b>ELR-0432</b>	Play Cupboard	20"W x 15"D x 35.25"H	<b>\$230</b>
<b>ELR-0433</b>	Play Refrigerator	20"W x 15"D x 35.25"H	<b>\$240</b>
<b>ELR-0434</b>	4-in-1 Kitchen	35.75"W x 15"D x 35.25"H	<b>\$420</b>
<b>ELR-0501</b>	4 pc Kitchen Set	Stove, Sink, Cupboard, Refrigerator	<b>\$880</b>



**ELR-0434**

## 4 PIECE LIVING ROOM SET

At the end of a long day, little ones can sit down and relax in their very own living room. Perfect for home, school, or office use, durable birch hardwood seating makes a fun and comfortable place to read or play. Coffee table and end table keep books and games handy. Seating features cushions filled with 2" thick foam and vinyl covers that are easy to clean. 

Must order in case pack quantities of 1

<b>ELR-0681</b>	Sofa	37.25"W x 20"D x 25.25"H	<b>\$270</b>
<b>ELR-0682</b>	Chair	19.75"W x 20"D x 22.50"H	<b>\$170</b>
<b>ELR-0683</b>	Coffee Table	25"W x 15"D x 13"H	<b>\$70</b>
<b>ELR-0684</b>	End Table	15"W x 15"D 13"H	<b>\$60</b>
<b>ELR-0680</b>	4 pc Living Room Set		<b>\$550</b>



Actual colors may vary.

©2015 ECR4KIDS



**DRESS UP ISLAND**

Is there a doctor in the house? Birch hardwood rack keeps dress up clothes on hand and ready for action on a moment's notice. Features 10 hooks (five on each side), top shelf for smaller items, shoe tray in the base, and full length acrylic mirrors on both ends. Casters included for mobility.

Must order in case pack quantities of 1  
48"W x 14"D x 35"H

**ELR-0700 \$240**

**DOUBLE-SIDED BI-DIRECTIONAL MIRROR**

Little monsters and fairy zebra princesses will love to see themselves dressed up in this full-length mirror! Birch hardwood frame, with double-sided safety mirrors. Mirror easily changes from horizontal to vertical orientation with removable feet.

Must order in case pack quantities of 1  
14.50"W x 16"D x 48"H

**ELR-0701 \$145**



**DRESS UP CAROUSEL**

Take this carousel for a spin, and let playtime begin! Revolving carousel keeps dress up clothes on hand and organized. Birch hardwood unit features coat hooks, storage cubbies, two large storage bins, and two full-length mirrors.

Must order in case pack quantities of 1  
20"W x 20"D x 50.25"H

**ELR-0702 \$300**



**PUPPET THEATER**

It's opening night! All the world's a stage for little performers with this sturdy and fun Puppet Theater. Great for playtime, theater includes stage curtains, with marquee board above and presentation board below the "stage." Choose either Flannel or Dry-Erase boards. Made from birch hardwood.

Must order in case pack quantities of 1  
49"W x 20"D x 49"H

**ELR-0693** Puppet Theater - Flannel **\$300**  
**ELR-0695** Puppet Theater - Dry-Erase Board **\$300**



**ELR-0693**



## Colorful Essentials

### CASTERS

Hard Rubber Wheels, No Marring  
Zinc Plated Steel  
60lb Capacity per Caster

### PIANO HINGES

Full-Length Hinges for Added Safety and Durability

### EASY TO CLEAN

Stain Resistant Laminate

### ROUNDED EDGES

For Added Safety

### PRE-ASSEMBLED KICK PLATES

Simpler Assembly  
Sturdier Construction

### CARB CERTIFIED

### CPSIA COMPLIANT

### GREENGUARD CERTIFIED

### ADULT ASSEMBLY REQUIRED

### MAPLE WITH SIDE PANEL COLOR OPTIONS:



Red - RD



Blue - BL

28



ELR-0713-RD

### 5-SECTION COAT LOCKER WITH BENCH

No more missing boots, lost coats, or classroom clutter! Coat lockers are the perfect place for children to store jackets, boots, lunch boxes, backpacks, and more. Cubbies hold hats, mittens, and special treasures brought from home. Each unit features 10 coat hooks and five cubbies above and below to accommodate belongings for up to 10 children. Bench seat for easy on-off of shoes and boots. Lockers feature a maple finish with your choice of side panel accent color. Bins sold separately.

Must order in case pack quantities of 1  
Colors: Blue (BL) or Red (RD)

**ELR-0714-XX** 54"W x 15.75"D x 47.25"H **\$450**

### STORAGE CABINETS

Our storage cabinets are just the place to keep books, toys and games organized—perfect for use in school and at home! Easy-to-clean stain resistant laminate cabinets feature a maple finish, with your choice of side panel accent color. Available with either five or eight compartments with three heights, which accommodate our storage bins for easy storing of odds and ends. Compartments measure 14" deep to accommodate a variety of items. Bins not included.

Must order in case pack quantities of 1  
Colors: Blue (BL) or Red (RD)

<b>ELR-0711-XX</b>	5 Compartment	48"W x 15.75"D x 24"H	<b>\$230</b>
<b>ELR-0712-XX</b>	5 Compartment	48"W x 15.75"D x 30"H	<b>\$250</b>
<b>ELR-0713-XX</b>	8 Compartment	48"W x 15.75"D x 36"H	<b>\$300</b>



ELR-0715-RD

### MULTI-PURPOSE CABINETS

Perfect for use at home or in the classroom! Maple finish cabinets accommodate trays to keep toys, games, craft supplies, and more organized and easily accessible. Easy-to-clean stain resistant laminate with your choice of side panel accent color. Casters included for mobility. Trays sold separately.

Must order in case pack quantities of 1  
Colors: Blue (BL) or Red (RD)

<b>ELR-0715-XX</b>	18 Compartment	48"W x 15.75"D x 36"H	<b>\$340</b>
<b>ELR-0716-XX</b>	3-Level Cabinet	48"W x 15.75"D x 36"H	<b>\$280</b>
<b>ELR-0726-XX</b>	12 Compartment	48"W x 15.75"D x 36"H	<b>\$300</b>

### BOOK STAND WITH STORAGE

Single-sided book stands offer easy-to-reach shelves. Standard book stand offers four additional storage cubbies at the bottom. Easy-to-clean stain resistant laminate. Features a maple finish with your choice of side panel accent color.

Must order in case pack quantities of 1  
Colors: Blue (BL) or Red (RD)

<b>ELR-0720-XX</b>	Single-Sided Standard	47.25"W x 12"D x 35.50"H	<b>\$275</b>
<b>ELR-0721-XX</b>	Single-Sided Toddler	35.50"W x 12"D x 23"H	<b>\$225</b>



ELR-0720-RD

# Book Displays

Colorful Essentials

## 2-SIDED BOOK STAND

Little ones can easily find their favorite books and toys on this double-sided book stand. Shelves along the top hold books in place, cubbies below hold everything else! Available in standard and toddler size. Warm maple finish laminate with your choice of side panel accent color. Bins not included. 

Must order in case pack quantities of 1  
Colors: Blue (BL) or Red (RD)

<b>ELR-0717-XX</b>	Double-Sided Standard	48"W x 20"D x 36"H	<b>\$350</b>
<b>ELR-0718-XX</b>	Double-Sided Toddler	36"W x 20"D x 24"H	<b>\$200</b>



**ELR-0717-BL**



**ELR-0728-RD**

## BOOK DISPLAY WITH STORAGE

Books, toys, and games stay organized all in one place. Single-sided book display has four easy-to-reach shelves to keep favorite books, with additional storage cubbies below for puzzles, blocks, and more. Choose three or six storage compartments. Easy-to-clean laminate in maple finish, with your choice of side panel accent color. Bins not included. 

Must order in case pack quantities of 1  
Colors: Blue (BL) or Red (RD)

47.25"W x 15.75"D x 35.50"H

<b>ELR-0727-XX</b>	6 Compartment Book Display with Storage	<b>\$250</b>
<b>ELR-0728-XX</b>	3 Compartment Book Display with Storage	<b>\$250</b>

## BIG BOOK DISPLAY

The Big Book Display keeps everyone's favorite books organized and ready for story time! Single-sided unit with four shelves. Easy-to-clean stain resistant laminate in maple finish, with your choice of side panel accent color. 

Must order in case pack quantities of 1  
Colors: Blue (BL) or Red (RD)





35.50"W x 16"D x 31.75"H







<b>ELR-0719-XX</b>	<b>\$200</b>
--------------------	--------------



30

### Accessories

	<b>ELR-0722-XX</b> Large Storage Bin 10.25"W x 13.75"D x 8.25"H, Case pack of 20	<b>\$10</b>
	<b>ELR-0723-XX</b> Large Storage Bin with Lid 10.25"W x 13.75"D x 8.25"H, Case pack of 20	<b>\$12</b>
	<b>ELR-0724-XX</b> Small Storage Bin 10.25"W x 13.75"D x 4.25"H, Case pack of 20	<b>\$8</b>
	<b>ELR-0725-XX</b> Small Storage Bin with Lid 10.25"W x 13.75"D x 4.25"H, Case pack of 20	<b>\$10</b>

	<b>ELR-0800-XX</b> Square Tray	<b>\$16</b>
	<b>ELR-0801-XX</b> Square Tray with Lid 15"W x 15"D x 6.9"H, Case pack of 20	<b>\$18</b>
	<b>ELR-0802-XX</b> Quarter Circle Tray	<b>\$16</b>
	<b>ELR-0803-XX</b> Quarter Circle Tray with Lid 15"W x 15"D x 6.9"H, Case pack of 20	<b>\$18</b>
	<b>ELR-0804-XX</b> Fan Tray	<b>\$16</b>
	<b>ELR-0805-XX</b> Fan Tray with Lid 22"W x 16"D x 6.9"H, Case pack of 20	<b>\$18</b>

Actual colors may vary.

©2015 ECR4KIDS



**PLAY KITCHEN**

Play kitchens built to endure endless hours of fun! Little ones will love being master chefs in this realistic kitchen set. Doors have see-through panels, full length piano hinges, and rounded edges for added safety. Stove includes removable "hot" burner covers. Easy-to-clean stain resistant laminate in maple finish with your choice of accent color.

Must order in case pack quantities of 1

Colors: Blue (BL) or Red (RD)

<b>ELR-0744-XX</b>	Play Washer/Dryer	15.75"W x 15.75"D x 36"H	<b>\$180</b>
<b>ELR-0745-XX</b>	Play Cupboard	23.75"W x 15.75"D x 36"H	<b>\$200</b>
<b>ELR-0746-XX</b>	Play Stove	15.75"W x 15.75"D x 22.75"H	<b>\$140</b>
<b>ELR-0747-XX</b>	Play Sink	15.75"W x 15.75"D x 22.75"H	<b>\$140</b>
<b>ELR-0748-XX</b>	Play Refrigerator	15.75"W x 17"D x 34.75"H	<b>\$180</b>
<b>ELR-0749-XX</b>	Play Microwave Oven	15.75"W x 15.75"D x 22.75"H	<b>\$140</b>
<b>ELR-17504-XX</b>	4 pc Kitchen Set	Cupboard, Stove, Sink, Refrigerator	<b>\$660</b>
<b>ELR-17505-XX</b>	5 pc Kitchen Set	Cupboard, Stove, Sink, Refrigerator, Microwave	<b>\$800</b>



**ELR-0744-RD**

**31**



**4-IN-1 PLAY KITCHEN**

Everything you need to cook up a delicious feast! Play kitchen includes a two door refrigerator/freezer, sink with basin, shelves for storage, and a stove. Stove has removable "hot" burner covers and oven features a see-through window to keep an eye on your soufflé. Easy-to-clean laminate in maple finish with your choice of accent color.

Must order in case pack quantities of 1

Colors: Blue (BL) or Red (RD)  
47.25"W x 17.50"D x 37.25"H

**ELR-0750-XX \$350**



## STACKABLE KIDDIE COTS

Cheerful cots in primary colors make rest time a happy time! Little ones will be cozy and comfortable on wipe able fabric that fits tightly to the corners with minimal gaps. Cots stack to save space when not in use. Each cot features powder coated steel poles and sturdy plastic corners, and conforms to CA-117 guidelines. Intended for use by children as a rest cot only. Choose assembled or ready-to-assemble (RTA). Cot casters sold separately.

Standard: 52"W x 23"D x 5"H; Toddler: 40"W x 23"D x 5"H

Only available in Blue (BL)

<b>ELR-010-5</b>	Standard - Assembled	Single	<b>\$55</b>
<b>ELR-0231-5</b>	Toddler - Assembled	Single	<b>\$52</b>
<b>ELR-16111-BL</b>	Standard - Assembled	Case pack of 5	<b>\$48</b>
<b>ELR-16112-BL</b>	Standard - RTA	Case pack of 6	<b>\$42</b>
<b>ELR-16113</b>	Toddler - Assembled	Case pack of 5	<b>\$44</b>
<b>ELR-16114</b>	Toddler - RTA	Case pack of 6	<b>\$38</b>
<b>ELR-16121</b>	Standard with Cot Sheet - RTA	Case pack of 6	<b>\$48</b>
<b>ELR-16122</b>	Toddler with Cot Sheet - RTA	Case pack of 6	<b>\$44</b>

Colors: Green (GN), Red (RD), Yellow (YE), Sand (SD).

<b>NEW ELR-16125-XX</b>	Standard - Assembled	Single	<b>\$55</b>
<b>NEW ELR-16126-XX</b>	Standard - Assembled	Case pack of 5	<b>\$48</b>
<b>NEW ELR-16127-XX</b>	Standard - RTA	Case pack of 6	<b>\$42</b>
<b>NEW ELR-16128-AS</b>	Standard - Assembled	Set of 4: BL, GN, RD, YE	<b>\$192</b>
<b>NEW ELR-16129-AS</b>	Standard - Assembled	Set of 5: BL, GN, RD, YE, SD	<b>\$240</b>



## STREAMLINE COTS

Cozy, comfortable rest cots will have little ones drifting off to dreamland in no time. Soft, wipeable fabric is stretch-resistant and fits tightly to the corner with NO gaps. Cots stack to save space—streamline cots take up 20% less vertical space than standard cots (can stack six high in the same space as five standard cots). Fabric attaches with loop & lock closures at both ends. Cots feature powder coated steel poles with plastic ends. 5" H. Intended for use by children as a rest cot only.

Must order in case pack quantities of 6  
Standard: 52"W x 23"D x 5"H; Toddler: 40"W x 23"D x 5"H  
Color: Blue

<b>ELR-16118</b>	Standard Streamline Cot - RTA	<b>\$44</b>
<b>ELR-16117</b>	Standard Streamline Cot - Assembled	<b>\$50</b>
<b>ELR-16120</b>	Toddler Streamline Cot - RTA	<b>\$40</b>
<b>ELR-16119</b>	Toddler Streamline Cot - Assembled	<b>\$46</b>

Single - Case pack of 1 each

<b>ELR-16123</b>	Standard - Assembled	<b>\$60</b>
<b>ELR-16124</b>	Toddler - Assembled	<b>\$54</b>



**ELR-16120**

Accessories		
Cot casters work with both Streamline and Stackable Kiddie Cots		
	<b>ELR-023</b> Cot Caster Set	<b>\$15</b>
<i>Set of 4 caster for use with any ECR4Kids cots</i>		
	<b>ELR-0234</b> Toddler Cot Sheet	<b>\$9</b>
<i>40"L x 21.75"W, Case pack of 12</i>		
	<b>ELR-024</b> Standard Cot Sheet	<b>\$10</b>
<i>48"L x 21.75"W, Case pack of 12</i>		
	<b>ELR-026</b> Rest Time Blanket	<b>\$13</b>
<i>58"L x 36"W, Case pack of 12</i>		

Actual colors may vary.





## RAINBOW REST MATS

Little ones will dream of rainbows when they curl up on these mats at rest time! Bright, colorful mats are strong, durable, and comfortable. Each mat measures a full 2" thick, with a resilient, furniture-density foam core, and heavyweight waterproof 14-mm vinyl covering with polyester backing. Mats feature inside stitching for smooth edges, and a built-in clear plastic name tag holder. Rainbow Rest Mats are available in your choice of a 5 piece assorted set or a five pack of solid colors.

*Must purchase in case pack quantities of 1*  
 Colors: Blue (BL), Green (GN), Purple (PU), Red (RD), Yellow (YE) and Assorted (AS)  
 48"W x 22"D x 2"H

**ELR-0573-XX** Rainbow Rest Mats - 5 Pc Set **\$175**



Accessories		
	<b>ELR-16202</b> Rest Mat Sheet 48"L x 24"W, Case pack of 10	<b>\$10</b>

## FOLDING REST MAT

Comfortable, durable mats fold easily and stay out of the way when not in use. Available in your choice of three fold or four fold, mats are heat sealed and feature a built-in clear plastic name tag holder. Resilient 18kg/M3 density foam and easy-to-clean vinyl covering.

*Must purchase in case pack quantities of 5*  
 Colors: Double-Sided (Blue & Red)

**ELR-0574** 1" Thick - 3 Fold Mat 48"W x 24"D x 1"H **\$26**  
**ELR-0575** 2" Thick - 3 Fold Mat 48"W x 24"D x 2"H **\$36**  
**ELR-0576** 2" Thick - 4 Fold Mat 48"W x 24"D x 2"H **\$36**



## REST MAT TROLLEY



When rest time is over, little ones can help put their mats away on this trolley. Convenient, mobile storage unit holds 40 1"-thick mats or 20 2"-thick mats that measure up to 25"L x 50"W. Steel framed trolley has six casters for mobility, with four locking casters for safety. ECR4Kids Rainbow Rest Mats are sold separately. 

*Must purchase in case pack quantities of 1*  
 51"W x 27"D x 49.25"H

**ELR-0668** **\$170**

## MOBILE ORGANIZERS

The ECR4Kids Mobile Organizers are designed to make organizing your life easier and more attractive. Each drawer is carefully thought out in size, weight capacity and ease of use to make storing your belongings quick and stress-free. Don't forget about the additional surface area on top for easy access! The compact size of this organizer features significant storage in a small footprint. This makes it possible to fit almost anywhere, keeping your files, papers, art supplies, crafts, tools, toys, and more safely stored away.

Each mobile organizer has a steel frame and rails that are designed to withstand continuous use. Our products are tested to ensure drawers slide in and out effortlessly, staying on their tracks, with knobs securely in place. Two of the four casters are locking to hold the unit firmly in place. To move the organizer, simply unlock the casters and roll it to the next location! Cart capacity is 50 lbs (23kg).  

Must purchase in case pack quantities of 1

Drawer Dimensions: 11.25"W x 15.4"D x 2.75"H (Standard), 11.25"W x 15.4"D x 5.25"H (Extra-Deep)

Choose Drawer Colors: Assorted (AS) or Smoke (SM), or White (WH)

<b>ELR-20102-XX</b>	6 Drawer Mobile Organizer	Frame: 12.75"W x 15.4"D x 32"H	<b>\$72</b>
<b>ELR-009-XX</b>	10 Drawer Mobile Organizer	Frame: 12.75"W x 15.4"D x 38"H	<b>\$90</b>
<b>ELR-0261-XX</b>	12 Drawer Mobile Organizer	Frame: 24.75"W x 15.4"D x 25.75"H	<b>\$115</b>
<b>ELR-20104-XX</b>	12 Drawer Mobile Organizer	Frame: 24.75"W x 15.4"D x 31.75"H	<b>\$150</b>
<b>ELR-20101-XX</b>	14 Drawer Mobile Organizer	Frame: 24.75"W x 15.4"D x 31.75"H	<b>\$150</b>
<b>ELR-20103-XX</b>	15 Drawer Mobile Organizer	Frame: 24.75"W x 15.4"D x 38"H	<b>\$170</b>
<b>ELR-011-XX</b>	20 Drawer Mobile Organizer	Frame: 24.75"W x 15.4"D x 38"H	<b>\$170</b>



## UNIVERSAL ROLLING CART AND ORGANIZER BAG

Perfect for carrying school supplies, files, classroom equipment and more! Cart accommodates letter or legal size folders, hanging files, and binders, and features built-in hand grips for easy moving and lifting. Double rails lock sides securely. The saddlebag-style canvas cover features over 46 different storage compartments, and can be easily added or removed from the cart. Pockets have zipper and hook & loop closures for securing supplies and files during travel. Cart folds flat to 3"! Telescoping handle extends to 23" from the cart and locks in three positions for easy mobility on rubber wheels. Cart capacity is 65 lbs (29 kg). Accessories not included. 

Must purchase in case pack quantities as listed after each item description

Cart: 16.5"W x 15"D x 16"H

Bag: 17"W x 16"D x 2.1"H

<b>ELR-0547</b>	Universal Rolling Cart in Retail Packaging - case pack of 4	<b>\$40</b>
<b>ELR-0547B</b>	Universal Rolling Cart in Brown Box - case pack of 1	<b>\$40</b>
<b>ELR-0549</b>	Universal Rolling Cart and Organizer Bag in Retail Packaging - case pack of 3	<b>\$65</b>
<b>ELR-0549B</b>	Universal Rolling Cart and Organizer Bag in Brown Box - case pack of 1	<b>\$65</b>



Actual colors may vary.

©2015 ECR4KIDS

### 4-TIER STORAGE ORGANIZER WITH BINS

Bright, colorful storage rack keeps toys and games ready for playtime! Perfect for use at home or in school, easy-to-reach shelves with assorted bins hold loose items and supplies. Eight small and four large scoop front bins are easy for little hands to carry. Blue rack features metal support bars for durability. Organizer feet are specifically designed for stability to keep everything upright while bins and their contents get tossed around. Convenient cut out handles located on each side help to easily move around the organizer.

Must order in case pack quantities of 1

**ELR-20401** 37.5"W x 14"D x 33"H **\$140**



### 3-TIER STORAGE ORGANIZER WITH BINS

Organize and decorate your classroom or playroom with this functional storage solution from ECR4Kids. The sturdy rack is easy-to-clean, has rounded edges for safety, built-in handle cut-outs for easy mobility, and steel reinforced cross-bars for added strength and durability. Children will appreciate clean-up time for their toys with this 12-bin organizer. The rack has a low profile so kids can easily access the bins. Each bin is colorful, transportable, and can be positioned two ways. The organizer has three tiers and four bin colors, so children can create their own colorful combinations of blue, red, green and yellow.

Must order in case pack quantities of 1

**ELR-0216** 37.5"W x 14"D x 27.5"H **\$100**

### STACKABLE STORAGE TRUNK

Brightly colored storage trunks are perfect for stowing toys and supplies. 18-gallon trunks have matching dome lids and locking handles, and stack easily to save space! Four 360-degree casters are included for mobility. Four piece set includes one each: blue, green, red, and yellow.

Must order in case pack quantities of 1

**ELR-0167** 27.25"W x 13.5"D x 17.25"H **\$150**



### MAGNETIC DRY-ERASE BOARD SET

An essential for school, home, and office! Magnetic dry-erase board is great for notes, messages, lists, photos and more. Board features a sturdy aluminum frame, and Versa-Trak hanging system for easy mounting in portrait or landscape orientation. Set includes two double-ended dry-erase markers in assorted colors, full-size magnetic eraser with two bullet-tip markers, six colorful magnets, and an 2.7oz bottle of board cleaner.

Must purchase in case pack quantities of 1  
0.625" Thick

**ELR-0488** 24" x 36" Magnetic Dry-Erase Set **\$55**



## STACK & STORE TUB

Great for storing art supplies and other loose items at school or at home! Bins fit most standard cubby units to keep belongings organized and accessible. Available with or without matching lids. Heavy-duty plastic with rounded edges for safety.

Must order in case pack quantities as listed below

Colors: Blue (BL), Red (RD), Yellow (YE), Clear (CL), Assorted (AS) includes Blue, Red and Yellow  
8.5"W x 13.5"D x 5"H

<b>ELR-0101-XX</b>	Stack & Store Tub without Lid	case pack of 15	<b>\$7</b>
<b>ELR-0102-XX</b>	Stack & Store Tub with Lid	case pack of 12	<b>\$9</b>
<b>ELR-20505-AS</b>	15pk Stack & Store Tub without Lid	case pack of 1	<b>\$108</b>
<b>ELR-20506-AS</b>	12pk Stack & Store Tub with Lid	case pack of 1	<b>\$108</b>

## SCOOP FRONT BINS

Scoop Front Bins are perfect for storing toys, games, art supplies, and more! Rounded edges are safe and easy for little hands to hold and carry. Brightly colored bins fit both Birch and Colorful Essentials storage units. Made of heavy-duty plastic.

Must order in case pack quantities of 10

Colors: Blue (BL), Clear (CL), Green (GN), Red (RD), Sand (SD), White (WH), Yellow (YE)  
8"W x 11.8"D x 5.3"H

**ELR-0482-XX \$5**



## STORAGE BINS AND LIDS

Sturdy, versatile bins are great for storage and organization! Red, blue, or clear bins are designed for use with Birch and Colorful Essentials classroom storage units. Available with or without lids.

Must order in case pack quantities of 20.

Colors: Blue - (BL), Red - (RD), or Clear-(CL)  
Small Bin: 10.25"W x 13.75"D x 4.25"H  
Large Bin: 10.25"W x 13.75"D x 8.25"H

<b>ELR-0722-XX</b>	Large Storage Bin without Lid	<b>\$10</b>
<b>ELR-0723-XX</b>	Large Storage Bin with Lid	<b>\$12</b>
<b>ELR-0724-XX</b>	Small Storage Bin without Lid	<b>\$8</b>
<b>ELR-0725-XX</b>	Small Storage Bin with Lid	<b>\$10</b>

## TRAYS & LIDS

Brightly colored trays in fun shapes and sizes are perfect for playrooms or classrooms! Versatile and convenient storage bins keep toys and games at hand with safe, easy-to-carry rounded edges. Available with or without clear lids.

Must order in case pack quantities of 20

Colors: Blue (BL), Red (RD), or Yellow (YE)  
Square and Quarter Tray: 15"W x 15"D x 6.9"H  
Fan Tray: 22"W x 16"D x 6.9"H

<b>ELR-0800-XX</b>	Square Tray without Lid	<b>\$16</b>
<b>ELR-0801-XX</b>	Square Tray with Lid	<b>\$18</b>
<b>ELR-0802-XX</b>	Quarter Circle Shaped Tray without Lid	<b>\$16</b>
<b>ELR-0803-XX</b>	Quarter Circle Shaped Tray with Lid	<b>\$18</b>
<b>ELR-0804-XX</b>	Fan Shaped Tray without Lid	<b>\$16</b>
<b>ELR-0805-XX</b>	Fan Shaped Tray with Lid	<b>\$18</b>





### 3 COMPARTMENT SMALL ART CADDY

Small Art Caddy is perfect for storing or transporting art materials. Three compartments (two small and one large) hold paintbrushes, crayons, watercolors and more. Made of durable plastic that is easy to clean. Includes one each: blue, red, yellow, and green.

*Must order in case pack quantities of 3*

9.25"W x 9.25"D x 5.25"H

**ELR-0467** 4 Pc Small Caddy **\$20**

### 2 COMPARTMENT LARGE ART CADDY

Large Art Caddy has plenty of room for paints, brushes, crayons, and anything else young artists might need for their masterpieces! Two large compartments keep supplies organized. Handles on top of the unit allow children to carry it easily from storage to their workspace. Made of durable plastic that is easy to wipe clean. Includes one of each: blue, green, red and yellow.

*Must order in case pack quantities of 3*

12.5"W x 11"D x 6.75"H

**ELR-0454** 4 Pc Large Caddy **\$36**

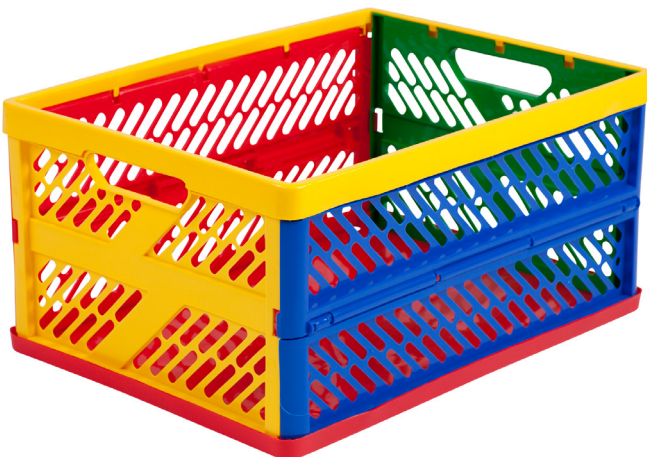

### COLLAPSIBLE CRATE

Keep art supplies, toys, projects and more organized in the multi-colored collapsible crate. The bright unit features built-in handles for easy transport and locks open for safety and durability. Folds flat for easy storage! Crates stack both open and closed.

*Must order in case pack quantities of 12*

**ELR-0170** 19"W x 13.75"D x 9.5"H **\$18**

### 27 PIECE SMALL PAINT CRATE SET

Paint the town red...or blue, or purple, or yellow! Young artists will love bringing their imagination to life with a rainbow of bright colors and assorted brushes. A colorful, collapsible crate keeps supplies organized and on hand. Set includes crate, seven 8oz. bottles of washable paint in assorted colors, seven bilingual, non-spill paint cups with hinged, flip-top lids, seven paint brushes, three foam rollers.

*Must order in case pack quantities of 1*

**ELR-0207** 19"W x 13.75"D x 9.5"H **\$160**





## SOLID HARDWOOD UNIT BLOCK SETS

Imaginations come alive when these blocks come out to play! Solid hardwood blocks bring creativity and fun into the classroom or the living room. As children build kingdoms and roadways and really, really tall towers, they will develop reasoning skills, motor skills—even math skills! Smooth, hand-sanded blocks have beveled edges and rounded corners for safety, and are all based on a uniform 1.25" width for easy building. Refer to the block chart on the ECR4Kids website for what shapes are included in each set.

*Must order in case pack quantities of 1*  
*Basic Unit Block: 5.50"W x 2.75"D x 1.25"H*

<b>ELR-19001</b>	64 Pc Hardwood Unit Block Set w/Carry Case	<b>\$70</b>
<b>ELR-078</b>	75 Pc Hardwood Unit Block Set	<b>\$180</b>
<b>ELR-079</b>	118 Pc Hardwood Unit Block Set	<b>\$300</b>
<b>ELR-19000</b>	154 Pc Hardwood Unit Block Set	<b>\$330</b>
<b>ELR-080</b>	170 Pc Hardwood Unit Block Set	<b>\$420</b>
<b>ELR-081</b>	340 Pc Hardwood Unit Block Set	<b>\$840</b>



## 48 PC ARCHITECTURAL BLOCK SET WITH CARRY CASE

Frank Lloyd Wright had to start somewhere... your little architects will dream big with these blocks designed especially to build houses, skyscrapers, and more! The set includes 11 different shapes to create your very own architectural masterpiece. Solid hardwood, hand-sanded blocks come with a handy carrying case that also doubles as a sturdy building platform.

*Must order in case pack quantities of 1*  
*14.75" W, 12.25"D x 3.75"H*

**ELR-19003 \$70**



## 18 PC WOODEN HOLLOW BLOCK SET

Big blocks for big ideas! Little ones will love building ramps and cities with these over-sized blocks. Set includes a variety of shapes and sizes, and blocks have rounded edges for added safety.

*Must order in case pack quantities of 1*  
*Basic Unit: 7.8"W x 3.9"D x 3.9"H*

**ELR-0342 \$200**



*Actual colors may vary.*

## WOODEN TUNNELS & ARCHES

For kids who think outside the box! These curved blocks are perfect for building tunnels, bridges, or the Loch Ness monster. Set of birch blocks comes with four different widths. The 10 piece set includes four small, two medium, two large, two extra-large arches. Quantities are doubled for 20 Piece Set.

*Must order in case pack quantities of 1*  
*X-Large- 11"Diameter, Large- 5.5"Diameter, Medium- 3.75"Diameter, Small- 2.20"Diameter; .4"H*

<b>ELR-19101</b>	10 Piece Set	<b>\$65</b>
<b>ELR-0333</b>	20 Piece Set	<b>\$110</b>



## TRANSPORTATION VEHICLES

Beep, beep—coming through! When there's a lot of work to do around town, solid hardwood Transportation Vehicles will get the job done. Big Rig, Fire Truck, Flatbed Truck, and Bus each come with two wooden people to drive through the city. Vehicles and people feature smooth, sanded, solid wood construction with beveled edges and rounded corners for added safety. Designed for use with the ECR4Kids block collection, blocks not included.

*Must order in case pack quantities of 1*



<b>ELR-19102</b>	Big Rig	27"W x 7"D x 11.5"H	<b>\$120</b>
<b>ELR-19103</b>	Fire Truck	23"W x 6.5"D x 9.5"H	<b>\$120</b>
<b>ELR-19104</b>	Flatbed Truck	27"W x 8"D x 9"H	<b>\$100</b>
<b>ELR-19105</b>	Single-Decker Bus	23"W x 6.5"D x 9"H	<b>\$115</b>
<b>ELR-19106</b>	Set of Four Transportation Vehicles		<b>\$450</b>
<b>ELR-19107</b>	6 Pc Hardwood People	1.25" Diameter x 2.75"H	<b>\$16</b>

## WOODEN UNIT BLOCK CART

Keep blocks organized and easily accessible in our hardwood block storage cart. Cart is made of solid wood and has rounded corners for safety. Built-in handles on each side and four casters for easy mobility. Blocks sold separately. 

*Must order in case pack quantities of 1*



**ELR-0341**     21.50"W x 21.50"D x 16.50"H     **\$140**

## CASTERS

Four casters included for mobility.



## BLOCK STORAGE CARTS

Perfect for keeping block sets of any size organized! Multiple cubbies keep blocks easily accessible, and make clean-up a snap when play time is over. Available in three different sizes to accommodate small to large block sets. Designed specifically for use with ECR4Kids blocks  

*Must order in case pack quantities of 1*

<b>ELR-17200</b>	Small	24"W x 13"D x 24" H	<b>\$160</b>
<b>ELR-17201</b>	Medium	36"W x 13"D x 24"H	<b>\$210</b>
<b>ELR-17202</b>	Large	48"W x 13"D x 24"H	<b>\$250</b>





# SoftZone®

## COVER

Phthalate-Free Vinyl

## FOAM CORE

Soft, Sturdy, Polyurethane

## EASY TO CLEAN

Wipe clean with mild soap and water solution

## ROUNDED EDGES

For Added Safety

## CALIFORNIA TB117 STANDARDS

Fire retardancy

## CPSIA COMPLIANT

## GREENGUARD CERTIFIED

## ADULT ASSEMBLY AND SUPERVISION REQUIRED



Select Units feature our unique SoftZone® pattern. Look for this symbol.

Actual colors may vary.

## YOUTH SEATING SET (PICTURED ABOVE)

Create a comfortable learning environment or play room. The bright set is ideal for kids to rest, read, and do activities, both alone and as a group.

Must order in case pack quantities of 1

Yellow Table: 24"W x 24"D x 12"H

Blue Love Seat: 36"W x 18"D x 24"H

Red Chair: 24"W x 18"D x 24"H

<b>ELR-12648</b>	2 Pack Youth Chair	<b>\$250</b>
<b>ELR-12649</b>	4 Piece Youth Seating Set	<b>\$650</b>

## CARRY ME CUBE

A comfortable and fun alternative to sitting on the floor! The brightly colored cubes come in your size choice of child or adult. Carry the lightweight cubes using the attached handle.

<b>ELR-12645</b>	Child	12"W x 12"D x 9.5"H	Set of 4	<b>\$130</b>
<b>ELR-12646</b>	Adult	16"W x 16"D x 12"H	Single	<b>\$95</b>





## SOFTZONE® SEATING



### 8 PIECE SECTIONAL

Create a center of attention for any learning environment or play room with this comfy softscape sectional. With bright and comfortable seats in an island design, it is ideal for toddlers to rest, read, and do activities, both alone and as a group! All eight separate pieces easily attach to create one large sectional or separate to create your own configuration.

**ELR-0838** 65"W x 38"D x 20"H **\$580**

### CARRY ME CUSHION

These cushions come in your choice of brightly colored squares or circles. Great for story time, snack time, or just to relax. Cushions feature a 3" durable and soft foam core. Carry the lightweight cushions using the attached handles.

Each pack includes 4 of each color: Blue (BL), Green (GN), Red (RD), Yellow (YE) and Assorted (AS) 15"W x 15"D x 3"H

**ELR-12643-XX** Round Case pack of 4 **\$85**  
**ELR-12644-XX** Square Case pack of 4 **\$85**



### CARRY ME CHAISE LOUNGE

Children will love to stretch out on the brightly colored chaise lounge. Perfect for relaxing or reading a story. Carry the chaise using the attached handle. Folds up for easy storage.

Case pack quantity of 1

**ELR-12647** 34"W x 15"D x 14"H Case pack of 2 **\$250**

### SIT AND SUPPORT RING

Encourage your little one to sit up tall. The bright and colorful ring provides 6" of comfort and support allowing little ones to feel independent. For use on the floor only.

Must order in case pack quantities of 1

**ELR-12627** 24"W x 18"D x 6"H **\$85**



### STEP UP

Reach new heights with the step stool made from high-density foam with an extra-wide platform for safety and stability. The lightweight stool is easy to move from room to room.

Must order in case pack quantities of 1

**ELR-12651** 24"W x 16"D x 12"H **\$110**

**NEW!**



GROSS MOTOR PLAY



**NEW** ROLEY POLEY SOFTZONE

Practice balance on the new Roley Poley SoftZone. Children will love going from block to block either crawling or walking. Designed specifically for use on the floor to ensure a safe and fun playtime. When playtime is over, role up the Roley Poley for convenient storage. New item available in March 2015.

**ELR-12636** 48"W x 8"D x 8"H **\$130**

SPEED BUMP CLIMBER

Up, down and all around! Little ones can climb up and down the ECR4Kids Soft-Zone® Speed Bump Climber. This beginner climber is perfect for exploring and imagining. Encourage climbing, crawling, and social interaction and develop gross motor skills.

**ELR-12633** 36"W x 24"D x 12"H **\$160**



SIT & PLAY RAINBOW CATERPILLAR

Who wants a ride on the giant rainbow caterpillar? I do, I do! Cheerful caterpillar invites little ones to climb aboard for playtime. Multiple brightly colored rainbow blocks are soft and sturdy, with room for two or more children. Caterpillar can be turned on its side for added stability. Designed specifically for use on the floor to ensure a safe and fun playtime.

**ELR-12630** Large 48"W x 8"D x 8"H **\$120**  
**ELR-12650** Small 36"W x 6"D x 6"H **\$80**

BARRELS OF FUN

Two children at once can enjoy Barrels of Fun! Encourage safe play with the brightly colored soft barrel and cylinder. Children will love to crawl through the cylinder, climb on the barrel or simply roll around for fun! The cylinder fits inside the barrel perfectly for convenient storage.

Must order in case pack quantities of 1

**ELR-12634** 22"W x 22"D x 24"H **\$260**



SENSORY EXPLORATION



PADDED MIRRORS

Lookin' good! Padded mirrors are perfect for developing facial recognition and motor skills, and for making funny faces together. Brightly colored padding provides a soft, cheerful frame for silly smiles and goofy grins.

**ELR-12665** Flat 34"W x 34"D x 2.2"H **\$150**  
**ELR-12666** Bubble Outie 34"W x 34"D x 3.4"H **\$225**  
**ELR-12667** Bubble Innie 34"W x 34"D x 3.4"H **\$250**  
**ELR-12668** 3 Pack of of Padded Mirrors **\$575**

Actual colors may vary.

**DISCOVERY CENTER WITH TUNNEL AND SLIDE** 

Crawl through the tunnel and see how much there is to discover! Little ones will love pulling themselves up to find bells, mirrors and loops as they move around the discovery circle. Climb up and slide down when playtime is over. Stimulating center has padded floor and soft edges for safe and comfortable play. 

Must order in case pack quantities of 1

**ELR-12637** 76"W x 56"D x 16"H **\$615**



**DISCOVERY CIRCLE** 

This ring provides a safe and stimulating environment with bells, shapes, and pockets to hide things! Practice pulling up on the circles' soft edges. When playtime is over, fold up the Discovery Circle and store.

Must order in case pack quantities of 1

**ELR-12638** 36"W x 36"D x 8"H **\$300**

**DISCOVERY PLAY CUBE** 

Peek-a-boo, I see you! As they crawl through the brightly colored play cube, little ones will find bells, shapes, and mirrors along the way. Encourage motor skills and practice peek-a-boo through the cutout window. Padded floor for comfort and safety.

Must order in case pack quantities of 1

**ELR-12626** 36"W x 24"D x 24"H **\$330**



**PICTURE ME PLAY MAT** 

Little ones will love tummy time on this rainbow play mat! Circular mat features a mirror in the center for making funny faces, and six clear 4" x 6" pockets to hold photos or images of your choice.

Must order in case pack quantities of 1

**ELR-12629** 36"W x 36"D x 1" **\$110**

**PULL UP MIRROR** 

Little ones can be a star and watch themselves on their own television shaped mirror with crushable corners for safety. Perfect for pulling up and self-esteem. Excellent for developing infant/toddler image cognition, speech therapy or just making funny faces!

Must order in case pack quantities of 1

**ELR-0862** 17.5"W x 16"D x 18"H **\$100**



**WHEEL OF MIRRORS** 

Little ones will find this pentagon full of mirrors fascinating and stimulating! Fold it up and move it around or unfold it for added fun with the mirrors. Kids will build fine motor skills, learn about their own faces and the expressions they make all while having a blast.

Must order in case pack quantities of 1

**ELR-0860** 12"W x 59.5"D x 8.5"H **\$160**

360° CLIMBERS



TUNNEL MAZES

Over and under, in and out—which way will you go? ! Kids will be captivated by all the fun choices of shapes, colors and paths with ECR4Kids tunnel mazes. Tunnels are constructed of higher-density foam to keep children safe while they explore. Tunnel Mazes encourage climbing, crawling, social interaction and help develop gross motor skills.

Must order in case pack quantities of 1

<b>ELR-0837</b>	Tunnel Maze	95"W x 95"D x 18"H	<b>\$1,200</b>
<b>NEW ELR-12652</b>	Single Tunnel Maze	70"W x 64"D x 18"H	<b>\$450</b>
<b>ELR-12656</b>	Triple Tunnel Maze	64"W x 64"D x 18"H	<b>\$600</b>



ELR-12652

WHEEL SOFTZONE

The perfect learningscape for little ones! Designed with crawlers and new walkers in mind, the 19 piece unit is only 12 inches high to encourage the youngest children to explore up and down safely. The SoftZone® Wheel comes complete with steps, slides, speed bumps, and safety mats. Separate loop-lock attachments allow different configurations to customize for each unique space.

Must order in case pack quantities of 1

<b>ELR-0836</b>	87"W x 87"D x 12"H	<b>\$1,400</b>
-----------------	--------------------	----------------



RAINBOW PETAL CLIMBER WITH BALL POOL

A rainbow petal climber perfect for beginners with a ball pool for added adventure! Children will love to climb on one of the six brightly colored petals set at different heights. The climber's center is a ball pool with attached vinyl flooring, filled with an assortment of brightly colored, long-lasting, polyethylene balls.

Don't have space for the petals? This item is also available as the ball pool only!

Must order in case pack quantities of 1

<b>ELR-12624</b>	Rainbow Petal Climber with Ball Pool	58.5"W x 64"D x 12"H	<b>\$700</b>
<b>NEW ELR-12670</b>	Mini Nest Ball Pool	36"Diameter x 12"H	<b>\$320</b>
<b>ELR-12602</b>	SoftZone PE Balls - 120 Pc		<b>\$30</b>



ELR-12624

RAINBOW PETAL CLIMBER

Safe for multiple users, children will love to climb on one of the seven primary colored platforms set at different heights. Encourage climbing, crawling, and social interaction and help develop gross motor skills.

Must order in case pack quantities of 1

<b>ELR-12625</b>	58.5"W x 64"D x 12"H	<b>\$560</b>
------------------	----------------------	--------------



TRI-LEVEL CLIMBER

A beginner climber with bright, primary colors and shapes to create a center of attention for any space! The three levels allow children to climb to the top of this comfy and stimulating learning environment.

Must order in case pack quantities of 1

<b>ELR-12616</b>	44.25"W x 44.25"D x 15"H	<b>\$550</b>
------------------	--------------------------	--------------

Actual colors may vary.



**ROUNABOUT**

Climb, crawl, slide, step, roll, balance, sit and jump—the Roundabout climber has it all! Kids will gain confidence and gross motor skills as they move around the circle to explore different surfaces and fun obstacles. 15 foam bolsters in different shapes provide endless hours of safe play.

*Must order in case pack quantities of 1*

**ELR-12606** 79"W x 74"D x 10"H **\$900**

**RAINBOW CLIMBER**

Up, up, and away! Little ones will soar to new heights at each brightly colored platform on their way to the top. Made up of five primary brightly colored platforms set at different heights, the climber will help develop gross motor skills as they explore.

*Must order in case pack quantities of 1*

**ELR-12615** 54"W x 54"D x 15"H **\$510**

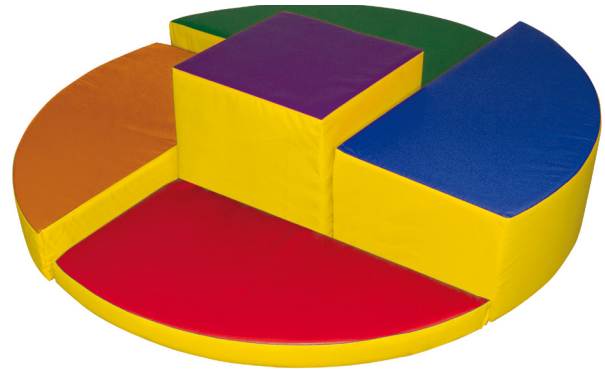

**LINCOLN TUNNEL CLIMBER**

Toddlers will be captivated by the fun tunnel and cozy corners in this unique climber. Tunnel has higher-density foam to keep kids safe while they're exploring! Climb the stairs featuring a toddler footprint fabric and go down the soft slide on the other side. Multiple children can play at once on this softscape.

*Must order in case pack quantities of 1*

**ELR-12612** 59.25"W x 59.25"D x 15"H **\$500**



**RAINBOW SOFTZONE®**

Over the rainbow we go! The Rainbow SoftZone® set encourages toddlers to safely climb, crawl and balance in a soft, stable environment. The seven foam bolsters set at different heights hook to the rainbow arches with loop lock attachments to prevent pieces from sliding apart during use. 1" thick green bumper pads sold separately add an extra level of safety to this exciting climber.

*Must order in case pack quantities of 1*

**ELR-0835** Rainbow SoftZone® 74"W x 37"D x 18.5"H **\$1,000**  
**ELR-0864** Green Bumper Pad 64"W x 16"D x 1"H **\$100**



45



**FUN FOR TWO**

Crawl up the side stairs or go down the uniquely patterned slide on the Fun For Two! This beginner climber is perfect for two children to explore at once! Cozy corners provide the perfect place to relax with a cushioned back.

*Must order in case pack quantities of 1*

**ELR-12617** 61.5"W x 63"D x 12"H **\$500**

### SLIDE AND CRAWL SET

Slide, crawl and play! Kids will be encouraged to climb, explore and learn as they play on this colorful six piece set. Tunnels have higher-density foam to keep kids safe while they're exploring. Encourage climbing, crawling, social interaction and assist in the development of gross motor skills. 

Must order in case pack quantities of 1

**ELR-12607** 70"W x 70"D x 20"H **\$500**



## WALL CLIMBERS

Designed specifically for use against a wall to ensure a safe and fun playtime – not intended for free-standing use.



### PEAKS & PASSAGES

Future mountain climbers rejoice! A more challenging climber for older pre-schoolers. Children will get to explore hidden passages and visit far away lands as they climb and crawl their way around new peaks and passages. Tunnels have higher-density foam to keep kids safe while they're exploring! 

Must order in case pack quantities of 1

**ELR-12611** 79.25"W x 60"D x 31.75"H **\$1,025**

### LITTLE ME CLIMB AND SLIDE

Watch me, watch me! Little ones will gain confidence and have fun as they learn to climb and slide on this brightly colored beginning climber. 

Must order in case pack quantities of 1

**ELR-12653** Little Me Climb and Slide 40"W x 20"D x 10"H **\$160**  
**ELR-12654** Little Me Wall Climb and Slide 60"W x 40"D x 10"H **\$410**



### HIGH RISE CLIMBER

A challenge for even the most experienced climbers! Children have the opportunity to grow and explore under and around the exciting spiral stair case and tunnel combination. 

Must order in case pack quantities of 1

**ELR-12608** 63"W x 63"D x 28"H **\$800**



## CORNER CLIMBERS

Designed specifically for use in a corner to ensure safe and fun playtime – not intended for free-standing use.



### CORNER TUNNEL MAZE

A beginner climber with bright shapes, colors and paths that creates a center of attention for any space! Tunnels have higher-density foam to keep kids safe while they're exploring.

Must order in case pack quantities of 1

**ELR-12655** 60"W x 60"D x 18"H **\$600**

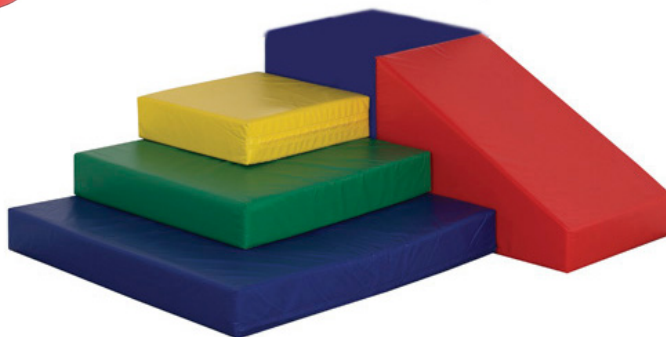

### CLIMB AND SLIDE

What goes up must come down—little ones will love climbing up and sliding down on sturdy, brightly colored foam platforms. Perfect for crawlers and climbers to build motor skills and have lots of fun!

Must order in case pack quantities of 1

**ELR-12610** 68"W x 57"D x 24"H **\$900**



### ROLLING HILLS CORNER CLIMBER

Little climbers will have fun and develop social skills as they help each other up and over brightly colored hills. Encourage movement and build confidence as they climb, roll, and slide.

Must order in case pack quantities of 1

**ELR-12609** 60"W x 60"D x 15"H **\$600**

### PRIMARY CORNER CLIMBERS

Brightly colored corner pieces are perfect for sliding and climbing. A variety of angles and surfaces are a fun place for little ones to build motor skills and use their imagination!

Must order in case pack quantities of 1

**ELR-0834** Primary Corner Climber 59"W x 56"D x 18"H **\$760**  
**ELR-0833** Primary Climber with Ball Pool 60"W x 60"D x 18"H **\$720**



47



### LITTLE ME CORNER

Up, down and all around! Slide, climb or relax in on this cozy climber.

Must order in case pack quantities of 1

**ELR-12618** 39.5"W x 39.5"D x 10"H **\$295**

**NEW MINI SPIRAL MOUNTAIN** 

A beginner climber with a spiral staircase, platform for relaxing, and a slide. 

Must order in case pack quantities of 1

**ELR-12669** 60"W x 60"D x 18"H **\$270**



**NEW!**



**WATCH ME GO CLIMBER** 

Up, down and all around! Slide, climb or relax on this cozy climber made of six brightly colored pieces. 

Must order in case pack quantities of 1

**ELR-12614** 48" x 45" x 16" **\$600**

**FUNCTIONAL DEVELOPMENT**

**JUMBO SOFT BLOCKS** 

Designed for young architects, engineers and builders! Little ones can build up, out and all around with these lightweight jumbo blocks. Encourages social interaction, imagination and invention as well as gross and fine motor skills.

Must order in case pack quantities of 1

Block Size Range: 12.0" x 12.0" x 6.0" to 17.0" x 12.0" x 34.0"

**ELR-12603** 14 Piece Jumbo Soft Blocks **\$675**  
**ELR-12604** 21 Piece Jumbo Soft Blocks **\$900**  
**ELR-12605** 35 Piece Jumbo Soft Blocks **\$1,500**



48



**DRESS ME UP AND LEARN** 

Shoe-laces, buckles, and zippers, oh my! Dress Me Up and Learn will help teach little ones skills to last a lifetime while they are having fun at playtime. Vinyl covered foam base features zippers, lacing, buttons, bow ties, hook & loop, and chrome closures that are excellent for developing fine motor skills.

Must order in case pack quantities of 1

**ELR-0863** Cube 16.5"W x 16.5"D x 16.5"H **\$235**  
**ELR-0858** Panel 16.5"W x 3.5"D x 16.5"H **\$75**  
**ELR-12628** Pentagon 19"W x 18"D x 11.5"H **\$130**



## PATCHWORK TODDLER MAT AND BLOCKS

Keep playtime safe and stimulating for even the youngest children. Toddler blocks are just the right size for tiny hands! Teach manual manipulation and color recognition by encouraging children to match the blocks to the colors in the mat.

Must order in case pack quantities of 1

<b>ELR-031</b>	Patchwork Toddler Mat	58"W x 58"D x 1.5"H	<b>\$155</b>
<b>ELR-033</b>	Soft Toddler Blocks	5.5"W x 5.5"D x 5.5"H	<b>\$100</b>
<b>ELR-0215</b>	Patchwork Mat and Blocks		<b>\$250</b>



## 7 PIECE BIG BLOCKS

Imagine being able to build with blocks your own size. With ECR4Kids SoftZone® Big Blocks, that's precisely what your kids can do! Seven big, bright and chunky blocks in three different shapes and sizes stimulate children's creativity and stacking skills. Playing with blocks is a treasured pastime that helps develop gross motor skills in children.

Must order in case pack quantities of 1

4pcs - 8.0" x 8.0" x 8.0", 2pcs - 16.0" x 8.0" x 8.0", 1pc - 16.0" x 16.0" x 8.0"

<b>ELR-0832</b>	7 Piece Big Blocks	<b>\$175</b>
-----------------	--------------------	--------------

## TUMBLING MATS



### CONVENIENT HANDLES

Handles included for mobility.



## TUMBLING MATS

Children will enjoy active play on the brightly colored, multi-panel tumbling mats from ECR4Kids. Perfect for doing forward rolls and cartwheels with adult supervision or gathering for story time; a necessity for any preschool, daycare or home.

Each tumbling mat is made up of four sections, each highlighted in one of four bright, primary colors. The entire mat is constructed of 2" thick polyurethane dense foam to maximize resiliency and durability. Color and stability make for the ideal mat for a multitude of settings. Tumbling mats easily attach to one another to extend the fun across the room. Use the convenient hook and loop extensions to connect mat to mat and keep the tumbling at a maximum.

When it's time to pack up the fun, your job is a breeze. Mats clean up with a quick soap and water wipe down. They fold in half and are easily carried away to storage using the sewn-in handles.

All Mats: 2" H

<b>ELR-0651</b>	4'W x 4'D x 2"H	<b>\$150</b>
<b>ELR-028</b>	4'W x 6'D x 2"H	<b>\$200</b>
<b>ELR-0649</b>	4'W x 8'D x 2"H	<b>\$230</b>





# Active Play

## EASY TO CLEAN

Heavy-Duty Plastic

## ROUNDED EDGES

For Added Safety

## FADE AND WEATHER RESISTANT

Indoor or Outdoor Use

## CPSIA COMPLIANT

## GREENGUARD CERTIFIED

## ADULT ASSEMBLY REQUIRED

Hardware Included for Easy Assembly

## COUNTRY ESTATE

The large ECR4Kids Country Estate playhouse is the ideal place for multiple children to play at once. The playhouse features a mail slot, working door and windows and a picnic bench for added fun. Walls feature bright colors and intricate details including a stone facade, address inscription, pretend entryway lighting, plants, animals and more. The estate is easy to assemble and great for indoor or outdoor use. 

*Must order in case pack quantities of 1*

**ELR-12518** 63.50"W x 78.75"D x 67.75"H **\$800**



*Actual colors may vary.*

©2015 ECR4KIDS



ELR-12501  
\*Tail not included

ELR-035

“GUS” CLIMB-N-CRAWL CATERPILLAR – 4-SECTION

Climb in, on, or around “Gus” the Climb-N-Crawl Caterpillar from ECR4Kids! Children will have so much fun discovering this charismatic caterpillar climber specially designed for use indoors or out. Featuring four brightly colored body segments, a happy face and tail, this climber can be assembled in numerous configurations to entice preschoolers to climb, crawl and interact. Large boot-shaped “feet” hold the unit firmly in place for safety and stability.

An extension set is available to add on to Gus! Four different colorful sections allow this caterpillar to extend from four units to eight body segments. Gus Extension Set does not include a face or tail; not for use as a standalone item.

Must order in case pack quantities of 1



- ELR-035
- ELR-12501
- NEW ELR-SPC-15423

4 Section “GUS”	39.50”W x 42.50”W x 85.50”D	<b>\$379</b>
4 Section “GUS” Extension Set	39.50”W x 70”D x 20.50”H	<b>\$320</b>
“GUS” and Extension Set	39.50”W x TBD	<b>\$660</b>

VIBRANT “GUS” CLIMB-N-CRAWL CATERPILLAR

A daycare favorite is now available in vibrant blue, green, pink and orange! Designed exactly the same as traditional Gus, each body segment is speckled with holes for children to peer into and out of during playtime. Configure and re-configure sections in various order to keep the look fresh, new and cheerful all around.

Must order in case pack quantities of 1

NEW ELR-12520 20.50”W x 85.50”D x 39.50”H **\$379**



PEEK-A-BOO CATERPILLAR

Climb in, on, or around the Peek-A-Boo Caterpillar! A smaller version of “Gus” for the little ones. Children will enjoy counting the caterpillars brightly colored feet and discover a variety of lively colors. Preschoolers will be enticed to climb up onto the Peek-A-Boo Caterpillar and hug its head and neck, or crawl through the sunlit tunnel. They can perch on top to sing songs with friends or listen to a story; what a neat place to gather. The Peek-A-Boo Caterpillar is great for active preschoolers to stretch their legs and imaginations!

Must order in case pack quantities of 1

ELR-12511 56.25”W x 37”D x 47.75”H **\$320**



**TREE TOP CLIMB AND SLIDE** 

Active children will love the ECR4Kids' Tree Top Climb and Slide! The fun climber features apple trees on both sides, so kids will feel like they are really in a tree. Two side ladders make it easy to access the platform, reach the tree tops and wavy slide. Take a break from climbing and sliding on the sturdy bench with a backrest, conveniently located in the back of the tree house. The multipurpose table reverses to become a sand pit. The possibilities are truly endless! Parents will love the easy to clean multipurpose tree house. 

*Must order in case pack quantities of 1*

**ELR-12510** 78.75"W x 49"D x 54.75"H **\$550**



**BUCCANEER BOAT** 

Ahoy matey! Imaginations will soar when kids jump aboard the Buccaneer Boat from ECR4Kids. This brightly colored boat has everything you need to begin your nautical adventure including a pirate flag and moveable wheel. With the captain on the deck and crew in the cabin, this Buccaneer Boat will create a realistic experience for any imaginative child. Constructed using blow molded plastic; the boat can be used indoors or outdoors to encourage active play and socialization. No more than one child at a time should be at the helm of the ship. 

*Must order in case pack quantities of 1*

**ELR-12508** 54"W x 31"D x 57"H **\$250**



**CLIMB AND SLIDE** 

Children can climb, hide, crawl and slide on and around the Climb and Slide from ECR4Kids. The straight slide reverses and becomes a set of stairs that leads to a platform. Children can climb through the back door and up to the platform using the stability bar above. 

*Must order in case pack quantities of 1*

**ELR-12503** 66"W x 33"D x 40"H **\$340**



**LAKE COTTAGE** 

Designed for use indoors or out, the ECR4Kids Lake Cottage will have kids playing make believe in no time. The cottage comes complete with a porch, charming columns and working windows and door. Intricate details adorn the cottage walls including a picket fence, bricks and your children's favorite animal friends. 

*Must order in case pack quantities of 1*

**ELR-12512** 66" x 41.5" x 46.5" **\$420**



*Actual colors may vary.*



**NEW!**



**JUMBO 4-TO-SCORE** 

**ELR-12521**

Kids of all ages love this oversized version of the classic game! Guaranteed to be a hit with family and friends at birthday parties, family reunions, community centers, after-school programs, and more. Young players build teamwork and cooperation skills while they learn to match four to win. This interactive game is great for 2 players, and also works with teams for epic kids-vs-grown-ups championship matches. Fade and weather resistant. 

*Must order in case pack quantities of 1*

<b>ELR-12507</b>	Jumbo 4-To-Score	48"W x 22.5"D x 46"H	<b>\$300</b>
<b>NEW ELR-12521</b>	Jumbo 4-To-Score - Vibrant	48"W x 24"D x 34.5"H	<b>\$300</b>

**JUNIOR 4-TO-SCORE** 

ECR4Kids Junior 4-To-Score is perfect for turning play time into learning time. The game encourages cooperation and teamwork, as well as problem solving and basic matching skills. Players of all ages will gain social skills while interacting one-on-one or in teams, and kids can play again and again as they discover endless patterns and possibilities. Ideal for use in classrooms and after-school programs. Fade and weather resistant. 

*Must order in case pack quantities of 1*

**ELR-12509** 46.25"W x 23.6"D x 34.5"H **\$230**



Accessories			
<b>Primary colors only, not available in vibrant colors.</b>			
<b>ELR-23201</b>	Jumbo 4-To-Score 20 Pc Replacement Rings		<b>\$60</b>
<b>ELR-23202</b>	Junior 4-To-Score 20 Pc Replacement Rings		<b>\$60</b>



**PHANTY PIC-N-ROCK** 

The ECR4Kids Phanty Pic-N-Rock is a great way to keep kids entertained for play time and lunch time. One side is a picnic table and the other side is a rocker. Phanty can accommodate up to four children at a time. This table and rocker literally snaps together, no tools required. Quick and easy assembly means playtime can start even sooner! 

*Must order in case pack quantities of 1*

**ELR-040** 27.2"W x 45.5"D x 22"H **\$240**



Active Play



ELR-12401

## SAND & WATER TABLES

Promote tactile discovery, fine motor skills, and social interaction with the ECR4Kids Sand & Water Tables. Each station features brightly colored basins that are removable for easy draining and cleaning. Translucent lids are included to keep sand, water and toys securely in the unit when not in use. Stations feature strong steel legs that adjust to three heights: 20", 22.5" and 26." Connect a variety of ECR4Kids Sand & Water Tables to make your own unique configuration. 

ECR4Kids Sand & Water Tables should not be left outside, metal legs can rust.

Must order in case pack quantities of 1

<b>ELR-12401</b>	2 Station Square Sand & Water Play Table with Lids	14.75"W x 30"D	<b>\$140</b>
<b>ELR-0798</b>	4 Station Round Sand & Water Play Table with Lids	30"W x 30"D	<b>\$240</b>
<b>ELR-0799</b>	4 Station Square Sand & Water Play Table with Lids	30"W x 30"D	<b>\$240</b>
<b>ELR-0796</b>	6 Station Sand & Water Play Table with Lids	49.5"W x 49.5"D	<b>\$320</b>
<b>ELR-0797</b>	8 Station Sand & Water Play Table with Lids	60"W x 30D	<b>\$400</b>
<b>ELR-0795</b>	10 Station Sand & Water Play Table with Lids	75"W x 45"D	<b>\$560</b>



ELR-0798



ELR-0799



ELR-0796



ELR-0797



ELR-0795



### 3-IN-1 ART EASEL

The ECR4Kids 3-in-1 Art Easel has everything your child needs to create their very own masterpiece. Made of durable hardwood, the easel features a magnetic dry-erase board on one side and a chalkboard on the other. On top, the roll of paper can be pulled down and secured with magnets to paint and draw. The convenient storage tray is the perfect place to keep the included accessories: three paint cups, multi-color chalk, dry-erase marker, six magnets and erasers. When finished, the easel folds up for storage.

The easel adjusts to accommodate children of all heights. Simply unscrew the star detailing and slide the easel to the desired height using the alignment guides. Screw the stars back in and you are ready to draw. 

Must order in case pack quantities of 1

**ELR-17401** 23"W x 19.5"D x 36"H **\$79**

### ART EASELS WITH STORAGE

Keep art supplies organized and ready to go whenever inspiration strikes. Double-sided birch hardwood easel has plenty of room for little ones to paint and draw together. Each station has a dry-erase board, trays for paint cups, easel clips, and additional storage below. Bins not included. 

Must order in case pack quantities of 1

**ELR-0691** 2 Station 27"W x 26.50"D x 46.50"H **\$300**  
**ELR-0692** 4 Station 53"W x 26.50"D x 46.50"H **\$450**



**ELR-0692**

### ADJUSTABLE EASEL AND ART SUPPLIES

Children can explore their creative side with the ECR4Kids double-sided adjustable art easel featuring a chalkboard on one side and dry-erase board on the other. The easel includes two paint trays to help keep children organized and four red easel clips to hold artwork in place. Great in the home or for school use, the easel is heavy-duty with solid hardwood legs. Legs are adjustable for three different heights including 18", 20" and 22.5" from the floor to the bottom edge of the board. 

Paint the town red... or blue, or purple, or yellow! Young artists will love bringing their imagination to life with a rainbow of bright colors and assorted brushes. A colorful, collapsible crate keeps supplies organized and on hand. Set includes crate, seven 8oz. bottles of washable paint in assorted colors, seven bilingual, non-spill paint cups with hinged, flip-top lids, seven paint brushes, three foam brushes, and two foam rollers. Paint is washable from most clothing, but may stain porous household items.

ELR-0330 includes the Paint Crate Set and Adjustable Easel.

Must order in case pack quantities of 1

Art surfaces: 24"W x 24"H

Paint Colors: Black, Blue, Green, Purple, Red, White, & Yellow

**ELR-008** Double-Sided Adjustable Easel 25.25"W x 25"D x 47"H **\$140**  
**ELR-0207** Small Paint Crate Set 13.75"W x 9.50"D x 6.75"H **\$55**  
**ELR-0330** Easel with Small Paint Crate Set 24"W x 48"H **\$160**



**ELR-008**



(855) ECR-4KIDS  
 (855) 327-4543

## CRAFT TAPE DISPENSER WITH 10 PC TAPE ROLL

A rainbow of creativity at your fingertips! Perfect for scrapbooking, art projects, and more. The set includes hardwood tape dispenser with safe plastic cutting edge, and 10 rolls of Craft Tape in assorted colors. Dispenser holds up to 12 1" rolls of tape, so you will have extra room to keep standard masking tape on hand.

Stock up on your favorite craft tape colors. A 10-pack of Craft Tape rolls in your choice of 10 brilliant colors. Specify color. ELR-0352 assorted 10-pack includes: black, white, blue, green, orange, pink, purple, red, turquoise, and yellow. Replacement rolls available in single colors or assorted packs.

13.5"W x 6"D x 6.25"H; Each Roll: 1"W x 60yds



ELR-0359

<b>ELR-0359</b>	Craft Tape Dispenser with 10 Piece Assorted Tape Roll	Case pack of 1	<b>\$75</b>
<b>ELR-0163</b>	Craft Tape Dispenser Only	Case pack of 1	<b>\$32</b>
<b>ELR-0351-XX</b>	Solid Pack Colored Masking Tape Roll	Case pack of 120	<b>\$4</b>
<b>ELR-0352</b>	Assorted Pack Colored Masking Tape	Case pack of 12	<b>\$40</b>



ELR-0239

## KRAFT EDGERS®

Create beautiful borders and unique designs for scrapbooks, photos, invitations, and more! Kraft Edgers® are easy to use and perfect for art projects at home or in the classroom. Patterns include: Pinking, Wave, Scallop, Lace, Victorian, Bubbles, Bounces, Cloud, Dragon Back, Mini-Scallop, Zipper, and Sunflower. The ECR4Kids Kraft Edgers offer endless design possibilities for scrapbooking, art, or photo projects. Edgers are available packed in a hanging vinyl storage pouch with look and lock closure, or a 18 piece hardwood rack. Styles may vary and are subject to change without notice. Ages 4+.

Must order ELR-0129 in case pack quantities of 6

<b>ELR-0129</b>	Kraft Edgers® Classpack with Storage Pouch, 12 pc set	<b>\$16</b>
<b>ELR-0239</b>	Kraft Edgers® Caddy, 18 pc with hardwood rack	<b>\$40</b>

## TEACHER STAMPS

Recognize a job well done or request a parent's signature. The ECR4Kids 8 Piece Teacher Stamp Set includes the phrases "Way To Go", "Super Star" or "Parent Signature." The stamps are great for grading homework, to use in the classroom, or for art projects. Each stamp makes 30,000+ impressions and features a matching cap to keep the ink fresh and help prevent drying out. Stamps are acid and lignin free.

Must order in case pack quantities of 12

Tray: 2.25"W x 2.75"D x 8"H; Stamp: 2"W x .875"D x 2.5"H

<b>ELR-0349</b>	8 pc Teacher Stamps - Set 1	<b>\$20</b>
<b>ELR-0361</b>	8 pc Teacher Stamps - Set 2	<b>\$20</b>



## HARDWOOD UTILITY CART

Art supplies stay organized and easily accessible on this hardwood utility cart. Perfect for storing paints, bottles, brushes, and more! Hardwood unit has three easy-to-clean shelves, with two handles and four casters for easy mobility (two locking casters). Accessories not included. [Twitter](#) [Facebook](#)

Must order in case pack quantities of 1

<b>ELR-076</b>	34.50"W x 21.25"D x 32.50"H	<b>\$280</b>
----------------	-----------------------------	--------------

Actual colors may vary.



## HORIZONTAL CHANGING STATION

The ECR4Kids Horizontal Changing Station provides a comfortable place to change baby! Designed specifically for use in a commercial environment including schools, restaurants, and business environments. The changing station features two convenient hooks for diaper bags, purses and more as well as a safety strap and pneumatic cylinder to provide a controlled, slow opening and closing of the changing station. A qualified professional should install the Horizontal Changing Station, hardware not included. The desired installation location and wall type will dictate the required mounting hardware.

Purchase the Horizontal Changing Station and Changing Pads together to save!

*Must order in case pack quantities of 1*

*Open: 35.5"W x 19"D x 19"H*

*Closed: 35.5"W x 4"D x 19"H*

- ELR-18004**    Horizontal Changing Station                    **\$230**
- ELR-18009**    Horizontal Changing Station with 500 Pads    **\$280**

Accessories		
	<b>ELR-003</b> 2-Ply Changing Pads <i>19"W x 13"D, Case pack of 500</i>	<b>\$60</b>



Infant and Toddler

## BABY CHANGER

The space saving Baby Changer from ECR4Kids is a must for any new parent. Constructed of ultra-soft vinyl, this pad features gently sloping sides which cradle your baby during the changing process providing both comfort and safety. The best part is there is no assembly required!

*Must order in case pack quantities of 1*

- ELR-029**    28"W x 18"D x 5.5"H                    **\$50**



## DOUBLE-SIDED BI-DIRECTIONAL MIRROR

Who's that? Little ones will love making faces at that baby in the mirror during tummy-time! Double-sided, birch hardwood framed safety mirror. Removeable feet allow the mirror orientation to be changed from vertical to horizontal making this mirror attractive to both young and older children alike. 

*Must order in case pack quantities of 1*

- ELR-0701**    14.50"W x 16"D x 48"H                    **\$145**

# Bits and Pieces

We understand accidents can happen. And when they do, we've got you covered. Keep in mind that we may offer additional parts not listed here. Give us a call if you have any questions.

- ELR-23102-XX**    20 Pcs Replacement Boots – Large                    **\$20**
- ELR-23103-XX**    20 Pcs Replacement Boots – Small                    **\$20**
- ELR-17303**        Hooks for Lockers -10 Pk                                **\$20**
- ELR-23104**        Kiddie Cot Corners - 12 Pk                              **\$25**
- ELR-12602**        SoftZone PE Balls - 120 Pc                             **\$30**

# BE THE FIRST TO REVIEW!

We've added ratings and reviews to [www.ecr4kids.com](http://www.ecr4kids.com) and we're telling you first!



At ECR4Kids, we are committed to developing and distributing the highest quality classroom furniture and equipment. Customer satisfaction and feedback is very important to us. We want customers to write about their products while they are still fresh in their mind. Their input will help others make more informed decisions.

Below is just a sampling of some of the product reviews we have received so far!

58



#### We Love "GUS"!!

*Our 1 year old daughter LOVES this tunnel. She's scared of most of the tunnels that are fully enclosed so this one is unique because she can see in and out of it and use it also as a play area inside or a "fort." The colors are attractive and although a bit large, fits perfectly in our backyard. Lots of kids can play at once in, on and around it. I highly recommend! - SuperMom*

#### Great Chairs & Price

*We've had these chairs for several months now, we are so happy with them. They are sturdy, easy to clean, and perfect for our students to use/move around. I highly recommend these chairs for classroom or home setting - Happy*



#### Would Buy Again

*This was super easy to assembly, I'm a woman with no technical skills, and is more sturdy and reliable than I expected for the price. I would definitely recommend this for durability and quality. - Elfin*

#### Great Organizer

*After looking at different options to organize our toys, I decided on this product. We just received it today, and it was so simple to put together. We are now dividing different categories of toys into the different bins. I was worried the bins might be too small, but they seem to fit a lot.. The 4 large bins are nice for bigger blocks. The bins seem sturdy. My only negative is that I wish lids were included.. All in all, I'm pleased with my purchase. - Miri*



Actual colors may vary.

©2015 ECR4KIDS

**Product Color** For product colors please refer to an ECR4Kids product PMS color sheet. Due to printing and computer monitor limitations, we cannot be held liable for variations in color. If color must be precise, please consult a PMS chart or request a random sample of the product color.

## ADJUSTABLE ACTIVITY TABLES: TABLE TOP

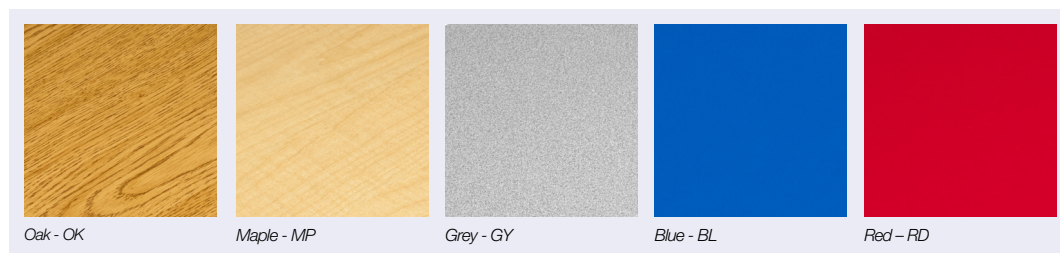

## ADJUSTABLE ACTIVITY TABLES: EDGE BANDING

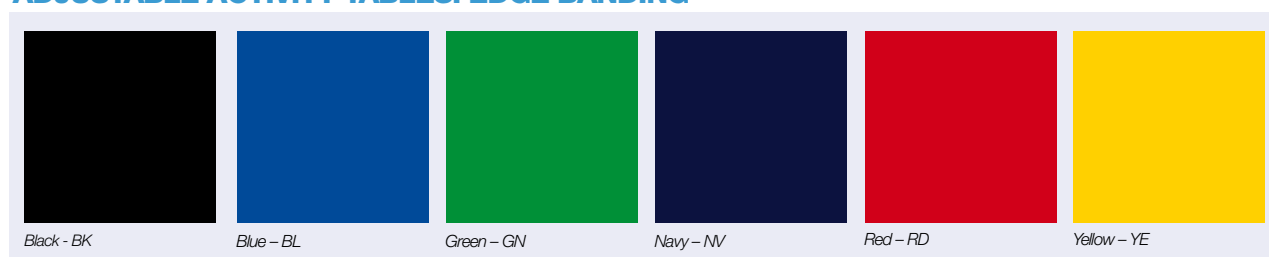

## SCHOOL STACK CHAIRS



## RESIN TABLES AND CHAIRS

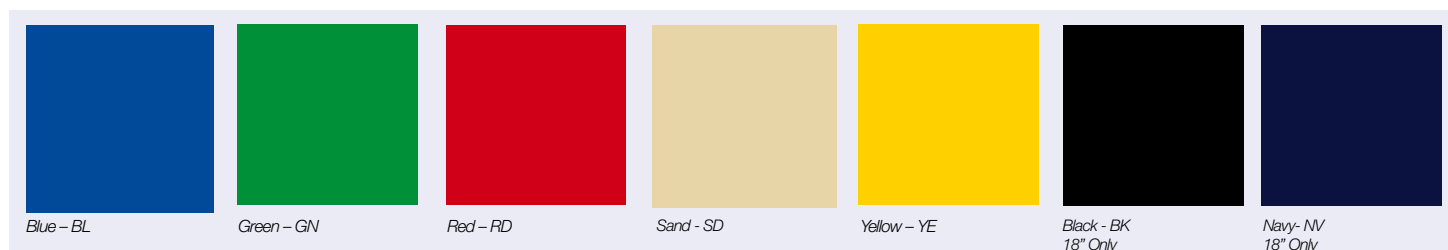

\*Actual colors may vary.

## WE STAND BEHIND OUR PRODUCTS

ECR4Kids stands behind the quality of all of our products. For extended warranty information, please visit our website at [www.ecr4kids.com](http://www.ecr4kids.com).

## SAFETY IS OUR #1 PRIORITY

Total lead, lead in surface coating, phthalates and toy safety are just some of the standards that the CPSC has set forth in the Consumer Product Safety Improvement Act of 2008. ECR4Kids continues to meet and exceed these standards to ensure that our customers can be confident in the safety of our products. Any inquiries on testing and safety standards should be directed to the ECR4Kids Compliance Department at [compliance@ecr4kids.com](mailto:compliance@ecr4kids.com)

## ECR4KIDS CATALOG—GENERAL INFORMATION & PRINTING/PRODUCT DISCLAIMERS

The 2015 ECR4Kids catalog provides general information about products manufactured and/or offered by ECR4Kids and does not constitute a contract. ECR4Kids reserves the right without prior notice to: change, delete, supplement or otherwise amend at any time the information, images, and specifications contained in this catalog or other documents. Information contained in this catalog is not necessarily complete. For further information please consult with an ECR4Kids Sales Representative via email at [sales@ecr4kids.com](mailto:sales@ecr4kids.com) or telephone (855) ECR-4KIDS.

- **Pricing**

All prices listed in this catalog are Manufacturer's Suggested Retail Price (MSRP). In some cases, the MSRP represents the actual (or approximate) market selling price. In other situations, due to industry standards, the MSRP may be significantly higher than actual market conditions would dictate. In all cases, the MSRP is provided merely as a reference/convenience.

Although our stated policy is to maintain consistent pricing throughout the calendar year, we reserve the right to make price adjustments for all products and offers due to changing manufacturing/availability (as a result of product discontinuation, raw material price changes, currency fluctuations, etc.), freight and/or fuel surcharges, errors in advertisements and other extenuating circumstances.

Volume pricing is available. Contact your Sales Representative for additional information and terms.

- **Product Color**

For product colors please refer to an ECR4Kids product PMS color sheet. Due to printing and computer monitor limitations, we cannot be held liable for variations in color. If color must be precise, please consult a PMS chart or request a random sample of the product color.

- **Scuffs & Scratches (Plastic)**

It is the nature of plastic to scuff and scratch when stacked and shipped. Clear and darker colored plastics show this the most. These scuffs and scratches are not considered a defect.

- **Trademarks**

All artwork used in this catalog and provided to ECR4Kids Dealers, must be utilized in full compliance with all applicable laws regarding trademark, licensing, copyright, right of privacy, patent or similar protection.

- **Accessories**

Unless described as included with the product being offered, accessories shown in photos are not included.

- **Availability**

All items offered in this catalog are subject to availability.

ITEM NUMBER	PAGE	ITEM NUMBER	PAGE	ITEM NUMBER	PAGE	ITEM NUMBER	PAGE	ITEM NUMBER	PAGE	ITEM NUMBER	PAGE
ELR-003	57	ELR-0482-XX	36	ELR-0750-XX	31	ELR-12645	40	ELR-15410-XX	15	ELR-19003	38
ELR-008	55	ELR-0488	35	ELR-076	56	ELR-12646	40	ELR-15412-XX	15	ELR-19101	38
ELR-009-XX	34	ELR-0501	26	ELR-078	38	ELR-12647	41	ELR-15414-XX	15	ELR-19102	39
ELR-010-5	32	ELR-0547	34	ELR-079	38	ELR-12648	40	ELR-15416-XX	15	ELR-19103	39
ELR-0101-XX	36	ELR-0547B	34	ELR-0795	54	ELR-12649	40	ELR-15418-XX	15	ELR-19104	39
ELR-0102-XX	36	ELR-0549	34	ELR-0796	54	ELR-12650	42	ELR-15501	25	ELR-19105	39
ELR-011-XX	34	ELR-0549B	34	ELR-0797	54	ELR-12651	41	ELR-16111-XX	32	ELR-19106	39
ELR-0129	56	ELR-0573-XX	33	ELR-0798	54	ELR-12652	44	ELR-16112-XX	32	ELR-19107	39
ELR-0163	56	ELR-0574	33	ELR-0799	54	ELR-12653	46	ELR-16113	32	ELR-20101-XX	34
ELR-0167	35	ELR-0575	33	ELR-080	38	ELR-12654	46	ELR-16114	32	ELR-20102-XX	34
ELR-0170	37	ELR-0576	33	ELR-0800-XX	36	ELR-12655	47	ELR-16117	32	ELR-20103-XX	34
ELR-0192-XX	9	ELR-060	14	ELR-0801-XX	36	ELR-12656	44	ELR-16118	32	ELR-20104-XX	34
ELR-0193-XX	9	ELR-061	14	ELR-0802-XX	36	ELR-12655	42	ELR-16119	32	ELR-20401	35
ELR-0194-XX	9	ELR-063	14	ELR-0803-XX	36	ELR-12666	42	ELR-16120	32	ELR-20505-AS	36
ELR-0195-XX	9	ELR-064	14	ELR-0804-XX	36	ELR-12667	42	ELR-16121	32	ELR-20506-AS	36
ELR-0207	37,55	ELR-0644-NT	12	ELR-0805-XX	36	ELR-12668	42	ELR-16122	32	ELR-2192-XX	9
ELR-0215	49	ELR-0645-NT	12	ELR-081	38	ELR-12669	48	ELR-16123	32	ELR-2193-XX	9
ELR-0216	35	ELR-0646-NT	12	ELR-083	24	ELR-12670	44	ELR-16124	32	ELR-2194-XX	9
ELR-023	32	ELR-0647-NT	12	ELR-0832	49	ELR-14101-XX	6	ELR-16125-AS	32	ELR-2195-XX	9
ELR-0231-5	32	ELR-0649	49	ELR-0833	47	ELR-14102-XX	6	ELR-16126-AS	32	ELR-22101	14
ELR-0234	32	ELR-065	14	ELR-0834	47	ELR-14103-XX	6	ELR-16127-AS	32	ELR-23102-XX	12,57
ELR-0239	56	ELR-0651	49	ELR-0835	45	ELR-14104-XX	6	ELR-16128-AS	32	ELR-23103-XX	12,57
ELR-024	32	ELR-066	14	ELR-0836	44	ELR-14106-XX	6	ELR-16129-AS	32	ELR-23104	57
ELR-026	32	ELR-0660-NT	12	ELR-0837	44	ELR-14107-XX	6	ELR-16200	25	ELR-23201	53
ELR-0261-XX	34	ELR-0668	33	ELR-0838	41	ELR-14108-XX	6	ELR-16202	33	ELR-23202	53
ELR-028	49	ELR-067	14	ELR-0858	48	ELR-14109-XX	6	ELR-17100	24	ELR-24101	17
ELR-029	55	ELR-068	14	ELR-0860	43	ELR-14110-XX	6	ELR-17101	24	ELR-24102	17
ELR-031	49	ELR-0680	26	ELR-0862	43	ELR-14111-XX	6	ELR-17102	24	ELR-SPC-15405	25
ELR-033	49	ELR-0681	26	ELR-0863	48	ELR-14112-XX	6	ELR-17103	23	ELR-SPC-15423	51
ELR-0330	55	ELR-0682	26	ELR-0864	45	ELR-14113-XX	6	ELR-17104	23	ELR-SPC-16301	32
ELR-0333	38,55	ELR-0683	26	ELR-12401	54	ELR-14114-XX	6	ELR-17108	23	ELR-SPC-16302	32
ELR-0335	24	ELR-0684	26	ELR-12501	51	ELR-14115-XX	6	ELR-17109	23	ELR-SPC-22201	19
ELR-0339	24	ELR-069	14	ELR-12503	52	ELR-14116-XX	6	ELR-17200	39		
ELR-0341	39	ELR-0690	24	ELR-12507	53	ELR-14117-XX	6	ELR-17201	39		
ELR-0342	38	ELR-0691	55	ELR-12508	52	ELR-14118-XX	6	ELR-17202	39		
ELR-0344	25	ELR-0692	55	ELR-12509	53	ELR-14119-XX	6	ELR-17206	21		
ELR-0345	25	ELR-0693	27	ELR-12510	52	ELR-14120-XX	6	ELR-17207	21		
ELR-0349	56	ELR-0695	27	ELR-12511	51	ELR-14121-XX	6	ELR-17208	21		
ELR-035	51	ELR-0696	22	ELR-12512	52	ELR-14124-XX	6	ELR-17209	20		
ELR-0351-XX	56	ELR-0697	22	ELR-12518	50	ELR-14125-XX	6	ELR-17209-XX	20		
ELR-0352	56	ELR-0698	22	ELR-12520	51	ELR-14126-XX	6	ELR-17215	20		
ELR-0359	56	ELR-0699	22	ELR-12521	53	ELR-14301-XX	13	ELR-17215-XX	20		
ELR-0361	56	ELR-070	14	ELR-12602	44,57	ELR-14302-XX	13	ELR-17216	20		
ELR-0368	25	ELR-0700	27	ELR-12603	48	ELR-14303-XX	13	ELR-17216-XX	20		
ELR-040	53	ELR-0701	27,57	ELR-12604	48	ELR-14405-XX	15	ELR-17217	20		
ELR-0419	21	ELR-0702	27	ELR-12605	48	ELR-14406-XX	15	ELR-17217-XX	20		
ELR-0420	21	ELR-071	14	ELR-12606	45	ELR-14407-XX	15	ELR-17218	20		
ELR-0421	21	ELR-0711-XX	29	ELR-12607	46	ELR-15102	9	ELR-17218-XX	20		
ELR-0422	21	ELR-0712-XX	29	ELR-12608	46	ELR-15104-XX	9	ELR-17252	20		
ELR-0423	21	ELR-0713-XX	29	ELR-12609	47	ELR-15107-AS	9	ELR-17252-XX	20		
ELR-0424	21	ELR-0714-XX	29	ELR-12610	47	ELR-15108-AS	9	ELR-17230	19		
ELR-0425	19	ELR-0715-XX	29	ELR-12611	46	ELR-15110-AS	9	ELR-17231	19		
ELR-0426	20	ELR-0716-XX	29	ELR-12612	45	ELR-15111-AS	9	ELR-17232	19		
ELR-0426-XX	20	ELR-0717-XX	30	ELR-12614	48	ELR-15112-AS	9	ELR-17233	19		
ELR-0427	20	ELR-0718-XX	30	ELR-12615	45	ELR-15120-AS	9	ELR-17253	21		
ELR-0427-XX	20	ELR-0719-XX	30	ELR-12616	44	ELR-15134-AS	15	ELR-17300	19		
ELR-0428	20	ELR-072	14	ELR-12617	45	ELR-15135-AS	15	ELR-17301	19		
ELR-0428-AS	20	ELR-0720-XX	29	ELR-12618	47	ELR-15136-AS	15	ELR-17303	57		
ELR-0428-CL	20	ELR-0721-XX	29	ELR-12624	44	ELR-15137-AS	15	ELR-17304	19		
ELR-0428-SD	20	ELR-0722-XX	36	ELR-12625	44	ELR-15140-AS	9	ELR-17305	19		
ELR-0429	23	ELR-0723-XX	36	ELR-12626	43	ELR-15141-AS	9	ELR-17401	55		
ELR-0430	26	ELR-0724-XX	36	ELR-12627	41	ELR-15301-NT	13	ELR-17500	25		
ELR-0431	26	ELR-0725-XX	36	ELR-12628	48	ELR-15301-XX	13	ELR-17504-XX	31		
ELR-0432	26	ELR-0726-XX	29	ELR-12629	43	ELR-15302-NT	13	ELR-17505-XX	31		
ELR-0433	26	ELR-0727-XX	30	ELR-12630	42	ELR-15302-XX	13	ELR-17506	25		
ELR-0434	26	ELR-0728-XX	30	ELR-12633	42	ELR-15316	14	ELR-18004	57		
ELR-0450	22	ELR-0744-XX	31	ELR-12634	42	ELR-15318	14	ELR-18005	14		
ELR-0451	22	ELR-0745-XX	31	ELR-12636	42	ELR-15320	14	ELR-18006	14		
ELR-0452	25	ELR-0746-XX	31	ELR-12637	43	ELR-15322	14	ELR-18007	14		
ELR-0453	19	ELR-0747-XX	31	ELR-12638	43	ELR-15324	14	ELR-18009	57		
ELR-0454	37	ELR-0748-XX	31	ELR-12643	41	ELR-15326	13	ELR-19000	38		
ELR-0467	37	ELR-0749-XX	31	ELR-12644	41	ELR-15327	23	ELR-19001	38		

## WHAT OUR CUSTOMERS ARE SAYING!

“Just wanted to let you know I bought the big soft play blocks as well as the multicolored mat with soft blocks. My two youngest boys 3 yrs and 18 months have autism. For Christmas we focused on sensory play and that led me to your products. I work in product development and I know that it is rare to be told by a customer what you are doing right so I wanted to make a point to email you. My boys love your items so much. They pile the blocks and jump off the ottoman onto the mat throughout the day. They are so happy. My 18 month old is non verbal and because of your blocks and me repeating “ready, set, go” before he crashes into them, he said his first word “go” yesterday. For us autism parents what may be minor to most is huge to us and your blocks helped bridge a connection I longed for daily. Thank you for making wonderful products. We are working our way up to buy more as we work on a sensory room for our boys since they love to climb I see a soft climber in our near future. Thank you so very much for making wonderful products that bring me even closer to my children and help them progress.

—Kelly, ECR4Kids Customer



855-ECR-4KIDS  
(855) 327-4543  
[www.ecr4kids.com](http://www.ecr4kids.com)  
[ecrcs@ecr4kids.com](mailto:ecrcs@ecr4kids.com)