



INNOVATION, PERFORMANCE AND COMMITMENT SINCE 1953

A central image shows a wooden clipboard with a silver clip at the top, holding a white sheet of paper. A black whistle is attached to the left side of the clipboard. The paper contains a handwritten-style quote in blue ink. Surrounding the clipboard are various sports items: a white soccer ball with black panels to the left, a red and white American football in the foreground, a white baseball with red stitching in the foreground, and a large orange basketball to the right. The background is a textured, light-colored wall with blue and green watercolor-like splatters.

*"Set your goals high,
and don't stop
till you get there."*

- Bo Jackson

2015

ALL SPORTS



TAKE THIS CATALOG WITH YOU



The NOVA World Cup Anchor is the ideal style for your Soccer program. All surface friendly, long lasting and will fit any goal! page 31



Jaypro has the solution for leaning or rusted systems, our Hoop Rejuvenator Kits will save time, effort and money! pages 74-75



Stop chasing the ball on those missed shots, check out our Portable Field Netting and other "FieldPro" Field Netting Systems. pages 97-99



We ensure High Quality Sports Equipment for Years of Use!

DESIGN

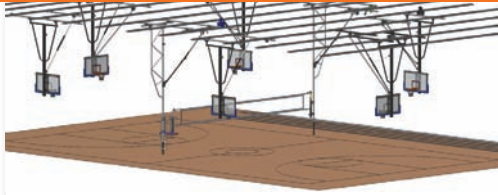

ENGINEERING



MANUFACTURING



At Jaypro Sports, we make it easy for Facility Planners to design sports equipment into their Facility with our new Architect and Specification Center located at www.JayproSpecs.com.

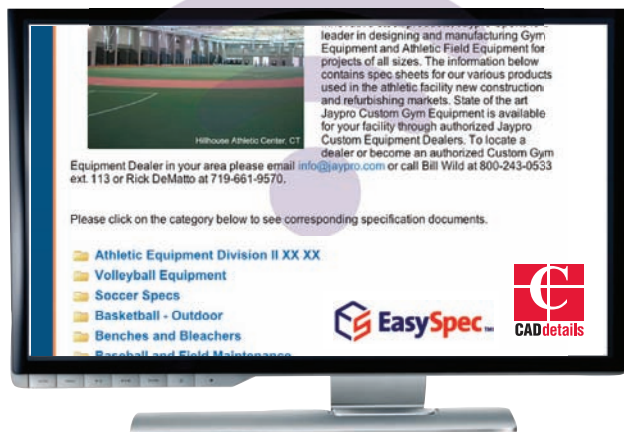

Don't see what you're looking for in our catalog? Or need information on custom products? Contact Jaypro Customer Service at 800-243-0533.

	FEATURED PRODUCTS 2-3
	<i>New and Innovative products featuring Team Pink</i>
	Volleyball 4-17
	<i>Indoor & Outdoor Systems, Floor Sleeves, Nets, Referee Stands & Training Equipment</i>
	Soccer 18-37
	<i>Goals, Indoor/Outdoor, Youth, Nets, Rebounders, Anchors, Post Pads & Combo Goals</i>
	Football 38-44
	<i>Goal Posts, Post Pads, Shoulder Pad & Helmet Carts, Training Aids, Field & Turf Accessories</i>
	Field Hockey/Lacrosse 45-47
	<i>Official Goals, Practice Goals, Folding Goals and Nets</i>
	Baseball 48-66
	<i>Batting Cages, Pitching Screens, Field Mats & Covers, Bases, Mounds, Drags & Foul Poles</i>
	Field Marking 67-69
	<i>Dry, Wet & Combo Markers, Line Layout & Marking Systems</i>
	Scoreboards & Sports Training . . . 70-71
	<i>Scoreboards & Sports Training Machines</i>
	Basketball 72-83
	<i>Outdoor Units, Hoop Rejuvenator, Padding, Backboards, Goals & Edge Padding</i>
	Indoor Gymnasium 84-95
	<i>Portables, Wall Mounted Backstops, Safety Strap, Winches, Height Adjusters, Curtains & Wall Pads</i>
	Outdoor Field 96-99
	<i>Ultimate Athletic Field & Field Netting</i>
	Benches and Bleachers 100-107
	<i>Bleachers, Scorers Table & Players Benches</i>
	Ball Storage 108-111
	<i>Ball Carriers & Carts</i>
	P.E., Recreation 112-117
	<i>P.E. Equipment, Backboard Adapter, Game Standards & Tetherball</i>
	Tennis, Index and Terms 118-120
	<i>Posts, Nets, & Tennis Bench, Index, Terms & Conditions</i>



NEW

VOLLEYBALL SOCCER FOOTBALL LACROSSE BASEBALL FIELD MARKING SCOREBOARD BASKETBALL GYMNASIUM FIELD SEATING BALL STORAGE PHYS. ED. TENNIS



Football Helmet Storage Cart;
PAGE 42



World Cup Anchor Cart; PAGE 31



Soccer Net Clips;
PAGE 32



Football Kicking Cage; PAGE 44



Field ID Numbers;
PAGES 33 & 47



Wide-Body Ball Carts;
PAGE 110



Mini Top Roll Curtain; PAGE 85



Scoreboards; PAGE 70

Sports Attack Training;
PAGE 71



FieldPro Discus Cage; PAGE 99



Volleyball Court Line;
PAGE 17



Jaypro's Team Pink Program



Jaypro Sports is proud to introduce the Team Pink Program which will help support the Terri Brodeur Breast Cancer Foundation. A portion of the proceeds from sales will benefit the TBBCF. This Foundation is a, 501 (c) (3) non-profit organization and is dedicated to fighting this devastating disease. This Foundation is different from other breast cancer foundations in that **100%** of the gross fundraising dollars goes directly to breast cancer research. Please visit www.tbbcf.org for more information or to donate to this very worthy cause!



Upright Pads, PAGES 13 & 14
Net Tape, PAGE 11



LadyPro Carbon
PAGE 8

Dress up your Volleyball System with our Pink Upright Pads and the Team Pink Net Tape. Purchase the LadyPro Carbon Volleyball System and a portion will be donated to the Terri Brodeur Breast Cancer Foundation.



Sit in comfort on these
bright Plank Pads PAGE 104



Powdercoat PINK
any Bench or
Bleacher PAGES 100-107



Football Post
Pads in Pink
PAGE 41



Add a little
"Pink" to your
Soccer Goal
with sand bags
and net clips
PAGES 31-32



Show your
Spirit with a
new and
exciting Edge
Pad color
PAGE 81

NEW VOLLEYBALL SOCCER FOOTBALL LACROSSE BASEBALL FIELD MARKING SCOREBOARD BASKETBALL GYMNASIUM FIELD SEATING BALL STORAGE PHYS. ED. TENNIS

Jaypro has taken the guesswork out of ordering additional accessories for our best selling systems.

Choose the package that fits your programs needs and save!

FREE LETTERING
on
Upright Padding
System
Packages
(PVL-39)

Deluxe Featherlite Package Shown (PVB-5PKGDX)

PATENTED FLEX NET

Don't have a Jaypro system but want the benefits of the Flex Net?

No Problem...

The Flex Net will adapt to most existing system uprights!



Spend Time Setting Up Your Shot, Not Your Net!

- ✓ Quick Set-Up
- ✓ Easy to Use
- ✓ Superb Net Tension
- ✓ No Extra Cables or Straps

See Page 10 for details...

All Recreational and Multi-Purpose Game Standards can be found in the Physical Education section on pages 112-115!





Standard Powerlite System Package

Package includes:

Powerlite International Net System
 (PVB-7000 or PVB-6500, page 6)
 Folding Referee Stand (VRS-6000) and Padding
 (VRS-60P, page 14)
 Single Net Keeper (VNK11, page 11)
 Hammock Drill Cart (HSVBC24, page 15)
 Cable/Buckle Covers (VCC-12, page 13)
Plus... FREE LETTERING on Upright Padding, a \$318 value!!!

PVB-7PKG 3-1/2" **\$4,239 package**
 (price if purchased separately \$5,104)

PVB-6PKG 3" **\$4,339 package**
 (price if purchased separately \$5,204)

A SAVINGS OF \$865

Deluxe Powerlite System Package

Package includes:

Powerlite International Net System
 (PVB-7000 or PVB-6500, page 6)
 Folding Referee Stand (VRS-6000) and Padding (VRS-60P, page 14)
 Single Net Keeper (VNK11, page 11)
 Hammock Drill Cart (HSVBC24, page 15)
 Cable/Buckle Covers (VCC-12, page 13)
 Volleyball Equipment Carrier (EC-500, page 15)
 The Spiker (TS612, page 16)
Plus... FREE LETTERING on Upright Padding, a \$318 value!!!

PVB-7PKGDX 3-1/2" **\$4,739 package**
 (price if purchased separately \$5,672)

PVB-6PKGDX 3" **\$4,839 package**
 (price if purchased separately \$5,772)

A SAVINGS OF \$933

Standard Featherlite System Package

Package includes:

Featherlite Collegiate Net System
 (PVB-5000 or PVB-4500, page 7)
 Folding Referee Stand (VRS-6000) and Padding
 (VRS-60P, page 14)
 Single Net Keeper (VNK11, page 11)
 Hammock Drill Cart (HSVBC24, page 15)
 Cable/Buckle Covers (VCC-12, page 13)
Plus... FREE LETTERING on Upright Padding, a \$318 value!!!

PVB-5PKG 3-1/2" **\$3,599 package**
 (price if purchased separately \$4,344)

PVB-4PKG 3" **\$3,699 package**
 (price if purchased separately \$4,444)

A SAVINGS OF \$745

Deluxe Featherlite System Package

Package includes:

Featherlite Collegiate Net System
 (PVB-5000 or PVB-4500, page 7)
 Folding Referee Stand (VRS-6000) and Padding (VRS-60P, page 14)
 Single Net Keeper (VNK11, page 11)
 Hammock Drill Cart (HSVBC24, page 15)
 Cable/Buckle Covers (VCC-12, page 13)
 Volleyball Equipment Carrier (EC-500, page 15)
 The Spiker (TS612, page 16)
Plus... FREE LETTERING on Upright Padding, a \$318 value!!!

PVB-5PKGDX 3-1/2" **\$4,069 package**
 (price if purchased separately \$4,912)

PVB-4PKGDX 3" **\$4,169 package**
 (price if purchased separately \$5,012)

A SAVINGS OF \$843

#1 Selling Volleyball with our Pate

Industry Best Infinite Height Adjustment

Powerlite International Net System for 3-1/2"

Simply the best world class volleyball net system available today! Designed for International, Collegiate and Advanced High School Level. Lightweight aluminum uprights with Infinite Height Adjustment range from 6' 6" to 8' 2". Uprights are designed to fit 3-1/2" diameter sleeves. Look on page 12 for measuring instructions. All competition systems meet NCAA, NFHS and USVBA specifications and come with a **10 Year Limited Warranty on the uprights**. **Center package includes:** center pole with winch, patented Flex net and upright padding, which can be purchased in addition to these systems for a two-court set-up!

PVB-7000	Complete System	116 lbs.	\$3,389
PVB-70U	Upright Only (includes winch)	82 lbs.	\$2,469
PVBC-700	Center Package	62 lbs.	\$2,369

Powerlite International Net System for 3"

Same as the PVB-7000 system except the uprights have a factory installed adapter. Uprights are designed to fit 3" diameter sleeves.

PVB-6500	Complete System	117 lbs.	\$3,489
PVB-65U	Upright Only (includes winch)	83 lbs.	\$2,569
PVBC-650	Center Package	63 lbs.	\$2,469

48 HOUR
QUICK SHIP



System Features:



Patented Flex Net



Recessed Polymer
Pulley Wheel



Worm Drive Winch



Powder Coated
Tough Finish

System in America Patented Flex Net!



Industry Best Pin Stop Height Adjustment

Featherlite Collegiate Net System for 3-1/2"

The most affordable, high performance, all aluminum net system available today! Designed for Collegiate and High School Level. Lightweight aluminum uprights with 16 Pin Stop Height Adjustment range from 6' 6" to 8' 2". Uprights are designed to fit 3-1/2" diameter sleeves. Look on page 12 for measuring instructions. **Center package includes:** center pole with winch, patented Flex net and upright padding, which can be purchased in addition to these systems for a two-court set-up!

Best Seller!

48 HOURS QUICK SHIP

PVB-5000	Complete System	104 lbs.	\$2,629
PVB-51U	Upright Only (includes winch)	70 lbs.	\$1,759
PVBC-500	Center Package	60 lbs.	\$1,659



Featherlite Collegiate Net System for 3"

Same as the PVB-5000 system except the uprights have a factory installed adapter. Uprights are designed to fit 3" diameter sleeves.

PVB-4500	Complete System	105 lbs.	\$2,729
PVB-45U	Upright Only (includes winch)	71 lbs.	\$1,859
PVBC-450	Center Package	56 lbs.	\$1,759



Complete System Includes:



Uprights with Worm Drive Winch



Patented Flex Net
See page 10



Upright Padding
See page 13 for pad color



Antennae
See page 11

Floor Sleeve Info, see page 12



PVB-70S

Folding Referee Stand Info, see page 14



VRS-6000



PVB-8000

LadyPro Carbon Women's Volleyball System Carbon Ultralite Telescoping Volleyball System

Jaypro's new top of the line, carbon volleyball systems include the only all carbon uprights on the market. Fabricated from state-of-the-art carbon composite material, specially wound to offer the rigidity of steel yet significantly lighter in weight than aluminum. Available in 3" or 3-1/2" diameter and fixed women's height of 7'-4-1/8" or our new telescoping option with a height adjustment range from intramurals to mens competition. **Complete system includes: Uprights with Worm Drive Winch, Patented Flex Net, Upright Padding and Antennae.**

Adjustable feet have up to 3" of fine tuning

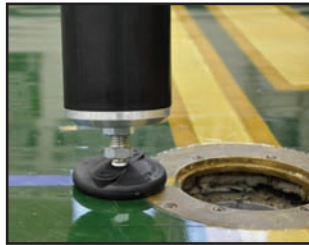

NEW telescoping option with our Carbon uprights



PVB-9000

LadyPro Carbon 3-1/2" Complete Women's System

PVB-8000 74 lbs. **\$4,295 system**

LadyPro Carbon 3-1/2" Uprights Only (includes winch)

PVB-80U 40 lbs. **\$3,399 pair**

LadyPro Carbon 3" Complete Women's System

PVB-8500 77 lbs. **\$4,395 system**

LadyPro Carbon 3" Uprights Only (includes winch)

PVB-85U 43 lbs. **\$3,499 pair**

Carbon Ultralite 3-1/2" Complete Telescoping System

PVB-9000 78 lbs. **\$5,295 system**

Carbon Ultralite 3-1/2" Uprights Only (includes winch)

PVB-90U 44 lbs. **\$4,399 pair**

Carbon Ultralite 3" Complete Telescoping System

PVB-9500 81 lbs. **\$5,395 system**

Carbon Ultralite 3" Uprights Only (includes winch)

PVB-95U 47 lbs. **\$4,499 pair**

Second Floor Competition Net Systems

These systems are designed for use where floor sleeves are impractical. Floor anchors are used instead of floor sleeves. The strong base design and world class uprights provide top level performance without the use of cables or wires. Meets all NCAA, NFHS and USVBA specifications. Designed for Collegiate and High School Level. 3-1/2" O.D. Aluminum uprights available with Infinite Height Adjustment range of 6' 6" to 8' 2" (PVB-2700) -OR- 16 Pin Stop Height Adjustment range of 6' 6" to 8' 2" (PVB-2500). Hand knob assemblies secure the steel T-bases to anchors in the floor for added safety and security. The standard pad as well as the base pad are included in these systems!

PVB-2700 Infinite Height Adjustment

Complete System

PVB-2700 202 lbs. **\$3,699 system**

Uprights Only (includes winch)

PVB-270UB 155 lbs. **\$2,699 pair**

Center Package

PVBC-270 **\$2,599 package**

PVB-2500 Pin Stop Height Adjustment

Complete System

PVB-2500 192 lbs. **\$3,179 system**

Uprights Only (includes winch)

PVB-250UB 145 lbs. **\$1,899 pair**

Center Package

PVBC-250 **\$1,799 package**



PVB-2700 or PVB-2500

New Recessed Pulley Wheel

Available with Pin Stop or Infinite Height Adjustment

See page 13 for Floor Anchors

Worm Drive Winch eliminates accidental back drive

2 hand knobs for added safety and security.



PVB-60P Post Pad see page 13

Standard pad and base pad are included in the above systems!

Replacement Base Pad For 2nd floor competition systems only. See page 13 for pad colors.

PVB-25P **\$299 pair**



See page 13 for Floor Anchor details
FP-89 **\$105 each**



FP-90 **\$89 each**



FP-100 **\$158 each**



NEW VOLLEYBALL SOCCER FOOTBALL LACROSSE BASEBALL FIELD MARKING SCOREBOARD BASKETBALL GYMNASIUM FIELD SEATING BALL STORAGE PHYS. ED. TENNIS

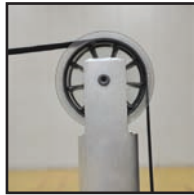

Recessed Pulley Wheel



Pin Stop Height Adjustment

Steel Collegiate Net System

Designed for International, Collegiate and High School Level. Durable steel uprights with 16 Pin Stop Height Adjustment range from 6' 6" to 8' 2". Uprights are designed to fit 3-1/2" diameter sleeves. See pages 6-7 for what is included in a complete system and center package. Refer to page 12 for measuring instructions.



Complete System

PVB-1500 152 lbs. **\$2,539 system**

Uprights Only (includes winch)

PVB-150U 118 lbs. **\$1,549 pair**

Center Package

PVBC-150 80 lbs. **\$1,449 package**

PVB-1500

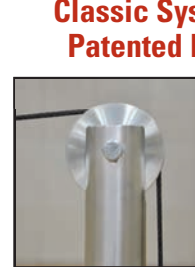

Recessed Pulley Wheel



Pin Stop Height Adjustment

Classic Steel Collegiate Net System

Designed for International, Collegiate and High School Level. Durable steel uprights with 16 Pin Stop Height Adjustment range from 6' 6" to 8' 2". Uprights are designed to fit 3" diameter sleeves. See pages 6-7 for what is included in a complete system and center package. Refer to page 12 for measuring instructions.



Complete System

PVB-3000 157 lbs. **\$2,539 system**

Uprights Only (includes winch)

PVB-30U 123 lbs. **\$1,549 pair**

Center Package

PVBC-300 93 lbs. **\$1,449 package**

PVB-3000

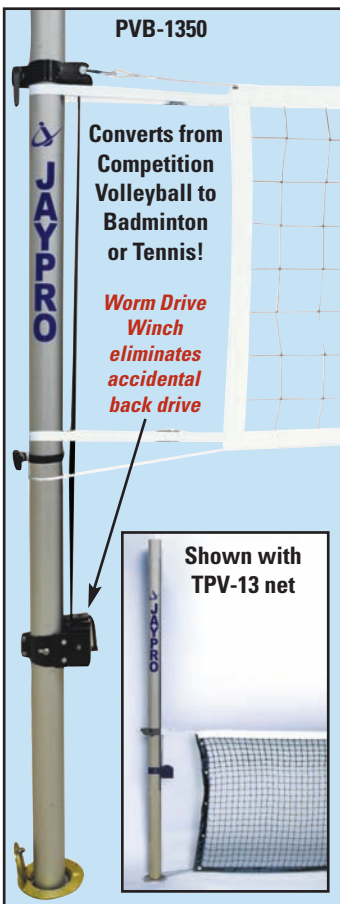

PVB-1350

Converts from Competition Volleyball to Badminton or Tennis!

Worm Drive Winch eliminates accidental back drive

Shown with TPV-13 net

Multi-Purpose Aluminum Net System

Easily converts from a competition volleyball net system to a badminton or tennis net system by adjusting the sliding collars. **10 Year Limited Warranty on uprights.** 3-1/2" O.D. Anodized Aluminum Upright. High School, Intramural and Recreational Competition. Infinite Setting Sliding Collar Height Adjustment. Uprights are designed to fit 3-1/2" diameter sleeves. Refer to page 12 for measuring instructions.

Complete System

(Includes uprights, competition net, standard pads, antennae)

PVB-1350 116 lbs. **\$1,995 system**

Uprights Only

(Includes winch)

PVB-13U 83 lbs. **\$1,329 pair**

Center Package

(Includes upright, winch, pad & net)

PVBC-130 51 lbs. **\$1,229 package**

Tennis Net (39" W x 36" L)

TPV-13 6 lbs. **\$189 each**



BSO-2U

Competition Badminton System

2-3/8" O.D. Steel Upright. High School, Intramural and Recreational Competition. Fixed Net Height.

Badminton System

BSO-2U 47 lbs. **\$569 pair**

Badminton Net

(Size: 30" W x 21" L)

BND-1 5 lbs. **\$52 each**

Floor Sleeve & Cover

2-3/8" I.D. x 10" deep.

BSO-2G

Brass 23 lbs. **\$349 pair**

BSO-2G-CP

Chrome 23 lbs. **\$349 pair**

See page 12 for Floor Sleeve details

"Flex Net" International

Designed for International, Collegiate and High School competition. The Patented Flex Net eliminates all cumbersome cables and replaces them with heavy-duty woven nylon top and bottom bands. The headband attaches directly to the winch leader strap to provide superb net tension. Patent # 5,358,257. Due to varying court sizes, the net body may not match your court width.

Best Seller!

"Flex Net" International				
Item	For Uprights set between	Net Size	4' Strap Included	Price
PVBN-6	35' - 37'	39"W x 32'L	No	\$469 each

Alternate Size Nets				
Item	For Uprights set between	Net Size	4' Strap Included	Price
PVBN-628	30' - 32'	39"W x 28'L	No	\$429 each
PVBN-628ADJ	32' - 35'	39"W x 28'L	Yes	\$469 each
PVBN-6ADJ	37' - 40'	39"W x 32'L	Yes	\$498 each



Flex Net Offers Superb Net Tension and Quick & Easy Set-up!

48 HOUR QUICK SHIP



No extra cables or tie offs!

Adjustable straps designed to attach to the existing bottom band for additional length.

Don't have a Jaypro system but want the benefits of the Flex Net? No Problem... The Flex Net will adapt to most existing system uprights!

Flex Net with Adapter Cords

Includes patented Flex Net (PVBN-6) with 1/4" diameter anchor cord and clips. The adapter cords connect your existing winch and anchor upright to the top of the Flex Net. Can be used on most manufacturers' systems such as Porter, Senoh, Spalding, Bison, MacGregor, Stackhouse, Schelde or other similar systems. (Anchor cord to be cut to length in the field to adapt to your specific system.)

PVBN-6AK 14 lbs. **\$498 each**

Flex Net with Adapter Strap

Includes patented Flex Net (PVBN-6) with 2" W adjustable strap. The adapter strap "bridges" the top of the Flex Net to the anchor upright. Can be used on Schelde or other similar systems.

PVBN-6J 13 lbs. **\$479 each**

48 HOUR QUICK SHIP

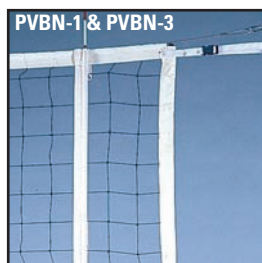
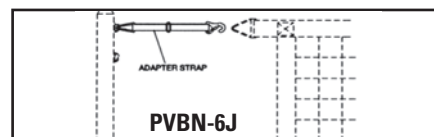
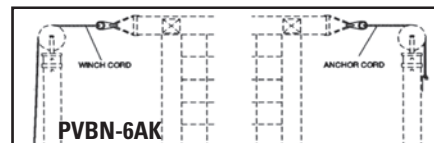

High School Net

High school competition net for Jaypro's PVB-1350, OCV-900 and similar net systems. Twin quick-lock side tension straps ensure proper net tension. **36"W x 32'L**.

PVBN-1 12 lbs. **\$209 each**

Collegiate Net

Collegiate competition net is same as PVBN-1 only the size is **39"W x 32'L**.

PVBN-3 13 lbs. **\$229 each**

Best Seller!

48 HOUR QUICK SHIP

Volleyball Net (Our best nylon, rope cable)

VBN-32 36"W x 32'L 4 lbs. **\$92 each**

Volleyball Net (2.5 mm poly with rope cable)

VBD-6 36"W x 32'L 4 lbs. **\$83 each**

Volleyball Net (2.5 mm poly with steel cable)

VBD-3 36"W x 32'L 5 lbs. **\$89 each**

Badminton Net (Lightweight with rope cable)

BND-1 30"W x 21'L 5 lbs. **\$52 each**

Tennis Net (Lightweight with rope cable)

TDP-42 39"W x 42'L 7 lbs. **\$148 each**



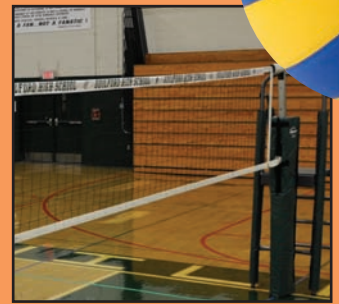

Custom Volleyball Net Tape A perfect way to show school spirit (where regulations allow). Customized vinyl tape with hook and loop attachment. Sized for a 32' net, 3" high. Team Pink selection now available. Extended lead time applies. Contact Customer Service for artwork details. Does not ship from Jaypro's CT warehouse. Call for freight quote.

CVNT-1

3 lbs.

\$349 each

CVNT-1PK

3 lbs.

\$349 each

Store those nets securely, neatly and easily in minimal space. Constructed of rigid thick wall 1.5" square steel tube and transported by three 4" non marring swivel casters. Head band is wound cleanly and tangle free. Powder coated blue for years of surface protection. For additional protection, net storage bags are included.



Easily wind your nets on a free standing, transportable rack to keep your nets clean and tangle free. Visit us online at www.jaypro.com/videos to see the Net Keeper in action!



Single Net Keeper

Holds 1 net, 1 bag provided.

VNK11 20 lbs. **\$239 each**



Double Net Keeper

Holds 2 nets, 2 bags provided.

VNK22 24 lbs. **\$269 each**



Triple Net Keeper

Holds 3 nets, 3 bags provided.

VNK33 42 lbs. **\$309 each**

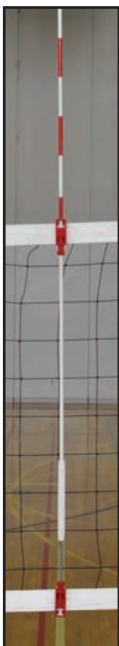

Antennae

Official antennae quickly clamps directly to the top and bottom of the net. Attachment adjustments are made easily from the floor. Fits both 36" and 39" nets. 72" long, red and white.

VBA-80 3 lbs. **\$148 pair**



VBA-80



VBA-4

Antennae

2 piece antennae slide into hook and loop attached sleeve. Fits 36" or 39" wide nets.

VBA-4 3 lbs. **\$106 pair**



Don't let this happen to your net, secure it with a net bag only from Jaypro!



Replacement Net Keeper Storage Bag

Protection for your nets, keeps cords and cables off the floor.

VNKBAG 1 lb. **\$29 each**



Boundary Tapes

2" white boundary tapes with hook-and-loop closure. Fits 36" or 39" wide nets.

VA-22 1 lb. **\$29 pair**

Best in the Industry!

Chrome Finish
PVB-75CVR-CP

Brass Finish
PVB-711



PVB-70S

Generally, floor sleeves are 3", 3-1/2" or 4". Jaypro uprights are either 3" or 3-1/2". To ensure a proper fit, measure your existing floor sleeves prior to selecting a system. (See below for measuring instructions). Select the appropriate adapter (bottom of page) that fits your measurements and system of choice.

Do not measure cover plate

Measure the distance between red arrows for accurate dimension

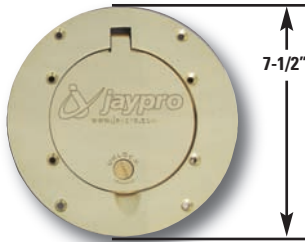

7-1/2"

Floor Sleeve & Cover - 3-1/2"

Sleeves are 3-1/2" I.D. x 10" deep. Lockable hinged cover plate is 7-1/2" O.D. and is made of heavy cast brass or chrome to prevent basketball dead spots.

PVB-75S	Brass	22 lbs.	\$419 pair
PVB-75S-CP	Chrome	22 lbs.	\$419 pair



Floor Sleeve & Cover - 3"

Same as PVB-75S except sleeve is 3" I.D. x 10" deep.

PVB-70S	Brass	22 lbs.	\$419 pair
PVB-70S-CP	Chrome	22 lbs.	\$419 pair



- See below for reducing your floor sleeve diameter! -

Floor Sleeve & Cover - 2-3/8"

Same as PVB-75S except sleeve is 2-3/8" I.D. x 10" deep.

BSO-2G	Brass	23 lbs.	\$349 pair
BSO-2G-CP	Chrome	23 lbs.	\$349 pair

Cover Plate Only

PVB-711	7-1/2"	Brass	6 lbs.	\$189 each
PVB-75CVR-CP	7-1/2"	Chrome	6 lbs.	\$189 each
PVB-85CVR	8-1/2"	Brass	7 lbs.	\$199 each

Second Floor Sleeve Bracket

For second story installation of floor sleeves or where there is less than 12" of clearance in the sub-floor. Mounting hardware not included.

SB-10	67 lbs.	\$289 each
--------------	---------	-------------------

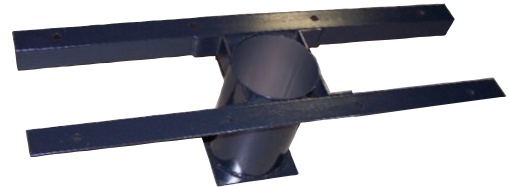

Sleeve Inserts

Sleeve insert used to **make deeper floor sleeve a shorter depth**. Specify current depth and inside diameter when ordering.

PVB-DEP	6 lbs.	\$69 each
----------------	--------	------------------

SVL-3238	Modifies your 3" inside diameter to 2-3/8" ID*	12 lbs.	\$72 each
PVB-ID	Modifies your 3-1/2" inside diameter to 3" ID*	8 lbs.	\$62 each
SVL-3528	Modifies your 3-1/2" inside diameter to 2-3/8" ID* 14 lbs.		\$79 each
SVL-4035	Modifies your 4" inside diameter to 3-1/2" ID*	9 lbs.	\$66 each

* Specify sleeve depth when ordering.

Depths other than the standard 10" are special order items (non-returnable). Custom sizes (depths) may require longer lead time.

SLEEVE INSERT MEASUREMENT

To ensure proper fit of sleeve inserts, please provide the following dimensions of your sleeves when ordering.

- A) Depth of sleeve itself
- B) Depth from bottom of sleeve to playing surface
- C) Inside diameter of sleeve

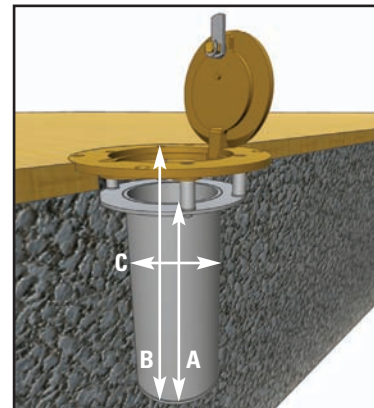

Floor Anchors

Floor Anchor

Billet steel body gives 9000 lb. pullout strength intended for all floor applications except floating wood floors. 3-1/4" chrome cover. Center is 1/2"-13 thread with spring loaded closure plug.

May also be used without the extension bolt on wood, tile or synthetic surfaces applied directly over concrete slab, or on a floating wood floor for light duty performance.

FP-89 3 lbs. **\$105 each**

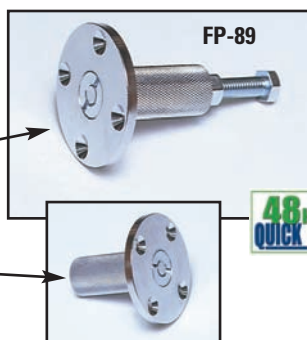

Floor Anchor

Brass cover plate and anchor work independently to allow for installation into floating wood floors.

FP-100 4 lbs. **\$158 each**

Floor Anchor

Same construction as FP-89 except cylinder width is only 1-1/2".

FP-90 3 lbs. **\$89 each**



All floor anchors come with our exclusive removable cylinder in case stripping occurs.



Padding



Official Standard Pad

6'H post pad constructed of 2" thick polyurethane foam wrapped in 14 oz. vinyl in your choice of color. Attaches with hook and loop closure flaps. Meets specifications for competitive play. Specify color from chart below when ordering. Shown with optional custom lettering.

PVB-60P 18 lbs. **\$429 pair**

Custom Lettering

Put your school name on your pads! White vinyl letters as shown. 3-9 letters on one side of one pad.

PVL-39 white lettering **\$159**

PVB-60P
Standard Pad
shown with
custom lettering

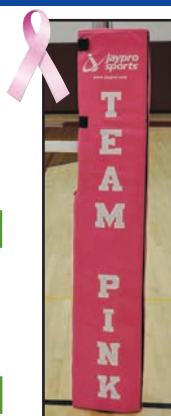

Cable/Buckle Cover

Vinyl covered foam with hook-and-loop attachment protects against exposed net cables and buckles. Pad is 12" long. White only.

VCC-12 4 lbs. **\$64 pair**

NEW Pad Color Choices, Colors displayed may not be an exact match

pink	red	navy blue	yellow	light blue	gray	black	maroon	forest green	kelly green	royal blue	tan	purple	orange

System Accessories



Wall Rack

Heavy-duty steel rack attaches to wall and holds 3 posts in upright position for easy storage.

VBWR-1 8 lbs. **\$185 each**

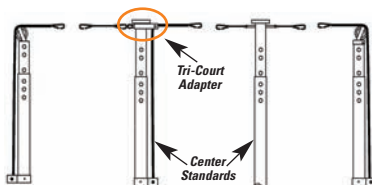

Volleyball System Tri-Court Adapters

Connects two center standards into a third court. Improves the tension out of middle net. Easily attaches onto existing center standards. 7" H x 3"

PVB-303CAK For PVB-3000 system 6 lbs. **\$139 each**

PVB-35TCA For PVB-7000, 6500, 5000, 4500 & 1500 systems 6 lbs. **\$139 each**

PVBWINCH Worm Drive Winch Replacement includes leader strap & handle 6 lbs. **\$369 each**

HM5044 Cargo Buckle Winch Replacement 3 lbs. **\$72 each**

PVB101A Leader Strap for HM5044 2 lbs. **\$52 each**

PVB603 Leader Strap for PVBWINCH 1-1/2" W 1 lb. **\$62 each**

VBW-HANDLE-08 Handle for PVBWINCH - (For winches purchased after 2008) 1 lb. **\$52 each**

PVB6071 Handle for Telescoping Height Adjustment & Old Blue Style Winch (Requires a 3/8" Allen Wrench) 1 lb. **\$32 each**

PVB512 Pin Chain Assembly 1500/5000/4500 2 lbs. **\$12 each**

NEW VOLLEYBALL SOCCER FOOTBALL LACROSSE BASEBALL FIELD MARKING SCOREBOARD BASKETBALL GYMNASIUM FIELD SEATING BALL STORAGE PHYS. ED. TENNIS



The most durable stand on the market! Shown with VRS-60P optional padding.

Introducing a MEGA addition to our Referee Stands!



Easily folds and rolls for storage.

The "MEGA REF" Folding Referee Stand

The most durable stand on the market! Constructed of 1-5/8" O.D. heavy wall steel with a durable powder coated finish. Includes a welded frame platform support, four legs with protective rubber tips and four 4" non-marring wheels in the front for easy transport. Folds to 84"H x 30"W x 10"D for compact storage. Vinyl coated, padded platform for referee comfort is 48" above the floor.

VRS-8000 82 lbs. **\$849 each**

Constructed of 1-5/8" heavy wall powder coated pipe

Vinyl coated and padded platform for referee comfort

All welded frame support with non-slip foot treads

Double wheels on each leg for easy transport

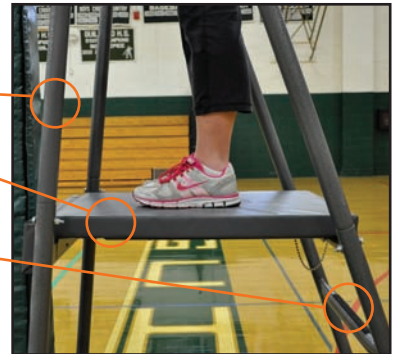

VRS-6000 with VRS-60P pad

Folding Referee Stand

This free standing referee stand can be used with any net system. Sturdy 1-5/16" diameter powder coated steel frame has 4 legs with protective rubber tips and 4" non-marring wheels in the front for easy transport. Folds to 84"H x 30"W x 10"D for compact storage. Vinyl coated, padded platform is 48" above the floor. Shown with optional padding.

VRS-6000 64 lbs. **\$629 each**



Easily folds and rolls for storage.



VRS-3000 with VRS-30P pad



Adjustable Referee Stand*

Clamps onto any telescoping pole net system. Sturdy 1-5/16" diameter powder coated steel frame with 2 leg design. Telescoping feet allow height adjustment. Includes wheels for easy transport and vinyl coated, padded platform. Shown with optional padding. *Please note: This Referee Stand does not fit PVB-1350 or OCV-900 systems

VRS-3000 55 lbs. **\$659 each**



Referee Stand Pad for the VRS-8000 & VRS-6000

Fits both the VRS-8000 and VRS-6000 referee stand. 1" thick polyurethane foam wrapped in 14 oz. vinyl in your choice of color. Meets specifications for competitive play. Specify color from chart below when ordering.

VRS-60P 18 lbs. **\$306 each**



Referee Stand Pad for the VRS-3000

Same specifications as the VRS-60P but fits the VRS-3000 referee stand.

VRS-30P 18 lbs. **\$289 each**

Pad Color Choices Colors displayed may not be an exact match



4 Standard Carrier



EC-500

6 Standard Carriers

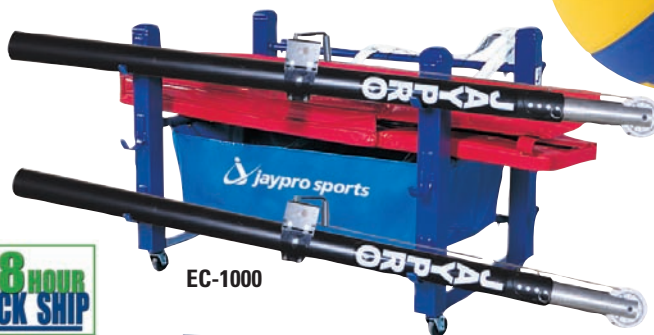

EC-1000



Heavy duty welded steel frame transports and stores volleyball uprights, nets, pads and other equipment. Comes with a tough, blue powder coated finish. Large casters provide smooth portability. Deluxe and Vertical models include vinyl storage bag.

EC-500	Standard	42" L x 32" W	Holds 4 poles	51 lbs.	\$329 each
EC-1000	Deluxe	48" L x 36" W	Holds 6 poles	77 lbs.	\$499 each
VEC-1	Vertical	60" L x 35" W	Holds 6 poles	98 lbs.	\$299 each



VEC-1



HSVBC24

Back-saving height for quick and easy access to the balls!



Hammock Drill Cart

Features a low profile making it easier to turn, reach and spike. Sturdy steel frame is collapsible for easy storage. Includes matching nylon carry bag with shoulder strap. Holds up to 24 balls. 48" L x 22" W x 12" D x 40" H.

HSVBC24	21 lbs.	\$159 each
----------------	---------	-------------------

ToteMaster™ Open Top Storage Cart



TE-PE01

Two full size open top storage baskets for storage of volleyball equipment. Holds 33 volleyballs, net, pads and other equipment. Two 360° hangers rotate for storage. Swivel casters for easy indoor transport. Powder coated frame for extra durability. Size: 48" L x 26" W x 54" H.

TE-PE01	48 lbs.	\$249 each
----------------	---------	-------------------



BC3

Wide-Body Ball Carts

BC3 holds 12 balls or BC4 holds 16 balls with a wide body design for stability. Heavy duty steel frame with chrome finish. Easy assembly.

Three-Tier

39-1/2" H x 8-1/2" W x 39" L

BC3	15 lbs.	\$70 each
------------	---------	------------------

Four-Tier

39-1/2" H x 8-1/2" W x 51-1/2" L

BC4	19 lbs.	\$75 each
------------	---------	------------------

Deluxe Ball Carriers

The most rugged and durable carriers available today. Innovative easy access design holds up to 15 or 21 volleyballs. All welded 1" O.D. steel side frames. 1" O.D. steel crossbars. Four heavy-duty swivel casters for portability. Tough powder coated finish. **Lifetime Warranty on frame and casters!**

15 Ball Carrier

36" H x 22" W x 39" L

BBC-12RB	Royal Blue
BBC-12BK	Black
BBC-12RD	Red

27 lbs.	\$149 each
---------	-------------------

21 Ball Carrier

36" H x 22" W x 60" L

BBC-18RB	Royal Blue
BBC-18BK	Black
BBC-18RD	Red

41 lbs.	\$172 each
---------	-------------------



BBC-12BK



BC4

Your choice of three colors!





TS612

The Spiker

Used to develop spiking and serving skills. 6' to 12' aluminum telescoping pole with foam ball holder. Includes polyethylene base.

TS612

11 lbs.

\$239 each



TJ612

The Jumper

Used to measure jump reach. Color coded spring pegs in 1" increments. 6' to 12' aluminum telescoping pole. Includes polyethylene base.



TJ612 10 lbs.

\$199 each



TA115

The Attacker

Used for game-like blocking situations. Two adjustable 1' x 1.5' foam blocking surfaces. Four knobs for easy adjustment. Includes polyethylene base.



TA115 15 lbs.

\$299 each



TB11

The Blocker

Used for defending the blocked spike. Aluminum pole adjusts up to 11' and includes 2' x 3' foam blocking surface. Includes polyethylene base.



TB11 13 lbs.

\$289 each

Package Deal on Training Equipment...

Purchase The Spiker, The Jumper, The Attacker and The Blocker as a PACKAGE and SAVE!



VTAPACK

49 lbs.

\$709 package

(price if purchased separately \$1,026)

A SAVINGS OF \$317



Make it easier to train on your own with the optional royal blue polyethylene base.



Optional Polyethylene Base (Fillable with sand)

FPB1

13 lbs.

\$40 each

Other Attack Volleyball Machines are available at www.jaypro.com

Shown with optional ball bag, purchase separately on page 71

Attack II Volleyball Machine



The Attack II delivers thousands of reps in daily practice of serve receiving, digging and spiking. Accuracy and repeatability are assured in every drill, eliminating time-wasting errant hits. With a ball release point of 5'6" to 8'-6", it offers a full range of spins, throwing both sharp topspins and breaking floaters to simulate match situations. Spiking over Women's net at speeds up to 70 MPH. Fits through a standard doorway and into any standard size SUV or pick-up.

VBSA-2

190 lbs.

\$3,149 each



4" x 4" Extruded Heavy Wall Aluminum with additional lateral support

Never replace your wood poles again!

OCC-500

Coastal Competition

4" square extruded heavy wall aluminum uprights designed to withstand coastal winds and weather. Adjustable winches for play at any height. Includes ground sleeves, installation tool, 2 winches and weather resistant net. **Limited Lifetime Warranty on uprights.**

OCC-500 178 lbs.

\$1,395 system



Replacement Net

OCC-500N 8 lbs.

\$179 each



OCV-900

Competition Outdoor Volleyball

3-1/2" O.D. powder coated steel uprights with fixed net heights for men and women's play. Includes rust resistant ratchet and 36" aluminum ground sleeves with top caps. Nets available separately, see page 10 (PVCN-6J shown or PVCN-1). **According to FIVB regulations, the sand must be at least 15-3/4" deep and composed of fine, loosely compacted grains. This system will accommodate from 12" to 16" of sand.**

OCV-900 170 lbs.

\$999 system



OS-350

Recreational Outdoor Volleyball

2-3/8" O.D. galvanized steel uprights accommodate volleyball, badminton or tennis. Includes rust resistant ratchet and PVC ground sleeves with top caps. Nets available separately, see page 10. (VCN-32, VBD-6 or VBD-3)

OS-350 80 lbs.

\$599 system



Center Package

OCV-900C 90 lbs.

\$589

Note: Sleeves are designed to be set even with the playing surface. Contact factory for special installation requirements.



Adjustable Volleyball Court Line

Durable 2" wide black webbed volleyball boundary line adjusts from 30' x 60' to FIVB regulation 8m x 16m. Includes four 8" corner stakes with bungee cord to ensure adjustment to court boundary. Includes plastic reel for easy assembly and storage.

AVCL-2 2 lbs.

\$59 each

Soccer Goal Safety is our Business!

SECURE 4 SAFETY

Check It - Secure It - Test It - Respect It



Jaypro Sports is committed to safety on the field. Because of this we have created the Secure 4 Safety Program, which promotes soccer goal safety.

ASTM TESTING



In our ongoing effort to provide athletes with the safest environment possible, Jaypro has worked with the ASTM (American Standards for Tests and Measurement) to create new standards for portable soccer goals in the U.S. The goals in this catalog so marked have been tested in accordance with the standards set forth by the ASTM committee for portable soccer goal safety. (ASTM Designation: F2056 and F2673). The United States Consumer Product Safety Commission has determined that portable official soccer goals should be anchored or counter-weighted at all times.

All Jaypro goals that meet NFHS, NCAA and FIFA specification are marked in this section, refer to www.jaypro.com for more information on ASTM guidelines and standards.

ANCHOR OPTIONS

Throughout the Soccer section, Jaypro has listed the counterweight required for each soccer goal, like the icon shown below. Even with the ASTM requirement met in our testing, all soccer goals that are not permanently anchored must have a certain counterweight required on the rear frame of the goal. Our new labeling system will also inform you on the weight that is required on each goal. Please refer to www.jaypro.com for a complete list of counterweight requirements for your particular goal. On-goal weights and in-ground anchors are available on pages 31-32 of this section.



**IN-GROUND ANCHORS
OR 140 LBS. OF
COUNTERWEIGHT
REQUIRED PER GOAL**



Model #: **SGP-600**
800-243-0533
www.jaypro.com

THIS GOAL MEETS ALL SAFETY REQUIREMENTS OF: ASTM F2056 & ASTM F2673
WHEN COUNTER BALANCE WEIGHT IS USED AS THE ONLY MEANS OF PREVENTING TIPOVER, A MINIMUM OF 140 LBS. MUST BE PLACED ON THE REAR CROSSBAR. WEIGHT SHOULD BE DIVIDED EQUALLY AND PLACED NEAR EACH REAR CORNER.

SEE MANUFACTURER'S INSTRUCTIONS FOR MORE DETAILS ON ANCHORING.

SL0046

OUR GUARANTEE

Jaypro Sports "Honest Guarantee"

Don't be fooled by misleading "lifetime guarantees" in the industry. They often aren't accurately defined when reading the fine print, leaving customers confused and frustrated. Jaypro is proud to offer "The Honest Guarantee." Our official soccer goals are designed and manufactured with the highest standards in quality and safety that we can confidently guarantee them against defects and workmanship. All Official and NOVA goals are guaranteed for 12 years. All nets and vinyl products are guaranteed for 1 year. Any product without a specific guarantee listed is guaranteed for 3 years.

It's that simple!



Simply the BEST Soccer Goals in the Industry... go ahead and compare!

InNOVATM Series Soccer

Exclusive Jaypro Features Include:



Flush Net Clips



Easy TrackTM Net Clips



Optional Easy Attach Wheel Kits



Auxiliary Backstays on some units



Jaypro Powder Coat



ASTM Certified

NOVA UltimateTM Folding

SGP-600FS

Shown with optional two-tone net!

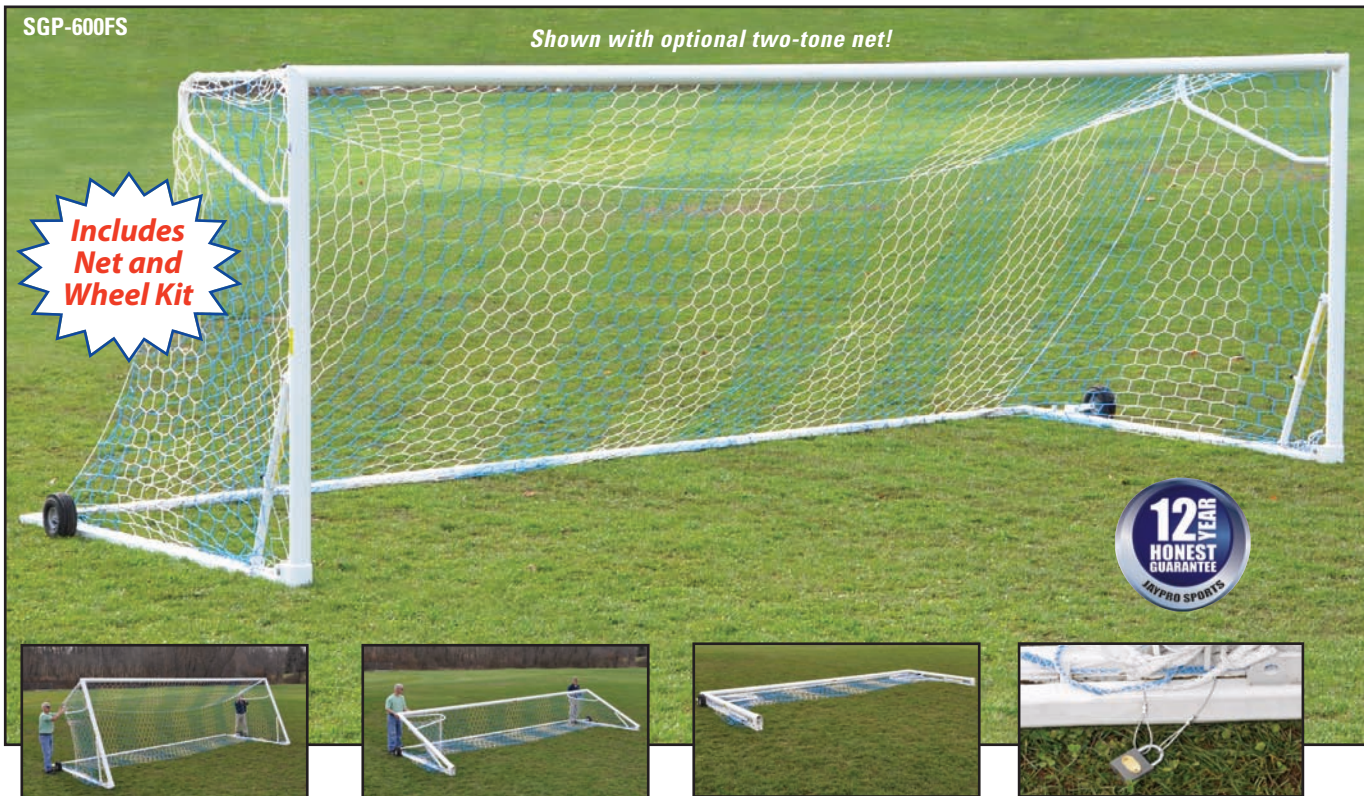

Step 1: X-clusive **Patented** spring aided design ensures goal folds safely



Step 2: Fold in backstays



Step 3: Locks in folded position for storage and safety



Prevent unsupervised use and accidental tip over (with customer supplied lock)

The Safest Portable Soccer Goal in the World! Patented spring assist designs allows goal to be raised or lowered in minutes. Official size 8' H x 24' W x 4' B x 10' D. Powder coated goal is 4" O.D. extruded aluminum with a 2" x 4" base frame and 1.7" O.D. aluminum backstays. Features exclusive flush mount Easy TrackTM net attachment system and stainless steel hardware. Meets NFHS, NCAA and FIFA specifications. **Includes 4mm white official net and 10" no-flat wheels.** Ground anchors (pages 31-32) available separately.

SGP-600FS

475 lbs.

\$5,595 pair



IN-GROUND ANCHORS OR 140 LBS. OF COUNTERWEIGHT REQUIRED PER GOAL



Jaypro XCLUSIVE Easy TrackTM Net Clips

NEW VOLLEYBALL SOCCER FOOTBALL LACROSSE BASEBALL FIELD MARKING SCOREBOARD BASKETBALL GYMNASIUM FIELD SEATING BALL STORAGE PHYS. ED. TENNIS

NOVA Premiere™

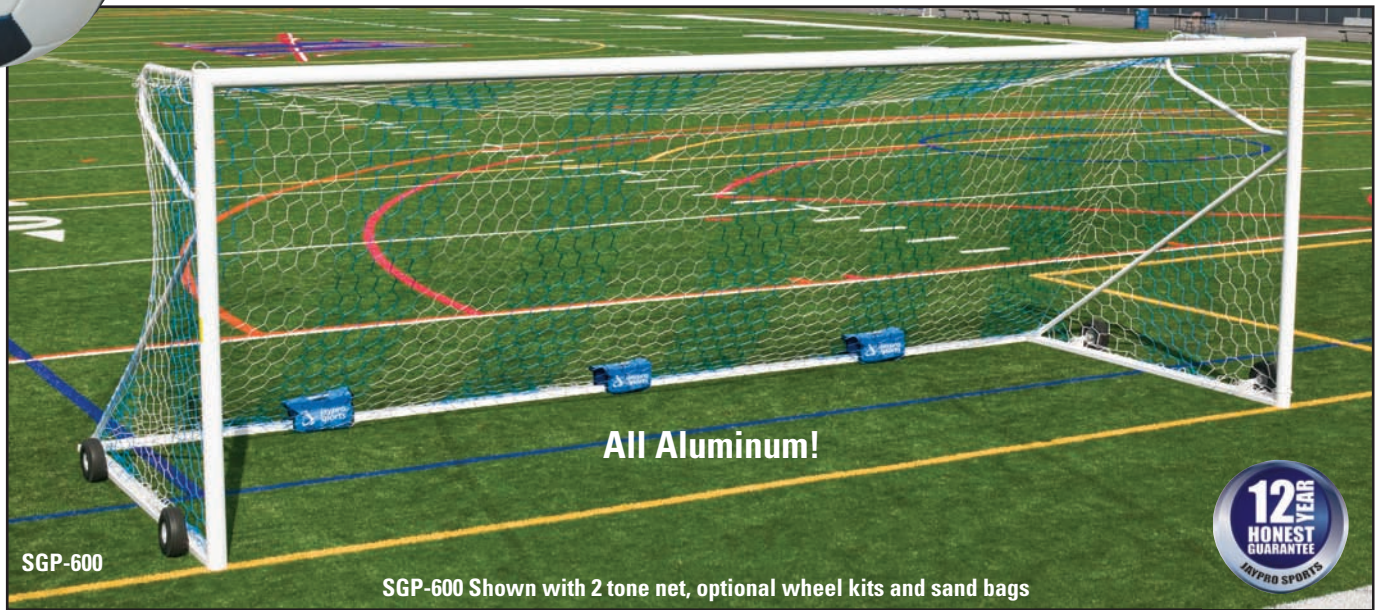

SGP-600 Shown with 2 tone net, optional wheel kits and sand bags

International style, all aluminum goal. Official size 8' H x 24' W x 4' B x 10' D. Powder coated goal is 4" O.D. extruded aluminum with a 2" x 4" base frame and 1.7" O.D. aluminum European and auxiliary backstays. Features exclusive flush mount Easy Track™ net attachment system. Meets NFHS, NCAA and FIFA specifications. Ground anchors (pages 31-32), wheel kits (below) and nets (page 30) available separately.

SGP-600

446 lbs.

\$4,795 pair



**IN-GROUND ANCHORS
OR 140 LBS. OF
COUNTERWEIGHT
REQUIRED PER GOAL**



**Jaypro
XCLUSIVE**
Easy Track™
Net Clips

NOVA Premiere™ Adjustable



SGP-600AX

Same as the SGP-600 but has an infinitely adjustable rear crossbar allowing the goal to fit under any football goal post. No fixed settings, No fixed depth on the rear crossbar, move it a yard, a foot or an inch! To attach the goal securely to the goal post see (page 41) for details. Ground anchors (pages 31-32), wheel kit (right) and nets (page 30) available separately.

SGP-600AX

364 lbs.

\$4,989 pair



NOVA Premiere™ Soccer Packages

- 1 pair **SGP-600** NOVA Premiere Official Goals
- 1 pair **SN-2BLKW** 5mm, 5.5" hex mesh two tone white/black nets
- 2 sets **SAS-95** Auger anchors
- 1 set **NSGWK** NOVA Goal wheel kit

A SAVINGS OF \$482

SGP-600PKGBLK 531 lbs.

\$5,199 package

- 1 pair **SGP-600** NOVA Premiere Official Goals
- 1 pair **SN-2BLUW** 5mm, 5.5" hex mesh two tone white/blue nets
- 2 sets **SAS-95** Auger anchors
- 1 set **NSGWK** NOVA Goal wheel kit

A SAVINGS OF \$482

SGP-600PKGBLU 531 lbs.

\$5,199 package

NSGWK

Optional Wheel Kit

Includes 4 large 10" "no flat" tires. Easily attaches to any NOVA base. (SGP-600, and NOVA Club round and square). Wheel engagement is quick and easy. One kit fits 2 goals.

NSGWK

45 lbs.

\$449 kit



World™ Fold-Up



SGP-660



This all aluminum, international style goal is field maintenance friendly with a fold-up rear frame that can be temporarily pinned or permanently locked in a raised position for mowing. Official size 8' H x 24' W x 6' B x 6' D. Powder coated goal is 4" O.D. extruded aluminum with a 2" x 4" base frame and three 2-3/8" galvanized steel back posts. Features exclusive flush mount Easy Track™ net attachment system and stainless steel hardware. Includes ground sleeves for semi-permanent installation and world competition Hex net. Meets NFHS, NCAA and FIFA specifications.

SGP-660

534 lbs.

\$4,795 pair



Classic World™ Semi-Permanent



SGP-550

Same as the SGP-660 but without the fold-up rear frame.

SGP-550

432 lbs.

\$3,395 pair



Jaypro
XCLUSIVE
Easy Track™
Net Clips

Soccer Field Netting

FieldPro Soccer Ball Stop System 20' x 65'

Stop wasting time during practices and games chasing missed shots or errant passes and ensure the safety of athletes, coaches and spectators on adjacent fields. 20'H x 65'L backstop is designed specifically to fit behind soccer goals. Includes four 4" O.D. heavy wall aluminum uprights with black powder coated finish, ground sleeves, corrosion resistant hardware and 3-1/2" square mesh #36 knotless nylon black net with 1/4" rope border. Net can easily be raised and lowered with a rope and pulley system. Custom sizes also available, see pages 97-99.

FNSB-65

250 lbs.

\$2,095 each

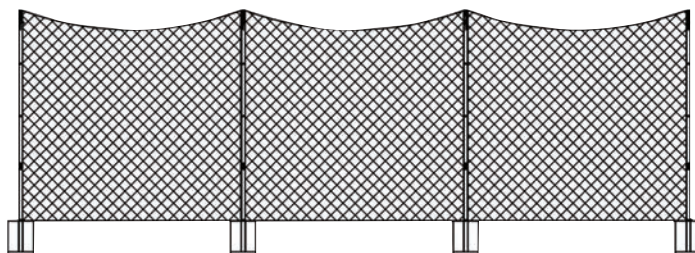

Classic™ Official Round

Classic™ Official Square



Shown with SN-2BLUW hex net.

A true Jaypro Classic. Official size 8' H x 24' W x 4' B x 10' D. Powder coated goal is 4" O.D. for the round goal or 4" square extruded aluminum with 1.9" O.D. galvanized steel backstays and rear crossbar. Features exclusive flush mount Easy Track™ net attachment system. Meets NFHS, NCAA and FIFA specifications. Ground anchors (pages 31-32), nets (page 30) and wheel kits (below) available separately. Semi-permanent goals, European backstays and ground sleeves available below.

SGP-400

420 lbs.

\$2,795 pair



SGP-760

416 lbs.

\$2,795 pair



IN-GROUND ANCHORS OR 160 LBS. OF COUNTERWEIGHT REQUIRED PER GOAL



Classic Wheel Kit

Includes 4 large 10" "no flat" tires with fasteners for attachment to goals, SGP-760, SGP-400 and SGP-100. One kit fits 2 goals.

CSGWK

45 lbs.

\$449 kit



IN-GROUND ANCHORS OR 140 LBS. OF COUNTERWEIGHT REQUIRED PER GOAL

Classic™ Official Soccer Packages

- 1 pair **SGP-400** Classic Round Official Goals
- 1 pair **SND-8** 4mm, 5.5" square mesh white nets
- 2 sets **SAS-95** Auger anchors
- 1 set **CSGWK** Classic Goal wheel kit

A SAVINGS OF \$362

SGP-400PKG

496 lbs.

\$3,249 package

- 1 pair **SGP-760** Classic Square Official Goals
- 1 pair **SND-8** 4mm, 5.5" square mesh white nets
- 2 sets **SAS-95** Auger anchors
- 1 set **CSGWK** Classic Goal wheel kit

A SAVINGS OF \$362

SGP-760PKG

500 lbs.

\$3,249 package

Classic™ Official Round Semi-Permanent

Same features as the SGP-400 but with 10' long uprights for insertion into the ground.

SGP-440 Galvanized Steel Backstays 306 lbs. **\$2,398 pair**

SGP-440EB European Backstays 306 lbs. **\$2,498 pair**

SGP-445G Ground Sleeves (set of 4) 28 lbs. **\$479 set**



SGP-440 (round) and SGP-730 (square)

Classic™ Official Square Semi-Permanent

Same features as the SGP-760 but with 10' long uprights for insertion into the ground.

SGP-730 Galvanized Steel Backstays 241 lbs. **\$2,398 pair**

SGP-730EB European Backstays 241 lbs. **\$2,498 pair**

SGP-735G Ground Sleeves (set of 4) 28 lbs. **\$479 set**



SGP-440EB (round) and SGP-730EB (square)



Jaypro XCLUSIVE
Easy Track™ Net Clips



NEW VOLLEYBALL SOCCER FOOTBALL LACROSSE BASEBALL FIELD MARKING SCOREBOARD BASKETBALL GYMNASIUM FIELD SEATING BALL STORAGE PHYS. ED. TENNIS

Team™ Official Square



Available in Two Sizes!

Budget friendly goals. Official size 8' H x 24' W x 4' B x 10' D and Junior size 7' H x 21' W x 3' B x 8' D. Powder coated goal is 4" x 2" steel with 1.9" O.D. galvanized steel backstays and rear crossbar. Features "money clip" style net attachment system. Meets NFHS and NCAA specifications. Ground anchors (pages 31-32), nets (page 30) and wheel kits (below) available separately.

SGP-100 Team Official 571 lbs. **\$2,195 pair**  **SGP-100JR** Team Junior 485 lbs. **\$1,795 pair**



IN-GROUND ANCHORS OR 170 LBS. OF COUNTERWEIGHT REQUIRED PER GOAL



Comes with exclusive "money clip" style net attachment



IN-GROUND ANCHORS OR 190 LBS. OF COUNTERWEIGHT REQUIRED PER GOAL



Classic Wheel Kit
Includes 4 large 10" "no flat" tires with fasteners for attachment to goals, SGP-760, SGP-400 and SGP-100. One kit fits 2 goals.

CSGWK 45 lbs. **\$449 kit**

SAFETY FEATURES



Rear ground crossbar and steel backstays improve stability and safety.

Backstays run back 10' for a more stable base as opposed to 8' and 9' like most other goals.

Ground anchors are recommended, see pages 31-32.

Team™ Official Round Semi-Permanent



A Military Favorite! Official size 8' H x 24' W. Powder coated uprights and crossbar are 4" O.D. 14 gauge steel. Designed without backstays for permanent/semi-permanent installation. Includes nets, net clips and net pegs. Ground sleeves for semi-permanent installation available separately.

Ground Sleeves for Semi-Permanent Installations
Aluminum ground sleeves for semi-permanent installation of SGP-200. Includes locking cap. Each set includes four sleeves.

SGP-200 280 lbs. **\$1,795 pair** 

SGP-200G Ground Sleeves (set of 4) 28 lbs. **\$479 set**

Jaypro InNOVation™ “CLUB GOALS”

The safest, most durable Club Goals in the industry!

Powder coated, all aluminum, portable goal offers a full ground base frame made of 4" x 2" extruded aluminum. Features flush mount Easy Track™ net attachment system and stainless steel hardware. Exclusive 1-5/16" European and auxiliary backstays for a unique look. Available with 3" O.D. or 4" x 2" extruded front frame. Entire goal is powder coated white... tough and durable! All NOVA Club Goal packages come complete with one pair of goals, one pair of 4" square mesh white nets, Easy Track™ net clips and a set of eight Auger style anchors. For additional styles of anchors, see (pages 31-32). Optional wheel kits are available separately (below).

Complete Set Includes:



Round or Square Club Goal



Nets



Easy Clips™



Auger style Anchors



Easy Track™ Net Clips



3" O.D. Round Frame



4" x 2" Square Frame

NOVA Club™ Round

NOVA Club™ Square

NOVA Club Round	Weight	Counter Weight	Size	Price	NOVA Club Square	Weight	Counter Weight
RCG-24S	402 lbs.	150 lbs.	8'H x 24'W x 4'B x 9'D	\$3,659 set	SCG-24S	472 lbs.	140 lbs.
RCG-21S	358 lbs.	170 lbs.	7'H x 21'W x 3'B x 8'D	\$3,379 set	SCG-21S	418 lbs.	160 lbs.
RCG-18S	310 lbs.	240 lbs.	6'6"H x 18'6"W x 2'B x 6'D	\$3,279 set	SCG-18S	362 lbs.	240 lbs.
RCG-12S	264 lbs.	240 lbs.	6'6"H x 12'W x 2'B x 6'D	\$2,859 set	SCG-12S	306 lbs.	240 lbs.
RCG-9S	218 lbs.		4'6"H x 9'W x 2'B x 5'D	\$2,369 set	SCG-9S	250 lbs.	
RCG-6S	198 lbs.		4'6"H x 6'W x 2'B x 5'D	\$2,049 set	SCG-6S	224 lbs.	



Move your Club Goals around your field with ease with our optional wheel kit.



NOVA Wheel Kit

Includes 4 large 10" "no flat" tires. Easily attaches to any NOVA base. (SGP-600, and NOVA Club round and square). Wheel engagement is quick and easy. One kit fits 2 goals.

NSGWK 45 lbs. **\$449 kit**



NSGWK



NEW VOLLEYBALL SOCCER FOOTBALL LACROSSE BASEBALL FIELD MARKING SCOREBOARD BASKETBALL GYMNASIUM FIELD SEATING BALL STORAGE PHYS. ED. TENNIS

CLASSIC Club Goal

Natural finish, all aluminum, portable goal offers a 3 piece construction including 2 all welded side frames with patented counterweight and crossbar. Goal frame is 4" x 2" with 2" O.D. backstays. 2" O.D. galvanized steel rear ground crossbar is included on the three larger sizes. All Economical Classic Club goal packages come complete with one pair of goals, one pair of 4" square mesh white nets, hook-and-loop net straps and a set of eight Auger style anchors. For additional styles of anchors, see (pages 31-32). Optional wheel kits are available separately (below).

Complete Set Includes:



Square Club Goal with patented counterweight



Nets - 4" sq. mesh, white



Rear Ground Crossbars 24' - 21' & 18'6" goals



Hook-and-loop net attachment



Auger style Anchors



All welded side frames for increased durability!

SAFETY FEATURE

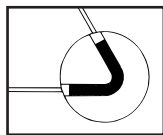

Patented built-in Counter-weight

The Classic Club Goals are counter-weighted for additional safety and stability. Solid steel bars are hidden inside the backstays to help prevent accidental tip over.

Item	Size	Weight	Price	Counter Weight
CSG-824S	8'H x 24'W x 4'B x 9'D	395 lbs.	\$2,398 set	140 lbs.
CSG-721S	7'H x 21'W x 3'B x 8'D	345 lbs.	\$2,198 set	160 lbs.
CSG-618S	6'6"H x 18'6"W x 2'B x 6'D	299 lbs.	\$1,998 set	240 lbs.
CSG-612S	6'6"H x 12'W x 2'B x 6'D	188 lbs.	\$1,698 set	240 lbs.
CSG-409S	4'6"H x 9'W x 2'B x 5'D	157 lbs.	\$1,498 set	
CSG-406S	4'6"H x 6'W x 2'B x 5'D	145 lbs.	\$1,398 set	

Which size goal does your Program need?

Age Group	Recommended Goal Size	Maximum Ball Size	Minimum Players/Team
U-13	8' x 24'	5	11 vs 11
U-12	Up to 8' x 24'	5	11 vs 11
U-11	Up to 8' x 24'	4	9 vs 9
U-10	Up to 8' x 24'	4	8 vs 8
U-9	Up to 6.5' x 18.5'	4	6 vs 6
U-8	Up to 6.5' x 12'	3	4 vs 4
U-6 / U-7	Up to 4' x 6'	3	3 vs 3



CSGWK

Classic Wheel Kit

Includes 4 large 10" "no flat" tires with fasteners for attachment to goals, SGP-760, SGP-400 and SGP-100. Can also be used with Classic Club Goals fitted with optional rear ground crossbars. One kit fits 2 goals.

CSGWK

45 lbs.

\$449 kit

**Deluxe Official Futsal Goal**

Powder coated, portable goal offers an extruded aluminum frame featuring our exclusive flush mount Easy Track™ net attachment system. Official size 6' 7" H (2m) x 9' 10" W (3m) meets specifications. Includes non-marring floor protectors, 4" sq. mesh net and Easy Clips™.

FSG67910 240 lbs. **\$2,598 pair**

**Futsal Goal Replacement Net**

FSG67910N 8 lbs. **\$159 pair**

Futsal Goal Wheel Kit

FSGWK 40 lbs. **\$449 pair**



**FSGWK
Wheel Kit**



**Jaypro
XCLUSIVE
Easy Track™
Net Clips**

Quick Set Up Goal

Convenient for any league or backyard use as it sets up in minutes. Goal size 8' H, adjusts to 8', 16' or 24' wide. 2" O.D. aluminum frame assembles quickly with quick release & push pins. Includes goal, net, 6 net pegs, indoor floor pads, and carry bag.

SEYL-824 52 lbs. **\$795 each**

Replacement Net

SEYL-24NHP 7 lbs. **\$119 each**



**ALL SURFACE
FRIENDLY**



Complete Set includes: goal, net, net pegs, anti-skid pads and carry bag!



SMG-8HP

On the grass or in the gym.

Rugged Play Goal

Heavy duty steel goal for precision shooting drills or short-sided games. Great for youth leagues or the back yard! 4'H x 8'W x 4'D - great for 4 vs. 4 play! Sturdy 2" O.D. galvanized steel construction with powder coated finish. **Includes Net** - 4" square, 2.5 mm orange polyethylene. For outdoor and indoor use.

SMG-8HP Goal 50 lbs. **\$229 each**

SMG-8NHP Replacement Net 1 lb. **\$39 each**

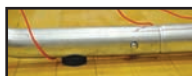

Quick push-pins make break-down easy for transporting goal. Includes rubber feet to protect gym floor!

**ALL SURFACE
FRIENDLY**

**48 HOUR
QUICK SHIP**

Two Goals In One!

4' x 6' Goal -OR- Flip to 3' x 6' Goal

Two-For Youth Goal

Ideal youth goal - two sizes in one with easy push pin assembly. Powder coated 1.5" O.D. aluminum frame with black 1-3/4" sq. mesh net and hook and loop net attachments.

**48 HOUR
QUICK SHIP**

MPG-46 Goal 23 lbs. **\$249 each**

MPG-46N Replacement Net 2 lbs. **\$39 each**



MPG-46

Quick push-pins make break-down easy for transporting goal.

Indoor/Outdoor Folding Steel Goal

Uniquely designed goal provides outstanding performance and versatility. Perfect for competitive indoor play and an ideal outdoor training and youth goal! 7'H x 12'W x 4'D. 2" O.D. zinc undercoat with powder coated steel construction provides excellent durability. 1-5/16" O.D. zinc undercoated steel backstays fold without removing net. Non-marking floor protectors included for indoor use. See pages 31-32 for ground anchors for outdoor use. Includes 4" sq. mesh net with hook and loop net straps to eliminate lacing.

Best Seller!

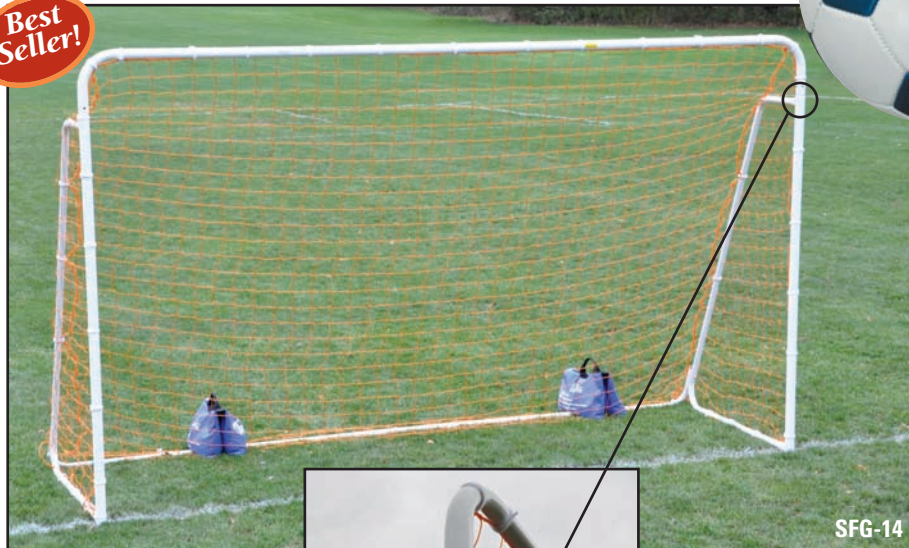

SFG-14

SFG-14 161 lbs. **\$749 pair**



Replacement Net

SFG-14N 4 lbs. **\$129 pair**

ALL SURFACE FRIENDLY

48 HOUR QUICK SHIP



Folds for portability and storage!



2" O.D. Steel Pipe is both strong and durable for Youth play!

See pages 31-32 for ground anchors for outdoor use



All portable, short sided goals fold for easy transport and storage.

All welded side frames for increased durability!

Included rear ground crossbars add strength and stability!



PSS-608

Portable, Short Sided Soccer Goals

1-5/16" O.D. galvanized powder-coated white steel frame. Welded side frames and rear ground crossbars for added strength and stability. Snap pins to lock frame in place for added safety. Includes ground anchors, nets, 2.5 mm, twisted, 4" sq. mesh and net ties. Folds for easy transportation and storage.

Great for 4 vs 4 play

PSS-612 6'H x 12'W x 31"D

Powder Coated White Goal 63 lbs. **\$289 each**

PSS-612N

Replacement Net 3 lbs. **\$46 each**

PSS-608 6'H x 8'W x 31"D

Powder Coated White Goal 60 lbs. **\$269 each**

PSS-608N

Replacement Net 2 lbs. **\$44 each**

PSS-510 5'H x 10'W x 34"D

Powder Coated White Goal 57 lbs. **\$249 each**

PSS-510N

Replacement Net 2 lbs. **\$42 each**

Great for 3 vs 3 play

PSS-406 4'H x 6'W x 24"D

Powder Coated White Goal 40 lbs. **\$229 each**

PSS-406N

Replacement Net 2 lbs. **\$38 each**

ALL SURFACE FRIENDLY

48 HOUR QUICK SHIP

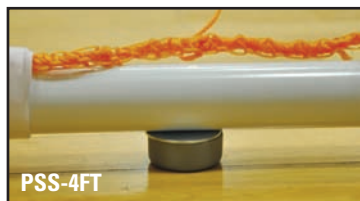

PSS-4FT

Optional Floor Protector Kit

Use your PSS goals indoors! Optional floor protector kit ensures that your gym floors will not get scratched! Self-threading screws with 4 rubber feet.

PSS-4FT 2 lbs. **\$29 kit**

Priced in Pairs



SGPU4830R	Jaypro Pop-Up Goals - Small Red	4 lbs.	\$79 pair
SGPU7240B	Jaypro Pop-Up Goals - Large Blue	6 lbs.	\$99 pair

Use Outdoor
or Indoor!

STG-23	Goal - 2'H x 3'W	20 lbs.	\$108 each
STG-23N	Replacement Net	3 lbs.	\$54 each
STG-34	Goal - 3'H x 4'W	25 lbs.	\$169 each
STG-34N	Replacement Net	4 lbs.	\$64 each
STG-46	Goal - 4'H x 6'W	39 lbs.	\$229 each
STG-46N	Replacement Net	5 lbs.	\$82 each

Roll-A-Goal

This attractive versatile goal is great for short sided games and developing shooting skills.

Available in three sizes: small (2'H x 3'W), medium (3'H x 4'W) or large (4'H x 6'W) - great for 3 vs 3 play. 1-5/16" O.D. steel frame folds flat for compact storage and includes front wheels for easy transporting. Includes durable knotless nylon net with vinyl sleeves that attach with hook and loop. No lacing required! For outdoor and indoor use.

**ALL SURFACE
FRIENDLY**

*Non marking wheels
transport goal
quickly and easily!*

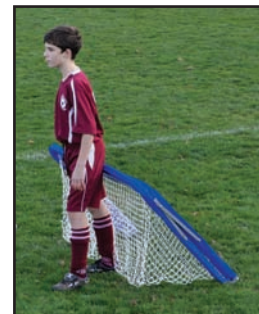

ASR33BK

Folds flat for easy transportability perfect for the backyard, driveway or the soccer field!

**Adjustable Soccer Rebounder**

A great training device for developing players, especially goalies! Available size: 40"H x 40"W rebound surface. 1.25" O.D. heavy duty, powder coated steel black frame and support base. Three adjustable playback angles. White mesh net with 1/8" black cord.

ASR33BK	21 lbs.	\$249 each
----------------	---------	-------------------





Available in Two Sizes!

48 HOUR QUICK SHIP

STG-824

STG-718

Carry Bag Included with both Training Goals and Rebounders!

Portable Training Goal

This **light weight, stable** goal is perfect for European style training. Available in two sizes: Large (8'H x 24'W) and Medium (7-1/2'H x 18'W). 2" O.D. Heavy wall aluminum frame with white powder coated finish. Includes 4" square mesh nylon net. Stabilizing ground base plate included. Includes a carry bag.

STG-718	Medium Training Goal	44 lbs.	\$599 each
STG-718N	Medium Replacement Net	4 lbs.	\$69 each
STG-824	Large Training Goal	62 lbs.	\$669 each
STG-824N	Large Replacement Net	5 lbs.	\$99 each



STGRB824

Available in Two Sizes!

Stable anchored base

Heavy-duty wall construction for a long lasting rebounder!



SMALL
78" L x 11" dia.

MEDIUM
100" L x 13" dia.

LARGE
105" L x 15" dia.

Replacement Equipment Carry Bag

The bag makes the goal or rebounder easy to transport and is convenient for storage. Heavy duty Cordura black bag and reinforced zipper. Includes carry straps and handles on each end. Large bag will hold our SEYL-824 goal. Medium bag will hold the above training goals and rebounders. Small bag will hold the MPG-46 goal and miscellaneous items.

ECB-LG	Large Bag	6 lbs.	\$79 each
ECB-MD	Medium Bag	5 lbs.	\$69 each
ECB-SM	Small Bag	4 lbs.	\$59 each

48 HOUR QUICK SHIP

Stable Anchored Base!

Anchoring to the ground is much easier! The powder coated white ground base assembly lies flat on the ground. The ground stake is inserted through the middle of the base to anchor it to the ground. Then the upright is placed over a sleeve on the base assembly, resulting in a stable goal with no visible anchor to cause a tripping hazard!

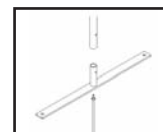

Soccer Rebounder

Same construction as above training goals but also includes additional bottom crossbar with extra anchored base, white 1-1/2" sq. mesh net with 1/8" cord and bungee net attachments. Includes a carry bag.

STGRB718	Medium Rebounder	48 lbs.	\$669 each
RB718N	Medium Rebound Net	5 lbs.	\$89 each
STGRB824	Large Rebounder	67 lbs.	\$795 each
RB824N	Large Rebound Net	6 lbs.	\$109 each



Bungees

Replace old and worn bungees. 6" long. Comes in bags of 30. Two (2) bags are required for the STGRB718 Medium Rebounder and three (3) bags are required for the STGRB824 Large Rebounder.

STGRB718B	6" Bungees	2 lbs.	\$29 bag
------------------	------------	--------	-----------------



Easy Track™ Net Clips
fit securely and flush in
our goals. Check out
our **NEW Colors**
on page 32!

Net Pegs
Prevents ball
from passing
under the net.



NP-25 3 lbs.

\$42 set of 25

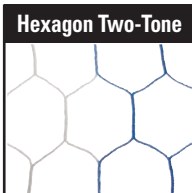

Hexagon Two-Tone

Offering
the Two-Tone
Hexagon Net
in four colors!

48 HOUR
QUICK SHIP

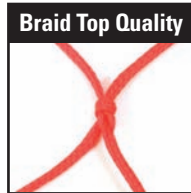

Braid Top Quality

Choose from
economical
"twist" nets or the
more durable
"braided" nets

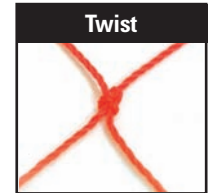

Twist

	Model	Size	Mesh	Twine	Color	Weight	Price
OFFICIAL	SND-8*	8' x 24' x 4' x 10'	5.5" sq.	4mm Braid		White	25 lbs. \$229 pr
	SND-7*	8' x 24' x 4' x 10'	5.5" sq.	4mm Braid		Orange	25 lbs. \$229 pr
	SN-40B*	8' x 24' x 4' x 10'	5.5" sq.	4mm Braid		Blue	25 lbs. \$229 pr
	SN-40R*	8' x 24' x 4' x 10'	5.5" sq.	4mm Braid		Red	25 lbs. \$229 pr
	SN-40Y*	8' x 24' x 4' x 10'	5.5" sq.	4mm Braid		Yellow	25 lbs. \$229 pr
	SN-HTTP-W*	8' x 24' x 4' x 10'	5.5" hex	5mm Braid		White	30 lbs. \$329 pr
	SGP-550N*	8' x 24' x 6' x 6' BOX	5.5" hex	5mm Braid		White	25 lbs. \$329 pr
	SN-6BLUW*	8' x 24' x 6' x 6' BOX	5.5" hex	5mm Braid		White/Blue	25 lbs. \$299 pr
	SN-6GRNW*	8' x 24' x 6' x 6' BOX	5.5" hex	5mm Braid		White/Green	25 lbs. \$299 pr
	SN-6REDW*	8' x 24' x 6' x 6' BOX	5.5" hex	5mm Braid		White/Red	25 lbs. \$299 pr
	SN-6BLKW*	8' x 24' x 6' x 6' BOX	5.5" hex	5mm Braid		White/Black	25 lbs. \$299 pr
	SN-2BLUW*	8' x 24' x 4' x 10'	5.5" hex	5mm Braid		White/Blue	30 lbs. \$299 pr
	SN-2GRNW*	8' x 24' x 4' x 10'	5.5" hex	5mm Braid		White/Green	30 lbs. \$299 pr
SN-2REDW*	8' x 24' x 4' x 10'	5.5" hex	5mm Braid		White/Red	30 lbs. \$299 pr	
SN-2BLKW*	8' x 24' x 4' x 10'	5.5" hex	5mm Braid		White/Black	30 lbs. \$299 pr	
CLUB	SEYL-24NHP*	8' x 24' x 0' x 8'	5.5" sq.	2.5mm Twist		Orange	14 lbs. \$119 ea
	SCN-24*	8' x 24' x 4' x 10'	4" sq.	3mm Twist		White	20 lbs. \$179 pr
	SCN-21	7' x 21' x 3' x 8'	4" sq.	3mm Twist		White	11 lbs. \$169 pr
	SCN-18	6-1/2' x 18-1/2' x 2' x 6'	4" sq.	3mm Twist		White	10 lbs. \$149 pr
	SCN-12	6-1/2' x 12' x 2' x 6'	4" sq.	3mm Twist		White	8 lbs. \$139 pr
	SCN-9	4-1/2' x 9' x 2' x 5'	4" sq.	3mm Twist		White	6 lbs. \$119 pr
	SCN-6	4-1/2' x 6' x 2' x 5'	4" sq.	3mm Twist		White	6 lbs. \$109 pr
YOUTH	SFG-14N	7' x 12' x 1' x 4'	4" sq.	2.5mm Twist		Orange	6 lbs. \$129 pr
	SMG-8NHP	4' x 8' x 0' x 4'	4" sq.	2.5mm Twist		Orange	5 lbs. \$39 ea
	PSS-612N	6' x 12' x 0' x 4'	4" sq.	2.5 mm Twist		Orange	3 lbs. \$46 ea
	PSS-608N	6' x 8' x 0' x 4'	4" sq.	2.5mm Twist		Orange	2 lbs. \$44 ea
	PSS-510N	5' x 10' x 0' x 4'	4" sq.	2.5 mm Twist		Orange	2 lbs. \$42 ea
PSS-406N	4' x 6' x 0' x 3'	4" sq.	2.5mm Twist		Orange	2 lbs. \$38 ea	

* Official Size Nets



World Cup Anchor



ALL SURFACE FRIENDLY

Stackable design for easy storage



Keep your soccer goals safe from tipping and up to code with weight requirements



Ideal where in-ground anchoring devices are not appropriate. Tank style anchor has a 4-3/8"W x 3-1/4"H opening designed to fit over any round or flat rear crossbar. Hard plastic shell will not crack when filled in the field with 50 lbs of concrete, 39 lbs of sand or 24 lbs of water. Large carry handle and stackable design allow for convenient storage. Overall size 8-1/2"H x 12"W. Comes in bright yellow for visibility and safety. Please check the ASTM counterweight requirements for your specific goal when ordering to ensure proper anchoring.

- SGA-50** Set of 4 12 lbs. **\$289 set**
- SGA-51** Single 3 lbs. **\$79 each**

NEW

Multi-Use Soccer Cart
Heavy duty utility cart especially designed for hauling soccer field equipment. Easily transport your awkward and often heavy equipment; such as goal anchors, corner flags, balls and any other equipment needed for games and practices. Measures 26"W x 51"L, with fold down sides for easy loading. *Pull by hand or tow by ATV or utility tractor.* Travel on (4) 13"x 5"W pneumatic turf tires, which are rated to hold up to 350 lbs. each. Holds up to 16 NOVA World Cup anchors.

Easily carry over 800 lbs. of equipment!

SGA-CART **\$649 each**

Counterweight Requirements for Soccer Goals

All soccer goals that are not permanently anchored must have a certain amount of counterweight, even when the goals have met all ASTM requirements. The chart below is the counterweight requirements for Jaypro's soccer goals.

	Item #	Counterweight required per goal	NOVA World Cup Anchors or Sand Bags required per goal
8' x 24' Official	SGP-600FS	140 lbs.	3 per goal
	SGP-600	140 lbs.	3 per goal
	SGP-400	160 lbs.	4 per goal
	SGP-760	140 lbs.	3 per goal
	SGP-100	170 lbs.	4 per goal
8' x 24' Club	RCG-24S	150 lbs.	3 per goal
	SCG-24S	140 lbs.	3 per goal
	CSG-824S	140 lbs.	3 per goal
7' x 21' Jr	SGP-100JR	190 lbs.	4 per goal
7' x 21' Club	RCG-21S	170 lbs.	4 per goal
	SCG-21S	160 lbs.	4 per goal
	CSG-721S	160 lbs.	4 per goal
	RCG-18S	240 lbs.	5 per goal
6.5' x 18.5' Club	SCG-18S	240 lbs.	5 per goal
	CSG-618S	240 lbs.	5 per goal
	RCG-12S	240 lbs.	5 per goal
6.5' x 12' Club	SCG-12S	240 lbs.	5 per goal
	CSG-612S	240 lbs.	5 per goal

Sand Bag Anchor
Ideal where in-ground anchoring devices are not appropriate. Fill in the field with 50 lbs. of dry sand. Choose from steel carry handle (SWB-451) or nylon strap design (SWB-451W). Also available in pink. (May come in different colors)



Sand Bag with Steel Handle

SWB-451 2 lbs. **\$58 each**

SWB-454 8 lbs. **\$212 set of 4**

Pink Bag with Steel Handle

SWB-451PK 2 lbs. **\$58 each**

SWB-454PK 8 lbs. **\$212 set of 4**



ALL SURFACE FRIENDLY

Sand Bag with Nylon Strap

SWB-451W 2 lbs. **\$42 each**

SWB-454W 8 lbs. **\$149 set of 4**

Pink Bag with Nylon Strap

SWB-451WP 2 lbs. **\$42 each**

SWB-454WP 8 lbs. **\$149 set of 4**



NEW VOLLEYBALL SOCCER FOOTBALL LACROSSE BASEBALL FIELD MARKING SCOREBOARD BASKETBALL GYMNASIUM FIELD SEATING BALL STORAGE PHYS. ED. TENNIS

NEW VOLLEYBALL SOCCER FOOTBALL LACROSSE BASEBALL FIELD MARKING SCOREBOARD BASKETBALL GYMNASIUM FIELD SEATING BALL STORAGE PHYS. ED. TENNIS

Soil: Loose and Sandy

Soil: Firm and Compressed

Soil: Firm and Tightly Compacted

217RP

48 HOUR QUICK SHIP

Auger
18" steel auger with steel wire lanyard.

SAS-95 5 lbs.

\$69 set of 4



SAS-95

J-Hook Stake
Rugged 18" J-style steel stake with steel wire lanyard.

48 HOUR QUICK SHIP

SGA-91 16 lbs.

\$99 set of 4



SGA-91

Spike
18" long 3/4" galvanized steel stake with steel wire lanyard.

48 HOUR QUICK SHIP

SS-18 12 lbs.

\$108 set of 4



SS-18

48 HOUR QUICK SHIP

Youth Goal Anchor
3/8" diameter, 15.5" long. **Not appropriate for official goals.**

217RP 2 lbs.

\$35 set of 4



Weight Anchor
40 pound anchor weights for indoor or outdoor surface anchoring.

48 HOUR QUICK SHIP

SGA-40

43 lbs.

\$159 each

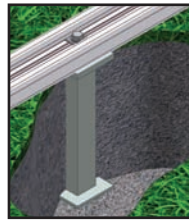

In-Ground Anchor

In-ground goal anchors provide the surest means of anchoring - will neither pull out nor slide off the base frame. Securely anchors any portable NOVA goal, or existing goal with minor modification. Set includes two anchors for one goal.

48 HOUR QUICK SHIP

SGA-60

13 lbs.

\$199 set of 2



D1315

Soccer Ball Bag
All-purpose nylon mesh ball and utility bag. Easy to use cord clasp. Size: 24" x 36"

D1315 1 lb.

\$6 each

48 HOUR QUICK SHIP

Ball Storage Bag
Heavy duty mesh and Cordura ball bag. Draw string for closure and two straps to carry like a backpack. Holds up to 17 balls. 20" x 35" black.

BLBG-20 2 lbs.

\$39 each



BLBG-20

Soccer Goal Post Pads
Unique shock absorbent pad provides extra margin of safety! 1" thick, 6' high, made from closed cell waterproof and cut resistant white foam. Firm surface maintains golf like rebound characteristics. Complies with NFHS rule 1-4-1. Easy clip attachment. Set of 2 covers one goal.

48 HOUR QUICK SHIP

Used on all 4" square, 4" round and 2x4" rectangular goals. Jaypro's SGP, SCG and CSG goals.

SPP-4 10 lbs. \$389 set

Used on all 3" round goals. Jaypro's RCG goals.

SPP-3 10 lbs. \$299 set



SPP-4

Easy Clips™
These rigid plastic clips fit securely into Easy Track™ so net won't slip. Bag of 100 clips. One bag includes enough clips for one pair of goals. **Colors available: white, pink, black, red and blue.**

EC-824	EC-824	white	1 lb.	\$82 bag
EC-824PK	EC-824PK	pink	1 lb.	\$82 bag
EC-824BK	EC-824BK	black	1 lb.	\$82 bag
EC-824RD	EC-824RD	red	1 lb.	\$82 bag
EC-824BL	EC-824BL	blue	1 lb.	\$82 bag

NEW NEW NEW NEW



Net Clips
Exclusive design, treated steel "money clip". For use with existing pre-drilled 5/16" diameter holes. 70 clips per kit. Includes plastic retainers. Enough for one pair of 8' x 24' goals.

SNT-180 2 lbs. \$72 kit

Same as SNT-180, except with self-drilling screws for aluminum goals. Space at 14".

SNT-200 2 lbs. \$67 kit

Hook-and-Loop Closure
Custom cut your own straps. White hook-and-loop closure is 1-1/2" wide x 75' long. Enough to fit one pair of official goals.



VNS-25

VNS-25 6 lbs. \$79 each

Hook-and-Loop Closure Strips
Convenient hook-and-loop closure tape net strips secure net without lacing.

Fits up to 2" O.D. tubing
SINT-20 2 lbs. \$34 kit of 20

Fits 4" x 2" or 3" O.D. tubing - Kits will fit two (2) Classic Club Goals.

Fits 4'6"x6', 4'6"x9' & 6'6"x12' Club goals
SINT-40 2 lbs. \$44 kit of 40

Fits 6'6"x18'6", 7'x21' & 8'x24' Club goals
SINT-60 2 lbs. \$54 kit of 60



SINT-20





Disk Cone

Lightweight markers for practice and drills. 2-1/4" H and 7-5/8" diameter base. Easily carried, won't tip over, highly visible. Comes in 4 colors.

D272BL	blue	1 lb.	\$0.82 each
D272OR	orange	1 lb.	\$0.82 each
D272RD	red	1 lb.	\$0.82 each
D272YW	neon yellow	1 lb.	\$0.82 each

Disk Cone

Colored cones are now available in quantities of 100 per set.

D272BL-100	blue	15 lbs.	\$72 set
D272OR-100	orange	15 lbs.	\$72 set
D272RD-100	red	15 lbs.	\$72 set
D272YW-100	neon yellow	15 lbs.	\$72 set



Disk Cone Carrier

Durable white vinyl-coated 5mm steel frame. Size: 7" dia. x 12"H. Holds up to 200 disk cones (not included).

DCC7	1 lb.	\$5 each
-------------	-------	-----------------

Package & SAVE!



Disk Package

Disk cone carrier (DCC7) and 30 cones (D272) of each color, blue, orange, red and neon yellow. 120 total cones!

DCPKG	20 lbs.	\$84 package
--------------	---------	---------------------

Training Cones

Bright orange, solid plastic stackable cones with perimeter base. Available in two sizes.



D171	9"H cone	1 lb.	\$1.79 each
D175	12"H cone	1.5 lbs.	\$3.29 each



Deluxe Corner Flags

60" high, 3/4" thick PVC pole with heavy-duty base and square red and white flag. Each set includes four flags.

DCF-251	8 lbs.	\$84 set
----------------	--------	-----------------

Deluxe Training Flags

Spring loaded base ideal for training drills and safety corner flags. Each set includes four flags.

DCF-255	8 lbs.	\$94 set
----------------	--------	-----------------



Field ID Markers

14" x 14" vinyl markers with corner grommets to put on the back of the net of each goal. Specify color and numbers when ordering.

FIM-14	1 lb.	\$19 each
---------------	-------	------------------



Cone Cart

Durable 1" dia. steel powder coated blue frame. Includes large 8" diameter wheels for use indoor and outdoors. Rubber stopper protects gym floors. Will hold up to 130 standard 12" cones.

CNCART	22 lbs.	\$159 each
---------------	---------	-------------------



Corner Flags

Can be used on turf, indoor or outdoors, official 5' high, 1" diameter PVC poles. Set includes 4 poles, 4 flags and 4 black rubber bases.

RBF-4	50 lbs.	\$220 set
--------------	---------	------------------



Flag Base Bag

Transport the rubber bases in this vinyl carry bag. 12"W x 12"D x 14"H. Each bag holds (4) bases.

RBF-BASE	3 lbs.	\$25 each
-----------------	--------	------------------

Wet and Dry Field Marking products and Line Layout Systems are located on pages 67-69

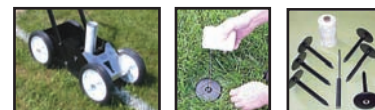



SR-12

Speed Rings

Twelve rings per set (4 of each: red, blue and yellow), 18" diameter x 3/4" wide flat rings.

SR-12

3 lbs.

\$29 set



SCSPCHT

Speed Chute

Ultimate training device for improving speed, strength and resistance. Provides up to 15 lbs. of resistance, includes adjustable strap with hook and loop closure.

SCSPCHT

1 lb.

\$39 each



SL-20

Speed Ladder

20'L x 20"W with (24) adjustable flat rungs. Carrier handle included.

SL-20

6 lbs.

\$38 each



SARC-12

Passing Arc

Constructed of yellow PVC. Spikes for easy insertion in ground. Size: 20" x 12". Set of 12. Includes carry bag.

SARC-12

9 lbs.

\$79 set



RBCS-6

Coaching Sticks

Can be used on turf, indoor or outdoors, official 5' high, 1" diameter PVC poles. Set includes 6 poles and 6 black rubber bases.

RBCS-6

70 lbs.

\$260 set

ALL SURFACE FRIENDLY**Flag Base Bag**

Transport the rubber bases in this vinyl carry bag. 12"W x 12"D x 14"H. Holds (4) bases. (2 bags required per set)

RBF-BASE

3 lbs.

\$25 each



SCSPDKIT

Speed Agility Kit

Kit includes: Fast foot ladder 4mtr (2 pieces), Hurdle 6", 9" & 12" (2 of ea), Speed chute, Speed harness, Speed resistor, Reaction ball senior, Evasion belt, Ten Saucer cones and a carry bag.

SCSPDKIT

17 lbs.

\$179 set

NEW**Strike Attack Soccer Machine**

Battery powered machine provides reliable service on any soccer field or playing surface. A realistic curve and bend of the ball can be consistently delivered and easily controlled. Balls can be delivered at speeds up to 75 mph and distances of 70 yards or more. The type of spin, height and direction desired can be locked into place to ensure precise repetition focused on your specific training objectives.

SASM-1

250 lbs.

\$4,199 each

**STRIKE ATTACK**



Call Customer Service for Details on Pricing and Options.



Color Choices: Gray, Navy Blue, Royal Blue, Red, Black, Maroon or Green

Soccer Shelter

Features include: 17'W x 6' 4"H x 5'D. Powder coated steel frame. Removable top for quick and easy (dis)assembly. Includes 4 auger stakes for grass or 4 sand bags (filled in the field) for turf anchoring (specify when ordering). Wheel Kit. **Available Options:** Optional Team Name/Logo. Zippered sides to improve ventilation and wind passage. Additional sizes and styles available. See pages 106-107 for optional matching color player bench choices. Does not ship from Jaypro's CT warehouse. Call for Options, Pricing and Freight Quote.

Portable Team Benches

Convenient, collapsible benches fold in seconds, include carry bag and end gear pockets. Weight capacity per seat is 250 lbs. Comes in two sizes: 3 person and 6 person.



TMBNCH6

Gear pocket located on the end of the bench.

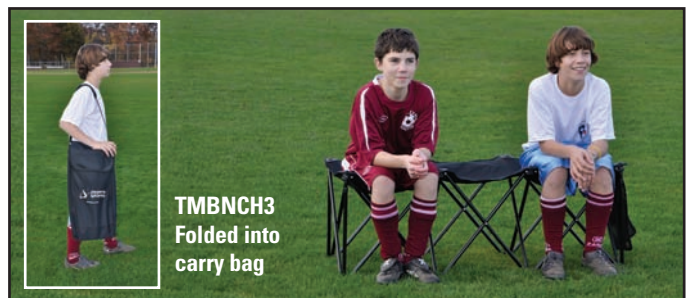

TMBNCH3
Folded into
carry bag

TMBNCH6 6 person 104"x 19"x 17" 19 lbs. **\$149 each**

TMBNCH3 3 person 53"x 19"x 17" 13 lbs. **\$79 each**



FLD-B5



Field-To-Go Team Bench

Five person bench with end cup holders folds compactly into a 6" x 21" x 32" carry bag. Each seat supports up to 250 lbs.

FLD-B5 27 lbs. **\$129 each**



CSTOOL

DCSTOOLWB

Coaches Stools

Foldable coaches stools with hook-and-loop carry strap. Weight capacity 275 lbs.

CSTOOL No Back
18"x 11"x 11" 2 lbs. **\$28 each**

DCSTOOLWB Back
30"x 15.5"x 13" 3 lbs. **\$39 each**

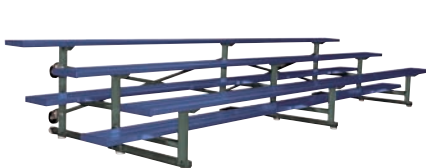

See pages 100-107 for additional player and spectator seating.

ALL ALUMINUM! Removable European Backstays



Removable Standard Backstays



Football Goal



4" O.D. Crossbars, strong gussets for a clean look!

Deluxe Official Soccer/Football Goal

This durable combination of official soccer and football goals is an excellent addition to any multi-purpose athletic facility. 8' x 24' x 10' x 4" (soccer goal dimensions). Main soccer uprights and crossbars are 4" O.D. round extruded aluminum featuring our Easy Track™ net attachment system. Reinforced corners for extra strength and durability. Removable soccer backstays are 2" O.D. 10' H top football uprights are 2-3/8" aluminum. Tough powder coated white finish. Meets NFHS and NCAA specifications. Designed for permanent or semi-permanent installation. Nets, page 30, post padding, page 41 and ground sleeves, below, available separately.

FBSC-240 Goal w/Standard Backstays 500 lbs. **\$4,295 pair**

FBSC-240EB Goal w/European Backstays 470 lbs. **\$4,395 pair**



← Easy Track™ net attachment system!



Easy Clips™ are included!

Aluminum Ground Sleeves

Set of 4 aluminum ground sleeves with locking caps for semi-permanent installation.

SGP-445G 28 lbs. **\$479 set**



FBSC-120
Base Goal with no Backstays



FBSC-120
Base Goal for Football



FBSC-120FBS
Full Backstays



FBSC-120EBS
European Backstays

Official Soccer/Football Goal

For shared football and soccer fields. Meets high school regulations for competition football and soccer. Soccer goal dimensions are 8' x 24', and football crossbar is 10' high. Football uprights can be installed at high school (23' 4") or collegiate (18' 6") widths, or removed for soccer play. Goal support uprights are constructed of 2" x 4" 14 gauge steel tubing. Top football uprights are 2" square steel tube, extending 10' above the crossbar. Finish is tough durable white powder coat over zinc rich primer. Includes "money clip" style net attachment. Permanent or semi-permanent installation, using optional ground sleeves (see below). Nets (page 30) and backstays purchased separately.

Base Combo Goal with no Backstays

Use SEYL-24NHP net with no top depth, 8' x 24' x 0' x 8' (ordered separately on page 30).

FBSC-120 650 lbs. **\$2,795 pair** 

Standard Backstay Kit

Set of 4 removable full soccer backstays made from 1.66" O.D. galvanized steel tubing. Use with standard official size net, 8' x 24' x 4' x 10' (ordered separately on page 30).

FBSC-120FBS 140 lbs. **\$629 set**

European Backstay Kit

Set of 4 removable European backstays made from 1.66" O.D. aluminum tubing, with 4' depth. Use with standard official size net, 8' x 24' x 4' x 10' (ordered separately on page 30).

FBSC-120EBS 45 lbs. **\$599 set**

Ground Sleeves

Optional 24" ground sleeves for semi-permanent installation. Includes 4 sleeves and locking caps.

SGP-722G 15 lbs. **\$465 set**



FOOTBALL/SOCCER COMBO

Portable Practice Football/Soccer Combo Goal - High School

Soccer shooting area 8'H x 24"W. High school football crossbar 23' 4"W. Constructed of 2" O.D. galvanized steel. Four easy roll wheels allow complete mobility. Light but stable. Great for multipurpose or practice fields. Net (below) and Wind Streamers (page 41) sold separately.

PCG-800 400 lbs. **\$1,995 each**

Portable Combo Goal Net

5.5" sq. mesh, 2.5 mm orange polyethylene net.

SEYL-24NHP 7 lbs. **\$119 each**

PNT-1 Powder Coat **\$100 each**



Easy Roll Wheels

PCG-800 shown with SEYL-24NHP

FOOTBALL ONLY

Portable Practice Football Goal - High School

20'H x 23'4"W

PPG-4HS 375 lbs. **\$1,795 each**

Portable Practice Football Goal - Collegiate

20'H x 18'6"W

PPG-4C 375 lbs. **\$1,795 each**

H-Frame Football Goal Post

H-style goal post meets official NFHS specifications. Constructed with heavy wall 4" O.D. heavy wall Aluminum tubing. Measures 23'-4"W x 20'H. Uprights extend 10' above crossbar. **Goal is powder coated white.** Designed for permanent installation.

HFGP-3 400 lbs. **\$1,995 pair**



HFGP-3

Official Rugby Goal

Official size Rugby goal measures 18'-4"W (5.6m) x 32'H (9.8m). Uprights extend 22' above crossbar. Uprights made with 4" O.D. Sch 40 aluminum tubing. Crossbar is 4" O.D. 8 gauge aluminum tubing. Tough powder coated white finish. Designed for permanent installation.

RGP-3 580 lbs. **\$3,795 pair**

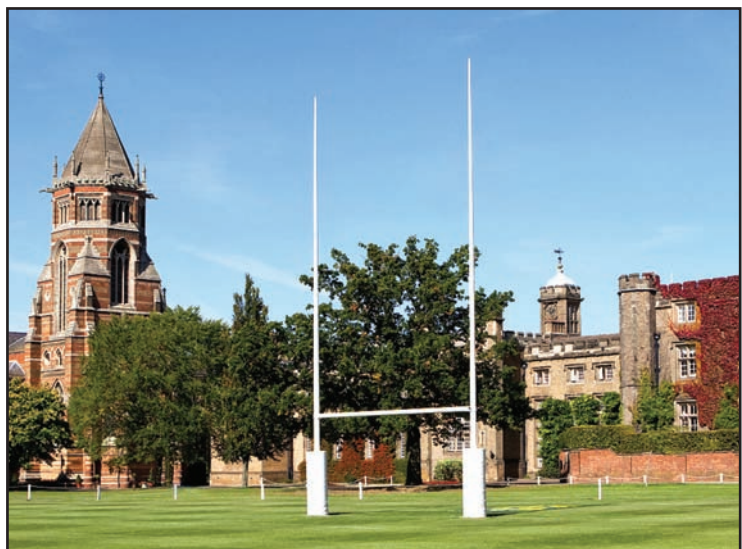



Fully Adjustable in 2 Directions ensuring the crossbar and uprights are level and plumb!

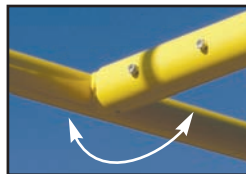
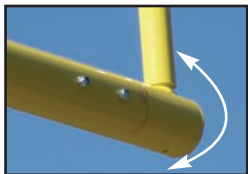

Economical Steel Football Goal Post

- Zinc and powder coated steel goosenecks available in 4-1/2" with 5' offset OR 5-9/16" with 6' offset
- 20' high 2-3/8" top aluminum uprights
- Permanent or adjustable leveling plate installation
- Ground sleeves available separately (below) for semi-permanent installation
- Meets NFHS & NCAA specifications
- **Collegiate goal posts also available, please call or visit our website for details.**
- **See page 41 for goal post accessories**

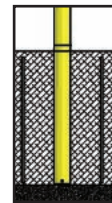

Install directly into concrete or into optional ground sleeve.

-OR-

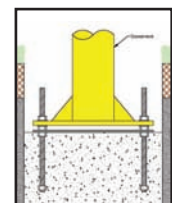

Exclusive adjustable leveling plate allows for correct alignment after installation.

	Offset	Color	Gooseneck	Semi-Permanent/Permanent Item #	Price	Leveling Plate Item #	Price
High School 23' 4" wide	5'	Yellow	4-1/2"	FBGP-620YW	\$4,295 pair	FBGP-600YW	\$5,295 pair
	5'	White	4-1/2"	FBGP-620	\$4,295 pair	FBGP-600	\$5,295 pair
	6'	Yellow	5-9/16"	FBGP-720YW	\$6,295 pair	FBGP-700YW	\$6,995 pair
	6'	White	5-9/16"	FBGP-720	\$6,295 pair	FBGP-700	\$6,995 pair

Collegiate sizes also available - Please call for details and information!

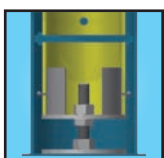

Ground Sleeve with Height Adjuster

Make life easier with this adjustable ground sleeve. Get the perfect alignment with a simple tweek rather than starting from scratch.

FBGPGS-5	4-1/2" dia.	\$895 pair
FBGPGS-6	5-9/16" dia.	\$995 pair

Standard Ground Sleeve

FBSLV5	4-1/2" dia.	\$795 pair
FBSLV6	5-9/16" dia.	\$845 pair

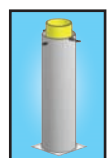

Max-1 All Aluminum Goal Posts



NEW VOLLEYBALL SOCCER FOOTBALL LACROSSE BASEBALL FIELD MARKING SCOREBOARD BASKETBALL GYMNASIUM FIELD SEATING BALL STORAGE PHYS. ED. TENNIS

Max-1 All Aluminum Football Goal Post

- All aluminum construction
- 6-5/8" crossbar and gooseneck available with 6' or 8' offset
- 4" top uprights available in 20' or 30' heights
- Permanent or adjustable leveling plate installation
- 8' offset is perfect for multi-purpose fields and can be used with soccer goal models SGP-600AX, SGP-400, SGP-760 and CSG-824S
- Meets NFHS & NCAA specifications
- **Expandable 18'6" -23'4"** (below) or **Collegiate 18'6"**(online) goal posts also available
- **See page 41 for ground sleeves, access frames, hinge kits and other accessories**



Collegiate sizes available for Max-1 Goal Posts, please call or visit our website for details.



Most impressive goal on the market using 6-5/8" Aluminum material!

	Model	Offset	Uprights	Semi-Permanent/Permanent Item #	Price	Leveling Plate Item #	Price
High School 23' 4" wide	Max-1	6'	20'	FBGP-520	\$7,495 pair	FBGP-420	\$8,995 pair
	Max-1	6'	30'	FBGP-530	\$7,895 pair	FBGP-430	\$9,295 pair
	Max-1	8'	20'	FBGP-820	\$7,695 pair	FBGP-920	\$9,295 pair
	Max-1	8'	30'	FBGP-830	\$8,095 pair	FBGP-930	\$9,595 pair

Expandable Crossbar

Telescoping design allows crossbar width to adjust for official use at 23' 4" (High School) and at 18' 6" (College). Anti-rotation feature holds upright in place allowing one person to adjust. The 8' gooseneck model used with our adjustable rear crossbar soccer goals is ideal for multi-purpose facilities.

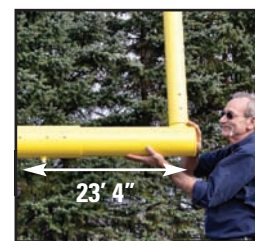
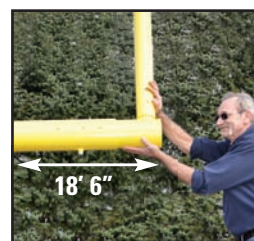

	Model	Offset	Uprights	Semi-Permanent/Permanent Item #	Price	Leveling Plate Item #	Price
Expandable 18' 6" - 23' 4"	Max-1	6'	20'	FBGP-520AX	\$8,695 pair	FBGP-420AX	\$9,995 pair
	Max-1	8'	20'	FBGP-820AX	\$8,895 pair	FBGP-920AX	\$10,295 pair



FieldPro Football Ball Stop System

Backstops are installed behind football goal posts to keep field goals and extra point kicks inside the field. 40'W net can easily and quickly be raised and lowered during games or practice with a rope and marine style swivel pulley system with integrated ball bearings. Includes heavy duty 6-5/8" diameter aluminum poles, ground sleeves, corrosion resistant hardware and 3-1/2" square mesh #36 knotless nylon black net with 1/4" rope border. Available in 30' or 40' heights. Poles can be powder coated black, call Customer Service for details. More Field Netting is available on pages 97-99.

FNFB-30 30'H x 40'W 530 lbs. **\$4,195 each**

FNFB-40 40'H x 40'W 762 lbs. **\$6,595 each**

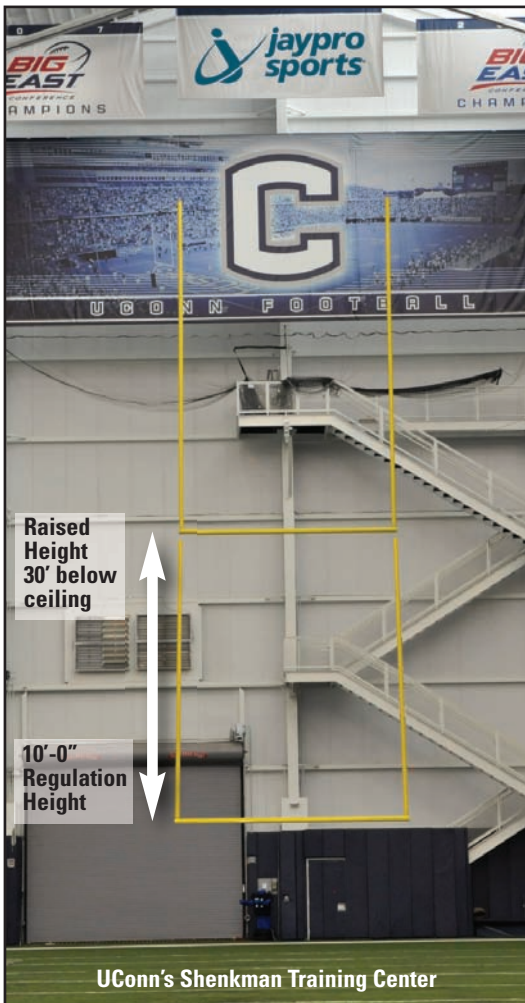
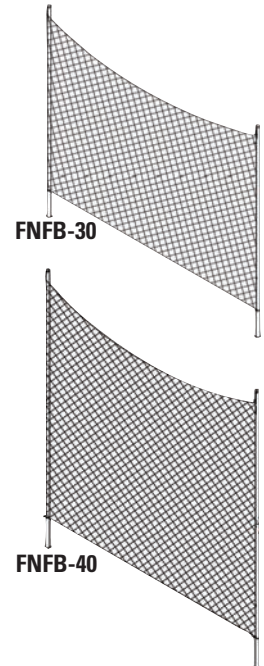

Indoor - Ceiling Suspended and Retractable Football Goal Posts

Ceiling hung football goal posts for indoor practice facilities. Allows kickers to practice indoors, or for use during indoor scrimmages. Material sizes are the same as found on high end outdoor goal posts. Crossbar is 6-5/8" O.D. Aluminum tubing by 18'-6" wide. Uprights are made from 4" O.D. Aluminum tubing, and measure 30 feet tall. Comes with a leveling feature to ensure the crossbar is level. Powder coated yellow.

Ceiling Suspended Goal Post

Suspended directly beneath the building structure, attaches directly to rigid frame girders, building trusses, I-beams or roof purlins. Comes complete with all attachment and suspension hardware.

CSGP-1 390 lbs. **\$2,895 each**

Retractable Ceiling Suspended Goal Post

Similar to the CSGP-1 but includes a 1 HP hoisting system to raise the goal post out of the way when not in use. Comes complete with 1 HP electric winch, pulley and cable system, and all attachment and hoisting hardware. Winch mounts directly to end wall structure.

CSGP-2 510 lbs. **\$4,649 each**

**23'-4" width goal post
(High School dimensions)
also available.**

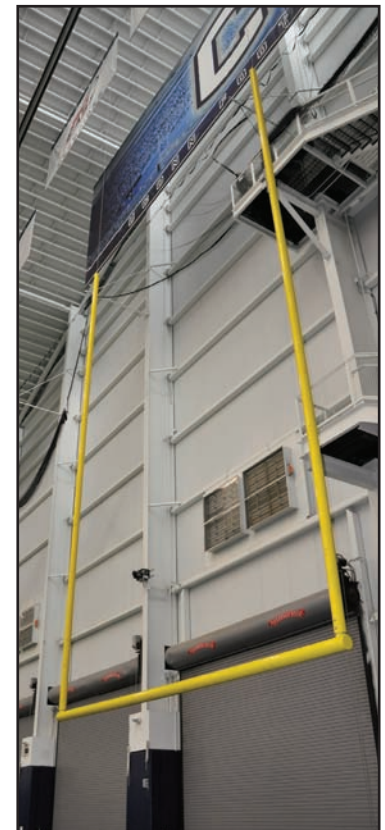

Retractable ceiling suspended football goal posts for indoor practice facilities. Raise the goal post out of the way when not in use!

Max-1 Accessories

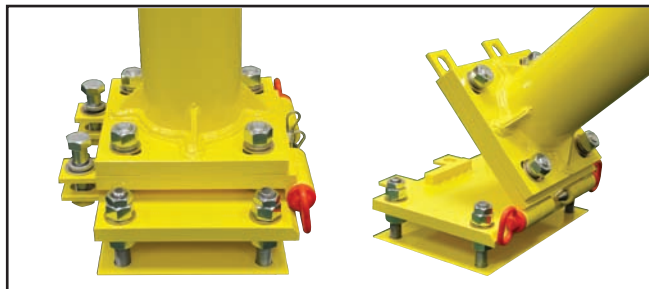

Football Hinge Kit

Ideal for multi-purpose facilities, the hinge kit allows any surface mounted Max-1 goal to be lowered and dismantled from ground level by a maintenance crew. Opposing pull pins offer easy separation of the hinge plates. The welded shackle bracket on the Max-1 gooseneck offers an attachment point for a cable or hoist. Requires the FBGPAF-2 access frame kit (available separately, see to right).

FBHG-1

\$695 each

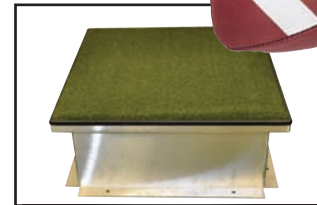
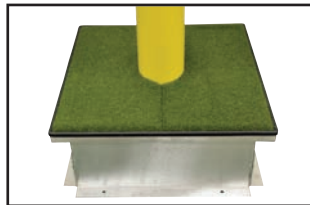

Access Frame and Covers

For use with semi-permanent goal posts requiring removal. Can be used on grass or turf fields. Turf cover hides anchoring hardware while allowing access when required. Constructed of aluminum, pressure treated plywood and artificial turf. Includes two frames and four turf covered plates; two split panels for use with goal post and two full panels for when goal post is removed. Available in two sizes (larger size used with goal post hinge kit).

FBGPAF-1 18-1/4" L x 18-1/4" W x 8" H

\$1,295 pair

FBGPAF-2 29" L x 29" W x 11-5/8" H

(for use with goal post hinge kit)

\$1,495 pair



Soccer/Football Anchor Kits

Fastens the rear crossbar of the soccer goal to the football goal gooseneck.

SFGA-6 6-5/8" O.D. Gooseneck

\$139 each

SFGA-5 5-9/16" O.D. Gooseneck

\$129 each

SFGA-4 4-1/2" O.D. Gooseneck

\$119 each



Wind Streamers

4" W x 42" L w/ grommets.

WS-42

1 lb.

\$20 pair

Ground Sleeve w/ Height Adjuster

Make life easier with this adjustable ground sleeve. Get the perfect alignment with a simple tweek rather than starting from scratch.

6-5/8" diameter

FBGPGS-8

\$1,149 pair

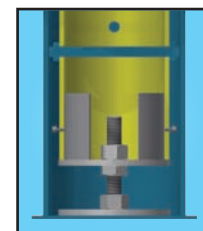

Standard Ground Sleeve

6-5/8" diameter

FBSLV8

\$895 pair

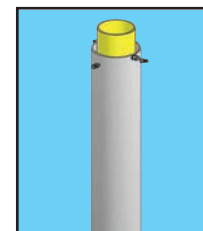

Goal Post Padding



Pro-Style Round Post Protector Pads

Professional style pads for 4-1/2", 5-9/16" or 6-5/8" O.D. goal posts. 6' H pads are made of 6" thick foam covered by 14 oz vinyl. Hook and loop attachment. See below for color selections.

PPP-500 4-1/2" O.D. Post 35 lbs.

\$749 pair

PPP-700 5-9/16" O.D. Post 40 lbs.

\$795 pair

PPP-800 6-5/8" O.D. Post 45 lbs.

\$949 pair



Shown with custom lettering



NEW COLOR!

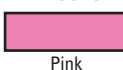

Pink



Economy Post Protector Pads

Designed for 4-1/2" O.D. goal posts. 6' H pad is made of 4" thick foam covered by 14 oz vinyl. Grommet attachment, cord included. See below for color selections.

4-1/2" O.D. Post

PPP-5

18 lbs.

\$425 pair



Custom Lettering

(As shown to the left) Put your school name on your pads! White vinyl letters as shown. 3-9 letters on one pad.

PVL-39

white lettering

\$159



Please Note: Colors may not be an exact match.



NEW VOLLEYBALL SOCCER FOOTBALL LACROSSE BASEBALL FIELD MARKING SCOREBOARD BASKETBALL GYMNASIUM FIELD SEATING BALL STORAGE PHYS. ED. TENNIS



Heavy-duty swivel casters

48 HOUR QUICK SHIP



SP-2

Shoulder Pad StackMaster™

Roll-a-way 1-5/16" O.D. steel storage/transportation rack holds up to 42 shoulder pads. Powder coated for extra durability! Heavy-duty swivel casters assure complete portability even when fully loaded. 2'W x 6'6"H.

SP-2

37 lbs.

\$195 each



48 HOUR QUICK SHIP

Shoulder Pad StackMaster™ Cart

SP4

Transport and store 60-80 shoulder pads on this deluxe 4-wheel cart. This all-steel unit moves easily on four heavy-duty non-marking casters and has a removable transport handle. Size 24"W x 60"L x 70"H.

SP4

69 lbs.

\$269 each



H-1



48 HOUR QUICK SHIP

Helmet StackMaster™

This heavy duty portable helmet storage/transportation rack holds up to 56 helmets. Rugged all-welded steel base has 4 swivel casters for easy portability. 2'6"W x 6'3"H.

H-1

59 lbs.

\$239 each



Helmet StackMaster™ Cart

Transport and store 60 football helmets with masks on this 4-wheel cart. Constructed of 1" O.D. chrome steel tubing and includes 4" casters for easy mobility. Will fit through a standard doorway. Can also be used for lacrosse and baseball batting helmets. Size 24"W x 61"L x 64"H.

NEW

Heavy-duty swivel casters

FHC-1

61 lbs.

\$259 each

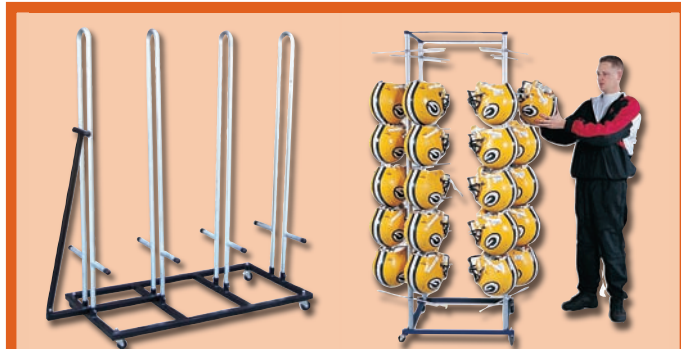

Save \$\$\$ with a Package Deal on Storage Equipment for the Football Program...

FRP-2 Football Rack Package, Includes a SP4 & a H-1

A SAVINGS OF \$89

Priced Separately at \$508

\$419 package

Snap Attack Football Machine

The Snap Attack is a snap, pass and kick machine that will maximize your time on the most difficult to practice phases of the game. Features include universal ball feed cradle, elevation control and lever clamp combined with a locating pin to make changes from spirals to kick-offs easy and quick. Speeds of 70+ mph and distances of 100 yards for passes and punts, 70+ yards for kick-offs and 5-15 yards for snap-tight spirals. Ball release points at 5' for passes and ground level for snaps.



SAFM-1 90 lbs.

\$4,199 each

Wet and Dry Field Marking products and Line Layout Systems are located on pages 67-69





- ① Fully padded chain suspended lower frame
- ② 12" heavy duty swivel casters
- ③ Reinforced heavy walled steel frame
- ④ Easily adjust the frame height from 42" to 66" with handle pull pin



The Lowdown Linemen Chute

Train your linemen and backers to stay low. Run your blocking scheme and trap drills. Wide open access from all sides. Black weather resistant mesh fabric screen is light weight, durable and won't scratch player's helmets. Telescoping legs allow frame height to be easily adjusted. Frame can be angled to any position by adjusting the support chains. Comes standard with four 12" heavy duty pneumatic swivel casters to allow easy transport and storage. Upper frame is made of heavy walled steel and reinforced for added stability, while lower frame is made of light weight aluminum. Comes in two sizes, 30' x 6' and 20' x 6'. Available in neon yellow.

FBLC-20	20' x 6'	450 lbs.	\$3,195 each
FBLC-30	30' x 6'	500 lbs.	\$4,395 each



Crushable Sideline Markers

Self-standing with weighted bottom. 12"H numerals on both sides, stores flat. Heavy duty cover. 11 piece set. Does not ship from Jaypro's CT warehouse. Call for freight quote.

FBWSM	39 lbs.	\$325 set
--------------	---------	------------------

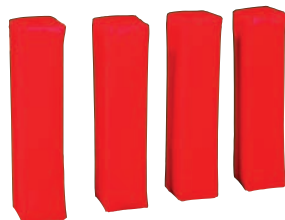

FBPYLN

Free Standing and Anchorless Pylons

Self standing end zone pylon. Weighted bottom. 4 piece set. Official size: 4"L x 4"W x 18"H. Does not ship from Jaypro's CT warehouse. Call for freight quote.

FBPYLN	12 lbs.	\$49 set
---------------	---------	-----------------



FBPRCV

Curved Pro Body Shield

Precurved 4" thick foam. Vinyl cover with handles. Royal Blue. Size: 24" x 16" x 4". Does not ship from Jaypro's CT warehouse. Call for freight quote.

FBPRCV	4 lbs.	\$72 each
---------------	--------	------------------



Chain Sets

Completely padded. Bright orange targets. Plated chain and swivel hooks eliminate kinks and knots. Comes in 2 sizes. Does not ship from Jaypro's CT warehouse. Call for freight quote.

FCS-8	8'	15 lbs.	\$339 each
FCS-7	7'	8 lbs.	\$225 each



FFD-10

Flip Down Indicator

Completely padded. Super durable numbers. Does not ship from Jaypro's CT warehouse. Call for freight quote.

FFD-10	8 lbs.	\$225 each
---------------	--------	-------------------



TKSLDV

SackBack Tackle Sled

Please call or visit us online to get all the info on our sleds and training equipment! Does not ship from Jaypro's CT warehouse. Call for freight quote.

TKSLDV	Varsity	225 lbs.	\$969 each
TKSLDP	Pro	295 lbs.	\$1,169 each

Linemen Chute - Single or Multiple

Great instruction tool to teach the basics of coming off the ball low and drive upward. Adjustable entrance with three height positions. Heavy-duty 1-5/8" steel tube frame with long lasting powder coated finish. **Chutes can be attached to each other to replicate entire line.** Overall size: 4'L x 5'H.



FBLMCH

55 lbs.

\$179 each



Offering a Football Training Package to help save your Program \$\$\$...

FBTP-3 Football Training Package, Includes a FBLMCH, a FBHSTP & a PK-64
A SAVINGS OF \$68 Priced Separately at \$587 **\$519 package**



Professional Portable Kicking Cage

Portable kicking cage for quick warm up. Heavy duty 1-5/16" galvanized steel frame with a deep net to help contain balls. Folds down easily for storage. Includes a black Cordura carry bag for transport (78" x 11" diameter). Heavy-duty knottless nylon kicking net. Size: 48"W x 48"D x 86"H.

PKC-1 37 lbs. **\$489 each**

Replacement Net
PKC-1N 5 lbs. **\$129 each**



Carry Bag Included!



Portable Kicking Cage

Assembles in minutes **without** tools. Rugged 1-5/8" powder coated frame is designed for maximum stability. 6'6"H x 4' W. Includes heavy-duty, slip-on nylon net. Weighted base (26 lbs.).

PK-64 35 lbs. **\$169 each**



High Stepper Agility Trainer

Designed for building foot speed and agility. Powder coated steel tube frame with suspended rope running grid with 16 squares. Adjust to five different heights to increase leg lift. Designed for quick assembly and safety with tubing frame outside the running grid. 20' L with 6"W.

FBHSTP 45 lbs. **\$239 each**

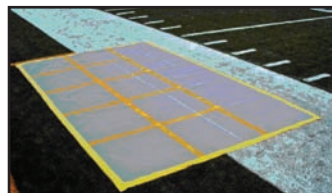

Call for info on all our Turf Protector Products

Cross-Over Zone® Track Protector, Huddle Zone® Special Team Mat, Bench Zone® Sideline Track Protector, Bench Zone® Sideline Turf Protector



Official Field Hockey Goals with Bottom Boards

This attractive goal meets official specifications. Steel construction is extremely durable. Goal size is 7'H x 12'W x 4'D. Heavy Duty 2" x 2" square steel goal face. Rear frame constructed of 1-5/16" O.D. galvanized steel powder coated white. All welded side frames and top rear cross bar for maximum stability. **Jaypro Exclusive! Official black bottom boards of 1/2" thick High Density Polyethylene that will never fade or break!** Unique "money clip" style net clips simplify net attachment. Meets NCAA, NFHS and FIH specifications. Nets available separately, see below. Optional heavy-duty 10" no-flat wheel kit available for easy transport, see below.

OFHG7124

534 lbs.

\$2,495 pair



Official Field Hockey Bottom Board

Includes black high density polyethylene boards and all necessary hardware for attachment to most goals.

FHG-16

164 lbs.

\$1,039 pair

Transports Easy With Large 10" No-Flat Wheels!

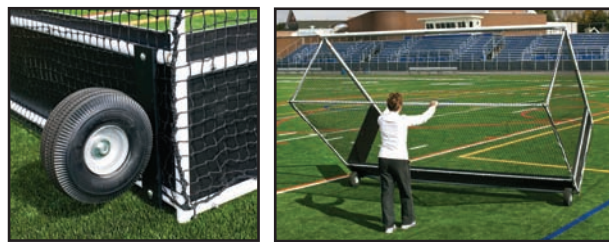

Optional Wheel Kit

Optional "tip and roll" wheel kit makes our goals easy to transport! Four heavy duty 10" no-flat wheels. One set fits one pair of goals.



FHGWK

49 lbs.

\$329 set

Official Field Hockey Net

7'H X 12'W X 4'D weatherproof 1-3/4" sq. mesh, 2.5 mm polyethylene material.

FHND-8

19 lbs.

\$199 pair

NEW

Offering a Field Hockey Package to help save your Program \$\$\$...

OFHG7124PKG

Field Hockey Package, Includes a OFHG7124, a FHND-8 and a FHGWK

A SAVINGS OF \$324

Priced Separately at \$3,023

\$2,699 package



Official Field Hockey Goals without Bottom Boards

Same as the above goal, minus the bottom boards.

OFHGNBB

370 lbs.

\$1,449 pair



Optional Wheel Kit

Optional "tip and roll" wheel kit makes our goals easy to transport! Four heavy duty 10" no-flat wheels. One set fits one pair of goals.

FHGWK

49 lbs.

\$329 set

Practice Field Hockey Goal

Official size 7'H x 12'W x 4'D with 1-5/16" O.D. galvanized steel frame and cast aluminum corner fittings for easy assembly. **Includes net (black).**

PFHG-41

63 lbs.

\$495 each

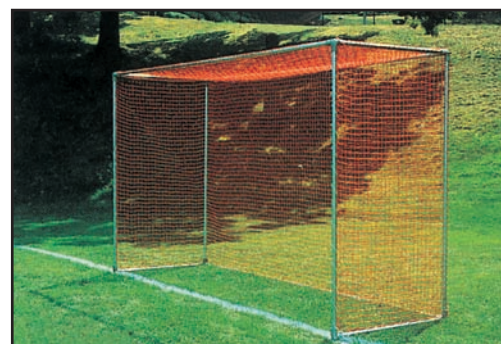

NEW VOLLEYBALL SOCCER FOOTBALL LACROSSE BASEBALL FIELD MARKING SCOREBOARD BASKETBALL GYMNASIUM FIELD SEATING BALL STORAGE PHYS. ED. TENNIS

6' x 6' GOAL**Deluxe Official Lacrosse Goals**

This ultimate Lacrosse goal has mitered and welded corners for exceptional performance. Full size 6'H x 6'W x 7'D meets all NCAA and NFHS requirements for men's lacrosse. 1/4" steel net tie rail for a clean goal face and bottom. 2" O.D. steel pipe construction for full NCAA compliance. Powder coated orange over rust-proof zinc coated steel pipe. **Nets available separately**, see below.

LG-50

170 lbs.

\$649 pair

Net rail keeps the goal face and bottom frame free from tape and string for an attractive, professional appearance



Rear brace lays flat along the ground to eliminate any obstruction to the ball.

LG-50

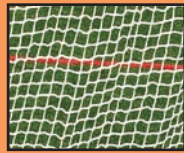
Five Year Warranty!

Offering a Lacrosse Goal Package to help save your Program \$\$\$...

LG-50PKG

Lacrosse Goal Package, Includes (1 pair) LG-50 Goals and (2) LGN-50 Nets

A SAVINGS OF \$32

Priced Separately at \$927

\$895 package

LG-540

**Includes Net!**

Net has a pocket that lies under the goal to help put on the net and keep it in place!

**Deluxe Practice Lacrosse Goals**

A great value goal! Full size 6' x 6' x 7'. 1.75" O.D. steel powder coated for extra durability. Deluxe 2.5mm net included.

LG-540

Goal

37 lbs.

\$199 each

LACROSSE NETS

Competition Lacrosse Net

5mm knotless netting, 1-1/2" squares. Official size 6' x 6' x 7'. Meets all NFHS and NCAA regulations. Weatherproof white polyester with natural UV stabilizer. Triple stitched webbing binder. Includes lacing cord.

LGN-50

15 lbs.

\$139 each**Practice Lacrosse Net**

3mm knotless netting, 1-1/2" squares. Official size 6' x 6' x 7'. Meets all NFHS and NCAA regulations. Weatherproof white polyester with natural UV stabilizer. Triple stitched webbing binder. Includes lacing cord.

LGN-30

13 lbs.

\$98 each**Practice Lacrosse Net**

2.5mm knotless white netting, 1-1/2" squares. Official size 6' x 6' x 7'. Includes lacing cord.

LGN-25

11 lbs.

\$74 each

Box Lacrosse

Official indoor lacrosse goal. Designed for 6 vs 6 play. 4'H x 4'W x 4'D. Constructed of 2" O.D. steel with mitered and welded corners for exceptional performance. 1/4" steel net tie rail for clean goal face and bottom. Powder coated orange over rust-proof zinc coated steel. Includes 3 mm, 1-1/2" sq. mesh knotless polyester net with lacing cord.

LG-44B	Goal with net	49 lbs.	\$249 each
LGN-44	Replacement net	6 lbs.	\$75 each



This smaller Box Lacrosse Goal has the features along the net rail and rear brace that is evident on our Deluxe Lacrosse Goals!

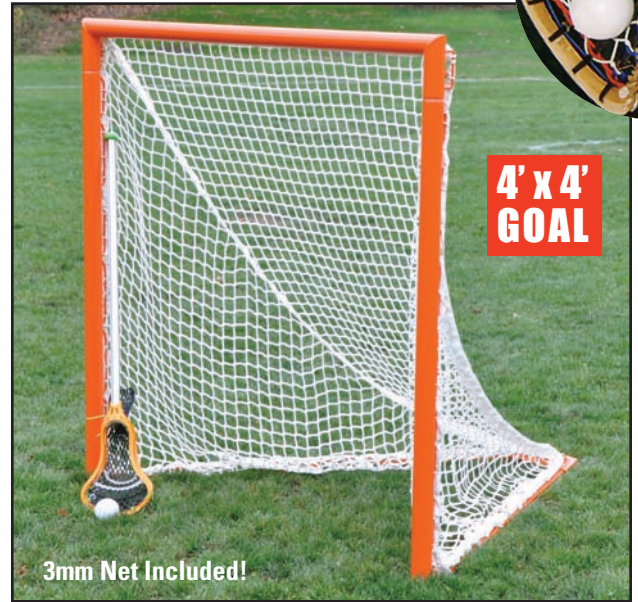

4' x 4' GOAL

3mm Net Included!



Lacrosse Folding Goal

Great for back yard practice or take it with you to the field! 6' x 6' lacrosse goal is constructed of heavy duty 1" aluminum tubing that is powder coated white. Net comes already attached to the frame, making it easy to unfold and set up in seconds! Collapses down to 4'H x 8" x 8" and fits into a convenient carry bag. Goal anchors included.



Carry Bag Included!

LG-66FL	39 lbs.	\$169 each
----------------	---------	-------------------

Lacrosse/Multi-Sport Ball Stop System

15' x 65' FieldPro System

Stop wasting time during practices and games chasing missed shots or errant passes and ensure the safety of athletes, coaches and spectators on adjacent fields. 15'H x 65'L backstop is designed ideally to fit behind lacrosse goals. Includes four 4" O.D. heavy wall aluminum uprights with black powder coated finish, ground sleeves, corrosion resistant hardware and 1-3/4" square mesh #36 knotless nylon black net with 1/4" rope border. Net can easily be raised and lowered with a rope and pulley system.



FNMB-65	15'H x 65'W	\$2,295 each
----------------	-------------	---------------------

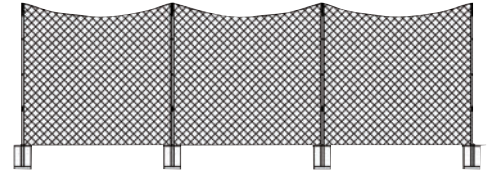

Lacrosse Rebound Net

Work on your shots and passes with this adjustable rebounder! Durable steel tube frame is 4'W x 8'H. Rebounding target net area is 4'H x 3'W. Adjust the angle with a simple turn of a hand knob.

LAX-RBD	35 lbs.	\$239 each
----------------	---------	-------------------



Lacrosse Target Net

Apply to the front of your goal for a challenging practice. Carry bag included.

LAX-TN	2 lbs.	\$69 each
---------------	--------	------------------



Field ID Markers

14" x 14" vinyl markers with corner grommets to put on the back of the net of each goal. Specify color and numbers when ordering.

FIM-14	1 lb.	\$19 each
---------------	-------	------------------

Wet and Dry Field Marking products and Line Layout Systems are located on pages 67-69

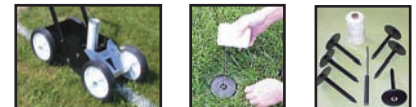

The **BIG LEAGUE!**

Shown with optional ricochet padding upgrade kit.

Compare us to
the Competition!



Dodd Stadium
Home of the
Tigers
CONNECTICUT

The "BIG LEAGUE" Professional Portable Batting Cage

Standard Features Include: Size open: 18'W x 22'D x 12'H, folded down: 18'W x 12'D x 5'H. Constructed of heavy-duty 2" Sch 40 Aluminum tube. Black heavy duty #42 climatized nylon net with rear net baffle. 4' x 6' x 4" thick thud pad, vinyl skirt & standard black ricochet padding on all overhead framing. Dual coaches' stands with leaning bar that also serves as a convenient strut holder. **Jaypro Exclusives! Patent Pending. Locking quick release safety strut clamps (see page 50); swivel side wheels that lock into position; rear wheel handle can be lifted or lowered to move cage.**

BGLC-7500RB Royal Blue



BGLC-7500RD Red



BGLC-7500NB Navy Blue



BGLC-7500BK Black



BGLC-7500GR Green



600 lbs.

\$4,995 each



Dual Coaches
Stand & Strut
Holder

Rear Wheel
Handle



BLN-3 Replacement Net

75 lbs.

\$759 each

Replacement Skirt

Royal Blue (RB), Black (BK), Red (RD), Green (GR), Navy Blue (NB)

SKT-75XX 30 lbs.

\$359 each

Replacement Thud Pad

Royal Blue (RB), Black (BK), Red (RD), Green (GR), Navy Blue (NB). Does not ship from Jaypro's CT warehouse. Call for freight quote.

THUD-46XX 20 lbs.

\$399 each

Ricochet Padding Upgrade Kit

Upgrade your cage with durable vinyl covers. Wraps around foam ricochet padding. Hook and loop attachment. Kit is 21 six foot lengths. Royal Blue (RB), Black (BK), Red (RD), Green (GR), Navy Blue (NB)

RPAD-UKITXX 10 lbs.

\$649 kit



18" diameter x 8"W pneumatic side wheels lock into position and swivel to change direction!



Coaches Storage Bin with perforated aluminum and hinged cover.

Coaches Storage Bin

BL-CSBIN \$149 each



Optional Tow Hitch Conversion Kit allows your cage to be towed with any utility vehicle!

Tow Hitch Conversion Kit

BL-TOWKIT \$195 each

Please visit our website or call Customer Service for more information.



The GRAND SLAM!

Best Seller!

Compare us to the Big Bubba!



48 HOUR QUICK SHIP



Shown with optional skirt graphics and additional ricochet padding.

The "GRAND SLAM" Semi-Professional Portable Batting Cage

#1 style for Spring Training Camps! Designed for semi-professional and collegiate use. **Standard Features Include:** Size is 18'W x 22'D x 12'H. Constructed of 2" heavy wall aluminum tubing. Easy to fold and collapses to just 5' high. Frame features handy strut holders too! Coaches rear safety railing for safe viewing. Enhance your unit with the optional coaches stand. Transports easily on three 16" pneumatic turf wheels. Black heavy duty #42 climatized nylon net. Includes heavy vinyl coated nylon skirt that protects the metal frame and gives the pitcher an attractive visual backstop. Rear net baffle reduces wear and tear on net and skirt. 60' of ricochet cushion reduces rebound and frame damage. **Jaypro Exclusive! Patent Pending. Locking quick release safety strut clamps (see page 50).**

505 lbs.

\$4,195 each



BBGS-18
Green



BBGS-18RB
Royal Blue



BBGS-18RD
Red



BBGS-18NB
Navy Blue



This unit collapses easily, provides handy strut storage, and folds to a compact size that's easy to transport.

Optional Graphics

SKT-LOGO Name & Logo printed on skirt
Call for price quote

Replacement Skirt

Green (GR), Red (RD), Royal (RB), Navy (NB)

SKT-75XX

30 lbs.

\$359 each

Replacement Nets

BLN-3

18'x22'x12'

75 lbs.

\$759 each

Old Style: Prior to 2013

GSN-1

17'6" x 18' x 12'

65 lbs.

\$749 each

Optional Viewing Stand

Now coaches can view batting practice from this convenient adjustable stand.

CVS-10

24 lbs.

\$329 each

Additional Ricochet Cushion

BPD-6

6' lengths

2 lbs.

\$26 each

Additional Weather Resistant Tape

PDT-3

60 yd rolls

2 lbs.

\$62 each

NEW VOLLEYBALL SOCCER FOOTBALL LACROSSE BASEBALL FIELD MARKING SCOREBOARD BASKETBALL GYMNASIUM FIELD SEATING BALL STORAGE PHYS. ED. TENNIS

The **LITTLE SLAM!****The "LITTLE SLAM" Portable Batting Cage**

Designed for collegiate or high school use, this portable batting cage offers many of the features of the Grand Slam but at a more competitive price. **Standard Features Include:** Size is 17' 6"W x 12'D x 12"H. Constructed of 2" heavy wall aluminum tubing. Transports easily on three 16" pneumatic turf wheels. Black heavy duty #42 climatized nylon net with rear baffle. Optional vinyl skirt protects the metal frame while giving the pitcher an attractive visual backdrop. 24' of ricochet cushion reduces rebound and frame damage. **Jaypro Exclusive! Patent Pending. Locking quick release safety strut clamps (see below).**

BBL-12

410 lbs.

\$3,395 each

Get the look and feel of a Pro Cage, on a budget!



Provides handy strut storage.



Easy to fold and collapse for transport or storage. Shown with optional vinyl skirt.

Jaypro Exclusive - Optional Vinyl Skirt Colors**SKT-20 (Green) SKT-20RB (Royal Blue)****SKT-20RD (Red) SKT-20NB (Navy Blue)**

23 lbs.

\$329 each

Replacement Net

LSN-2

55 lbs.

\$749 each

Powder Coated Green

The **LINE DRIVE!****The "LINE DRIVE" High School Foldable and Portable Batting Cage**

Standard Features Include: Size is 16'6"W x 16'6"D x 12"H. Fold's down to 48"H. Constructed of 2" flo-coated galvanized steel with green powder coat finish. 16" pneumatic wheels. Oversize rear wheel cranks and swivels for easy mobility. Includes heavy duty, #42 knotless nylon weather treated netting with rear baffle. Includes 18' of ricochet padding. **Jaypro Exclusive! Patent Pending. Locking quick release safety strut clamps (see below).**



Conveniently folds to 4' H. This unit collapses smoothly for easy transport and provides handy strut storage.

Shown with optional vinyl skirt and additional ricochet cushion.

**BBLD-5000**

650 lbs.

\$3,395 each

Replacement Net

LDN-5

34 lbs.

\$749 each

Optional Vinyl Skirt

SKT-50

23 lbs.

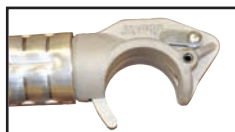
\$329 each**Jaypro Exclusive! Patent Pending**

Locking quick release safety strut clamps prevent inadvertent and dangerous release. These struts are standard with all Jaypro Batting Cages!

Call Jaypro for details on all options for our batting cages, or visit www.jaypro.com for information!





Perpendicular Style with Polyester Coating

The Arch™ BACKSTOP

Only from Jaypro: A Backstop in COLORS!!!
Available in Black, Brown and Green!
 Call Customer Service for Details and Pricing



Permanent Baseball / Softball Backstops

Upright sections: 10'W x 12'H. Main upright 2-3/8" O.D. x .095"W galvanized steel. Fasteners: all galvanized fittings, nuts, bolts. Fence Fabric: 9 gauge smooth galvanized. Crossbars: 1-5/8" O.D. x .085"W galvanized steel. Backstop sections are not prefabricated chain link. Overhang sections: 10'W x 6'D.

AVAILABLE COMBINATIONS

Item	Description	Weight	Price
BSP-30	3 Panel only	552 lb/ea	\$1,899
BSP-30-6	3 Panels, 1 Center Overhang	682 lb/ea	\$2,199
BSP-33-2	3 Panels, 1 Center, 2 Wing Overhangs	860 lb/ea	\$2,999
BSP-40	4 Panels only	727 lb/ea	\$2,499
BSP-40-66	4 Panels, 2 Center Overhangs	956 lb/ea	\$3,295
BSP-44-22	4 Panels, 2 Center, 2 Wing Overhangs	1134 lb/ea	\$3,995



ALL BACKSTOPS SHIP TRUCK, CALL FOR A FREIGHT QUOTE!



Backstop Padding

Backstop Padding

Backstop padding is 2" thick high impact foam and has grommet flaps on all 4 sides for attachment to chain link fencing. 2' folding sections (available in solid or alternating colors). Available in several sizes and colors. Eco-friendly padding and optional graphics available, call for details and pricing. Does not ship from Jaypro's CT warehouse. Call for freight quote.



Backstop Padding shown with Optional Graphics



Item	Size	Price
BSP236	3' x 6'	\$279
BSP238	3' x 8'	\$289
BSP2310	3' x 10'	\$345
BSP2312	3' x 12'	\$389

Item	Size	Price
BSP246	4' x 6'	\$289
BSP248	4' x 8'	\$345
BSP2410	4' x 10'	\$399
BSP2412	4' x 12'	\$459

Backstop & Field Wall Colors

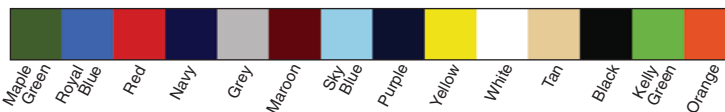

Field Wall Padding

Field Wall padding is 2" thick high impact foam on 3/4" outdoor water sealed wood ply boarding. Available in several sizes and colors. Eco-friendly padding and optional graphics available, call for details and pricing. Does not ship from Jaypro's CT warehouse. Call for freight quote.

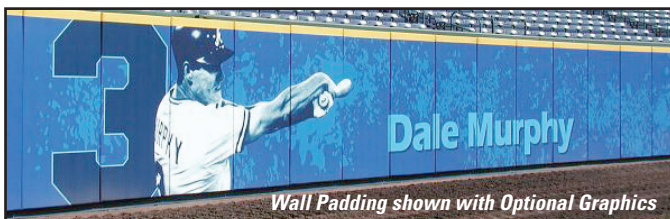

Wall Padding shown with Optional Graphics



Item	Size	Price
FWP246	4' x 6'	\$359
FWP248	4' x 8'	\$465

Item	Size	Price
FWP2410	4' x 10'	\$615
FWP2412	4' x 12'	\$709



Wall Padding

NEW VOLLEYBALL SOCCER FOOTBALL LACROSSE BASEBALL FIELD MARKING SCOREBOARD BASKETBALL GYMNASIUM FIELD SEATING BALL STORAGE PHYS. ED. TENNIS

48 HOURS
QUICK SHIP

- Larger in size to accommodate the Pro Player
- No-Flat Tires for easy Transporting
- Heavy Wall Aluminum Construction
- Double-Sided Slip-On Net

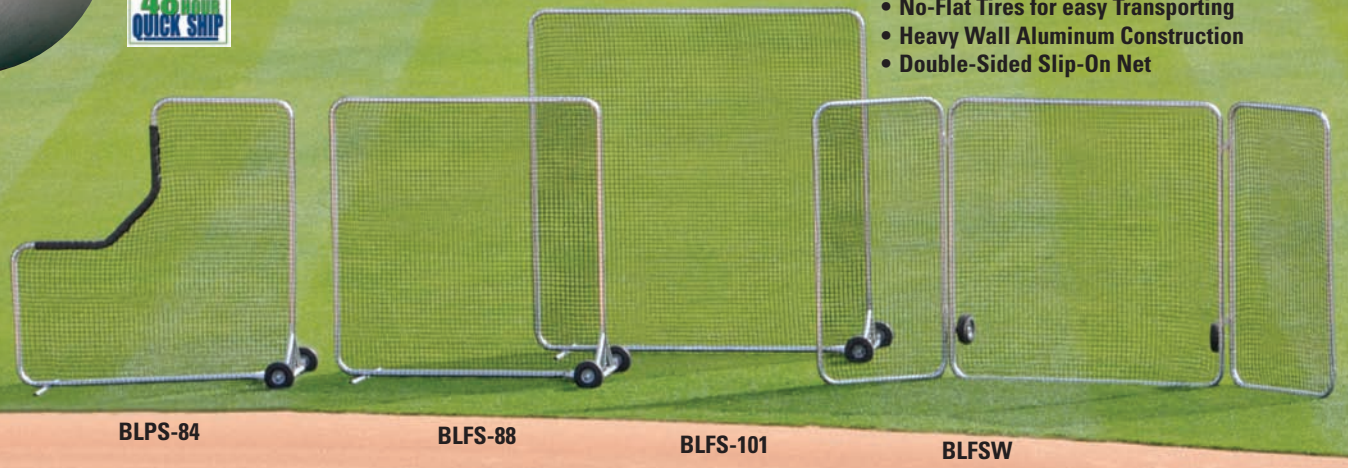

BLPS-84

BLFS-88

BLFS-101

BLFSW

Constructed of heavy wall schedule 40 aluminum 2" O.D. pipe. Heavy duty legs are welded to provide extra rigidity. Comes with black, rugged, weatherproof #42 knotless nylon double-sided slip-on net. Includes **two 10" diameter x 4"W NO-FLAT TIRES** that make transporting the unit easy.



**Big League Pitcher's
Safety Protector**

Larger L-shaped design with padded hip protector provides safety for pitchers. Size is 8'H x 8'W. Refer to page 31 for sandbags for extra support.

L-Screen

BLPS-84

45 lbs.

\$749 each

L-Screen Replacement Net

BLPS-84N

3 lbs.

\$189 each

**Heavy duty 2"
legs and supports
are welded for
extra strength**



**Includes two
10" x 4"
NO-FLAT TIRES!**



**Big League Fungo
Screens**

Larger size to protect your fielders from stray balls. Size's are 8'H x 8'W and 10'H x 10'W. Refer to page 31 for sandbags for extra support.

8 x 8 Screen

BLFS-88

45 lbs.

\$759 each

10 x 10 Screen

BLFS-101

55 lbs.

\$849 each

8 x 8 Replacement Net

BLFS-88N

3 lbs.

\$189 each

10 x 10 Replacement Net

BLFS-101N

4 lbs.

\$229 each



**Big League Fungo
Screen with Wings**

Tri-fold screen. Main screen is 8'H x 8'W with two 8'H x 4'W wings. This provides an overall screen size of 8'H x 16'W. Wings fold in, and 2 no-flat tires help with easy transport. Refer to page 31 for sandbags for extra support.

Screen

BLFSW

90 lbs.

\$999 each

Wing Replacement Net

BLFSW-N

3 lbs.

\$99 each

Center Replacement Net

BLFS-88N

3 lbs.

\$189 each

Great for 2nd base or Infield protection!

**Fold the wings in
and you are ready
to move!**

**Transporting this unit
is quick and easy!**

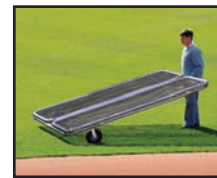

Dodd Stadium
Home of the **CONNECTICUT
Tigers**

Optional Safeoam Padding

Optional padding for the pitcher's safety protector frame and fielder's screens. Royal blue, red and green padding is sold in 8' lengths and attaches with ties. Ties are sold separately and include 100 ties per bag. Does not ship from Jaypro's CT warehouse. Call for freight quote.

Royal Blue

Red

Green

SF-PREMRB

SF-PREMRD

SF-PREMGR

Safeoam Padding

\$59 each

SF-TIESRB

SF-TIESRD

SF-TIESGR

19" Ties

\$42 bag



**For additional
safety, use
sandbags to
counterweight
your screens!**



Refer to page 31 for details.





Net and Wheel Kit Included!

Constructed of heavy gauge 1-5/8" O.D. galvanized steel tubing with a durable, attractive green powder coated finish. Heavy duty 2" square galvanized steel legs provide extra rigidity. **Long lasting, high quality black, rugged, weatherproof #42 knotless nylon double-sided slip-on net.** Includes two 8" diameter wheels that make transporting unit easy.

Collegiate Fielder's Screens

Required protection screens for players during batting and fielding practice. 7'H x 7'W and 10'H x 10'W.

- FS-77** 7 x 7 complete screen 67 lbs. **\$299 each**
- FS-101** 10 x 10 complete screen 77 lbs. **\$349 each**
- FS-77N** 7 x 7 replacement net 3 lbs. **\$119 each**
- FS-101N** 10 x 10 replacement net 4 lbs. **\$149 each**
- FSE-76N** 7 x 6 Green Economy net 3 lbs. **\$72 each**



2" square galvanized steel legs help support and steady even the biggest screen!

Collegiate Pitcher's Safety Protector

Versatile 7' x 7' "L-Shape" design accommodates left or right-hand pitchers. Works with pitching machine or live arm delivery.

- PS-84** 7 x 7 L-complete screen 67 lbs. **\$299 each**
- PS-84N** 7 x 7 L-replacement net 3 lbs. **\$109 each**
- PSE-76N** 7 x 6 Green Economy net 3 lbs. **\$82 each**

BEST VALUE SERIES

A Jaypro Collegiate Style Screen is an Excellent Choice for College or High School Use as well as our Best Value. Durable Powder Coated Finish, Heavy Duty Stable Legs, Slip-On Nylon Nets and Wheel Kits make these Units Hard to Beat!



SBPE-77

Softball Protector Screen

Ideal for softball pitchers. 7'H x 7'W frame with a cutout. **Net and wheel kit included.**

- SBPE-77** 7 x 7 complete screen 67 lbs. **\$299 each**
- SBPE-77N** 7 x 7 replacement net 3 lbs. **\$109 each**



Refer to page 31 for sandbags for extra support.



Net and Wheel Kit Included!



PSTS-77

Portable Soft Toss/Batting Practice Screen

Heavy duty frame for use with both baseball and softball. Balls are collected in the sock for re-use. 7'H x 7'W. **Net and wheel kit included.**

- PSTS-77** 7 x 7 complete screen 67 lbs. **\$349 each**
- PSTS-77N** 7 x 7 replacement net 3 lbs. **\$149 each**
- PSTS-76N** 7 x 6 Green Economy net 3 lbs. **\$82 each**

NEW VOLLEYBALL SOCCER FOOTBALL LACROSSE BASEBALL FIELD MARKING SCOREBOARD BASKETBALL GYMNASIUM FIELD SEATING BALL STORAGE PHYS. ED. TENNIS



Easy to Install...
Easy to set up and take down the net!



Batting Tunnel Turf available on page 55

TUNNEL FRAMES

Professional Outdoor Batting Tunnel Frame

Individual hoist lines makes for easy installation and removal of net. Clean design with less structure for ball to ricochet off. Supports are curved to provide 2 feet of offset, and made of 4" O.D. aluminum tubing, offering ease of removal and storage. Includes ground sleeves. Accommodates both 12' and 14' wide nets. (Nets sold separately).

PROTF-70	12'H x 70'L	400 lbs.	\$3,995 each	PROTF-55	12'H x 55'L	350 lbs.	\$3,695 each
-----------------	-------------	----------	---------------------	-----------------	-------------	----------	---------------------

All Tunnel Frames & Nets ship via Truck

TUNNEL NETS

All-Star Series Tunnel Nets (Nylon)

Most Popular for ceiling suspended cages. #36 thread count UV protected. 1-3/4" square mesh. Black, twisted knotted nylon. 3/8" twisted poly rope borders.

BBC36-7014	12'H x 14'W x 70'L	125 lbs.	\$1,699 each
BBC36-7012	12'H x 12'W x 70'L	118 lbs.	\$1,649 each
BBC36-5514	12'H x 14'W x 55'L	90 lbs.	\$1,449 each
BBC36-5512	12'H x 12'W x 55'L	85 lbs.	\$1,399 each

Major League UV Stabilized Tunnel Nets

#42 thread count, 1-3/4" square mesh, black knotless nylon netting, UV stabilized.

BBC-470	12'H x 14'W x 70'L	160 lbs.	\$1,299 each
BBC-370	12'H x 12'W x 70'L	130 lbs.	\$1,249 each
BBC-270	12'H x 14'W x 55'L	32 lbs.	\$1,049 each

Pro Climatized Tunnel Nets

#42 thread count. 1-3/4" square mesh. 2.5mm polyethylene filament fiber. Best filament for outdoor use. Twisted knot construction will not run if cut. High abrasion resistant. Roped perimeter & corners.

BBCP-7014	12'H x 14'W x 70'L	125 lbs.	\$1,099 each
BBCP-7012	12'H x 12'W x 70'L	118 lbs.	\$949 each
BBCP-5514	12'H x 14'W x 55'L	90 lbs.	\$849 each
BBCP-5512	12'H x 12'W x 55'L	85 lbs.	\$799 each

Collegiate Climatized Tunnel Nets

#24 thread count. 1-3/4" square mesh. 2.0mm polyethylene filament fiber. Same features as our Pro series, but for youth.

BBCC-7014	12'H x 14'W x 70'L	78 lbs.	\$849 each
BBCC-7012	12'H x 12'W x 70'L	72 lbs.	\$799 each
BBCC-5514	12'H x 14'W x 55'L	71 lbs.	\$749 each
BBCC-3514	12'H x 14'W x 35'L	45 lbs.	\$479 each



Pitcher's Safety Protector
 Versatile 7' x 7' "L-Shape" design accommodates left or right-hand pitchers. Works with pitching machine or live arm delivery. Use in or out of the batting tunnel. Details on page 53.



Cage Saver Target

This 6'H x 5'W heavy duty tarp is made of 40 oz. reinforced vinyl. Brass grommets along edges ensures a tight fit. Black vinyl with white strike zone. Includes two straps with clips to hang. Does not ship from Jaypro's CT warehouse. Call for freight quote.

CST65	11 lbs.	\$165 each
--------------	---------	-------------------





BBTF-70

Semi-Permanent Outdoor Batting Tunnel Frames

Economic and durable. Constructed of 2" O.D. galvanized steel tube. Net hangs on 3 rows of 3/16" galvanized aircraft cable. Includes ground sleeves. Accommodates both 12' and 14' wide nets. (Nets sold separately).

BBTF-70 - 5 wickets	12'H x 70'L	250 lbs.	\$1,989 each
BBTF-55 - 4 wickets	12'H x 55'L	225 lbs.	\$1,749 each

Surface Mounted Outdoor Batting Tunnel Frames

Same construction as our Semi-Permanent Outdoor Batting Tunnel Frames, but frames have integral 6" x 6" mounting plate for surface mounted installation. (Nets sold separately).

BBTFSM-70 - 5 wickets	12'H x 70'L	250 lbs.	\$2,195 each
BBTFSM-55 - 4 wickets	12'H x 55'L	225 lbs.	\$1,895 each

All Tunnel Frames & Nets ship via Truck

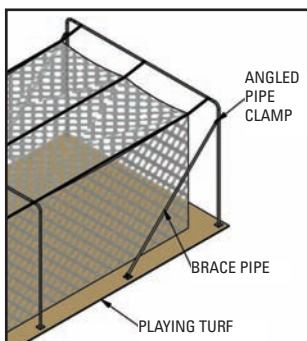

BBTF-BRKIT

BBTF-BRKIT

150 lbs.

\$595 kit

Only for use with 1.9" O.D. frames.

Secure all 4 corners!

Batting Tunnel Frame Brace Kit

Add diagonal braces to the end frames of your wicket style tunnel frame. Provides added support to prevent end frames from bowing in due to cable tension. **Includes 4 braces, fittings and attachment hardware for 2" O.D. pipe.** Works with either semi-permanent or surface mounted installations.

Batting Mat with Lines

6' L x 12' W. Inlaid white lines. Available in green or red clay. Indoor/Outdoor use. Spike-resistant artificial turf with throw down home plate. Thick foam backing. Does not ship from Jaypro's CT warehouse. Call for freight quote.

BML612G	Green	57 lbs.	\$429 each
BML612CL	Red Clay	57 lbs.	\$429 each

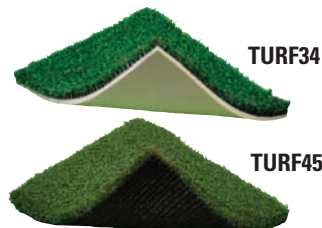

Batting Tunnel Turf

Artificial turf available by the roll. Used for batting cage floors, dugouts, baselines, bullpens, coaches boxes, walkways, etc. Excess turf may be trimmed in the field. All turf is green and sold by the square foot. Minimum roll length is 70'. Does not ship from Jaypro's CT warehouse. Call for freight quote.

TURF34 is a 34 oz. turf with 5 mm foam backing available in 12' wide rolls

TURF45 is a 45 oz. turf with unitary backing available in 15' wide rolls

TURF34	\$4.19 square foot		TURF45	\$4.49 square foot
---------------	---------------------------	--	---------------	---------------------------



BBC-700M

**Ceiling Suspended Retractable Batting Cage***

Motorized retractable batting cage. Easily raises and lowers from the ceiling using a drive shaft powered by a 1 HP electric winch, key switch operated. Size is 10'H x 12'W x 70'L. Frame is constructed of heavy walled 2" aluminum tube. Net included. To complete your installation, order one of the ceiling mounting kits below.

* 14' wide and other size cages also available!

BBC-700B Baseball 675 lbs. **\$5,895 each**

BBC-700M Multi-Sport 675 lbs. **\$6,595 each**

**Kit A**

Direct Attached: For cages centered directly beneath a beam or bar joist (system will be attached directly to single beam or bar joist).

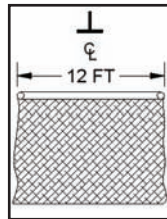

BBC-UBKIT

\$329 each

Kit B

Spanning Parallel 5 ft on center or less: For cages whose centerline is located between two beams or bar joists that are spaced 5 ft apart or less.

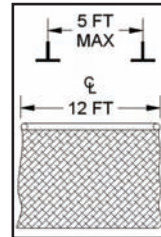

BBC-UP5KIT

\$639 each

Kit C

Spanning Parallel 5 ft to 8 ft on center: For cages whose centerline is located between two beams or bar joists that are spaced greater than 5 ft but not over 8 ft apart.

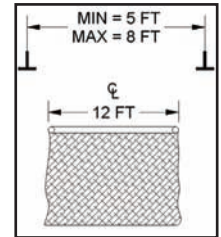

BBC-KIT58

\$1,395 each

Kit D

Spanning Perpendicular not greater than 8 ft on center: For cages oriented perpendicular to beams or bar joists that are spaced no greater than 8 ft apart.

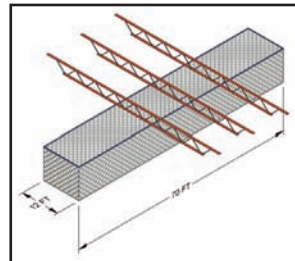

BBC-PERPKIT

\$2,395 each

Kit E

Peaked or Rigid Frame Building: (call for pricing). For cages being placed in a peaked rigid frame building. Drive supports to be chained down from roof purlins with rigid winch support.

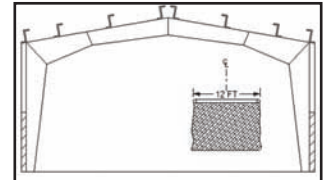

BBC-RIGKIT

Call for Pricing

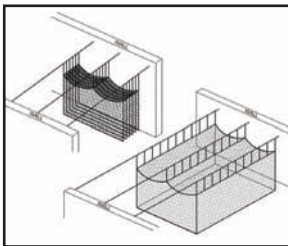
Thicker Cable + More Attachment Hardware = Better Quality!**Cable Suspended Tunnel Kit**

Maximizes your over-head space when net is in stored position. Allows support cables to be placed higher in the ceiling, up to 30 ft. Net is suspended on 1/8" aircraft cable every 3 ft on center. (nets & wall attachments sold separately, see below).

BBC-SPDKT

\$929 each

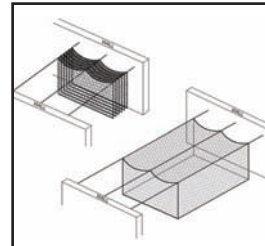
**Cable Supported Tunnel Kit**

Net attaches directly to cables that run from wall to wall. Attachment every 1'! Net slides easily against the wall for storage. Consists of (3) 100 ft rolls of 1/4" galvanized aircraft cable, plus all necessary hardware. (nets & wall attachments sold separately, see below).

BBC-SPRTKT

\$549 each

Wall Mounting Kit

(6) finished wood pads and steel mounting plates to attach to concrete, block or steel framed walls. Wall anchors not included. To be supplied by installer depending on wall specifications.

BBC-WLKT

\$599 each

Replacement Indoor Tunnel Nets

BBC36-7012 #42 1-3/4" square mesh, black knotted nylon netting, UV stabilized (12'H x 12'W x 70'L)



\$1,649 each

BBC-700N #252 3/4" square mesh, knotless nylon netting, UV stabilized (11'H x 12'W x 70'L)

\$2,495 each



Athletic Field Covers Available!

Assorted size Field Covers, Rolling Tubes and Fitted Sideline Covers are available.

Visit www.jaypro.com or call customer service for details.

Weighted Spot Covers

Covers that don't require any stakes or sandbags! 6 oz. polyethylene with weighted hem. Silver/White. Does not ship from Jaypro's CT warehouse. Call for freight quote.



Model	Description	Price
WWMC18	Mound Cover 18' - round	\$589
WWMC20	Mound Cover 20' - round	\$685
WWMC26	Mound Cover 26' - round	\$899

Pitcher's Mound, Home Plate, and Base Covers

Lightweight, durable covers to protect your field's dirt areas. Rip resistant 6 oz woven polyethylene covers are heat sealed to ensure waterproof protection. Grommets are at 3'-4" intervals. **2 Year Prorated Warranty** against breakdown from UV sunlight. Stakes included. Does not ship from Jaypro's CT warehouse. Call for freight quote.

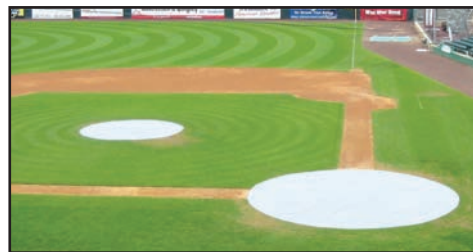
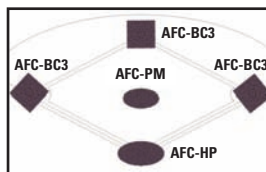

Color Silver/White (reversible)



Model	Description	Dimensions	Price
AFC-PM	Pitcher's Mound (including 7 stakes)	20' Round	\$255
AFC-HP	Home Plate (includes 9 stakes)	26' Round	\$359
AFC-BC3	Bases-Set (includes 15 stakes)	10' x 10' set of 3	\$235



Armor Mesh Windscreen

14 oz. woven, extrusion vinyl coated polyester mesh available 6' or 9'H. Fabricated with IncrediSeal™ heat sealed hem providing a clean look and eliminating the risk of stitches or seams coming undone! Provides 75% shade. Wind vents and cable ties sold separately. Colors shown below. **5 Year Warranty**. Does not ship from Jaypro's CT warehouse. Call for freight quote.

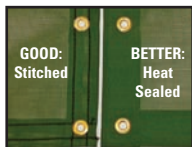

Heat sealed hem for extra durability

WSCRN-6	6' height	\$0.89 square foot
WSCRN-9	9' height	\$0.99 square foot

TuffPrint Lettering and Logo's
WSCRNLG Call for details and pricing



TWS-6



Dugout Canopy

Classic Wind Screen

An attractive yet economical wind screen that will meet all of your privacy, wind and background needs. Can also be used as a dugout canopy! Open mesh 8.2 oz/sq yd PVC coated polyester provides up to 84% shade. Includes reinforced hems and rust resistant grommets spaced at 18" intervals. Wind screens higher than 6' require a centered, horizontal lacing lip along the entire length. 18" dia. half moon wind vents are recommended to allow for wind passage, purchased separately. Plastic cable ties for installation are purchased separately. Comes in 6' or 9' high. **3 Year Warranty**. Colors shown below. **Customize your windscreen**. Does not ship from Jaypro's CT warehouse. Call for freight quote.

Item	Description	Price
TWS-6	6' High Screen	\$.69 sq. ft.
TWS-9	9' High Screen	\$.72 sq. ft.
PCT-100	Plastic Cable Ties	\$11 set of 100
HMV-18	Half Moon Wind Flap	\$3.45 ea



Note: maximum length of a single piece wind screen is 100'. Screens over 100' will be made in sections.

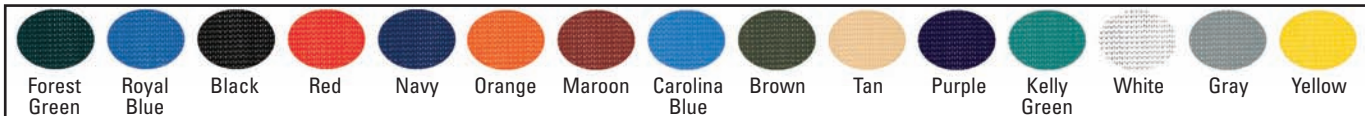



"Professional" Foul Poles

One Piece Welded Wing Panel Construction!
Tough powder coated finish in brilliant yellow.

These Foul Poles are designed to withstand up to 120 mph winds.

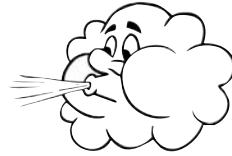

20' Professional Foul Pole

One piece welded steel construction designed for permanent, semi-permanent or surface mount installation. Main upright is 3-1/2" O.D. SS 40 zinc coated steel tubing. 18"W x 12'H fully welded wing panel includes heavy duty 1-1/2" x 13 gauge expanded metal mesh, designed to optimize air passage. See page 59 for optional ground sleeves for semi-permanent installation.

BBFP-20

570 lbs.

\$2,395 pair



BBFP-20SM

570 lbs.

\$3,195 pair

30' Professional Foul Pole

Two piece telescoping design for permanent, semi-permanent or surface mount installation. Main upright is 5.0" O.D. Schedule 40 zinc coated steel tubing. Upper frame consists of a top upright made from 4.0" O.D. 8 gauge zinc coated tubing, with a fully welded wing panel constructed from 2.0" steel tube. 18"W x 18'H wing panel includes heavy duty 1-1/2" x 13 gauge expanded metal mesh, designed to optimize air passage. See page 59 for optional ground sleeves for semi-permanent installation.

BBFP-30

850 lbs.

\$3,995 pair



BBFP-30SM

850 lbs.

\$4,495 pair

Over 30' Professional Foul Pole

Please call Customer Service with your specifications, wants and needs. Permanent, semi-permanent or surface mounted options available.

Call Customer Service for details



Surface and Wall Mount Installation is Available on our entire line of Foul Poles!

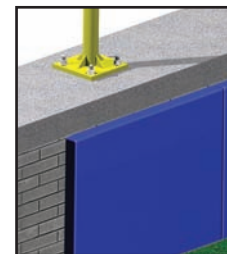

Outfield Distance Markers

Outfield distance markers are printed digitally with 13 oz. reinforced vinyl fabric. Available with numbers and background colors of your choice (specify colors when ordering). Banner colors: forest green, red, yellow, royal blue, gray, tan and black. Font colors: white, yellow, black and blue. 27" x 36" banner available with 14" numbers. 38" x 56" banner available with 24" numbers. Does not ship from Jaypro's CT warehouse. Call for freight quote.

ODM-23

27" x 36" Marker

\$120 each

ODM-35

38" x 56" Marker

\$130 each

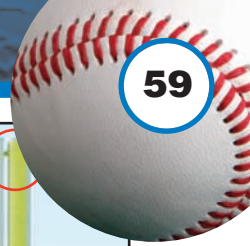

Collegiate Foul Poles

Tough powder coated finish in brilliant yellow, making it easy to see day or night



Collegiate 30' Foul Pole

Two piece telescoping pole. Base pole is 4-1/2" O.D. heavy walled steel tubing with 4.0" O.D. upper pole 18"W x 18"H bolt-on wing panel is all steel expanded metal. Tough powder coated finish over zinc undercoating. Designed for permanent or semi-permanent (with optional sleeve) installation. When installed, pole is 30 ft. above ground.

BBCFP-30

650 lbs.

\$2,495 pair



Collegiate 20' Foul Pole

Heavy duty 3-1/2" O.D. Steel upright with 18"W x 12"H wing panel. Bolt-on wing panel is all steel expanded metal. Tough powder coated finish over zinc undercoating. Designed for permanent or semi-permanent (with optional sleeve) installation. When installed, pole is 20 ft. above ground.

BBCFP-20

300 lbs.

\$1,449 pair



12' Baseball/Softball Foul Pole

Give your field a Major League look without the cost. Heavy duty steel 3-1/2" O.D. main post with 18"W x 6"H wing panel. Bolt-on wing panel is all steel expanded metal. Tough powder coated finish over zinc undercoating. Designed for permanent or semi-permanent (with optional sleeve) installation. When installed, pole is 12 ft. above ground.

BBSBFP-12

200 lbs.

\$969 pair

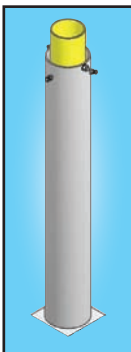
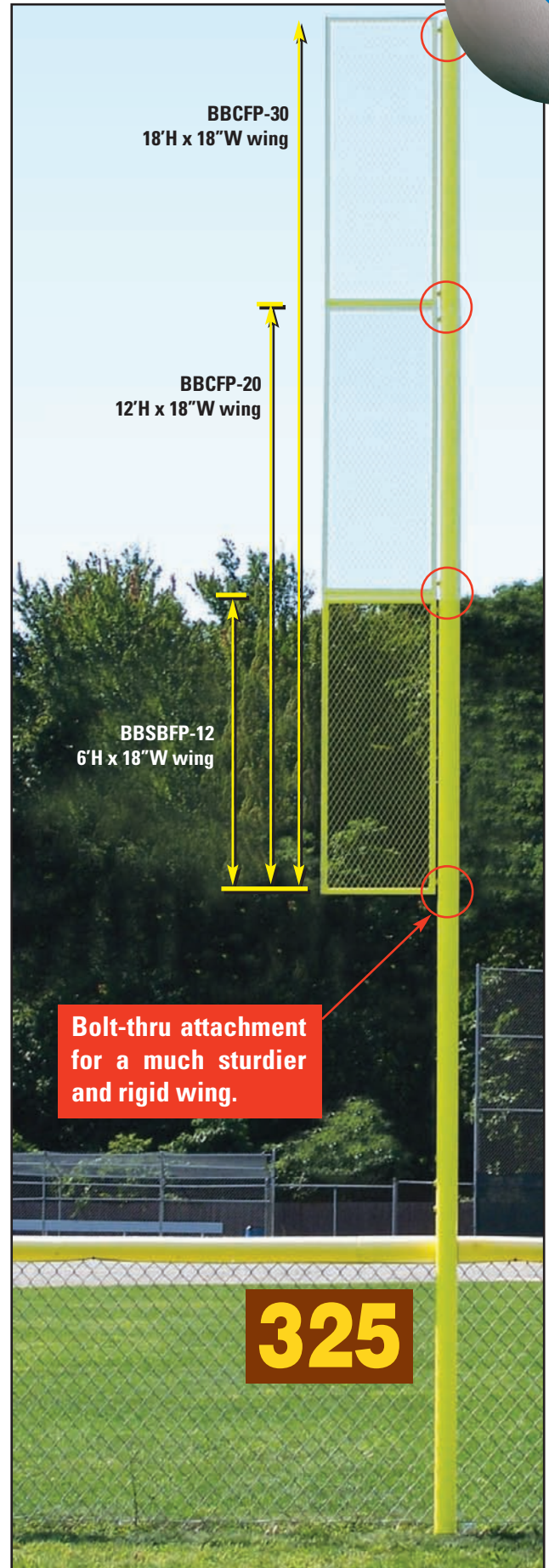

Optional Foul Pole Ground Sleeves

For semi-permanent installation of foul poles. Facilitates installation and maintenance.

FPS-12 12' Foul Pole Sleeves 18 lbs. **\$219 pair**

FPS-20 20' Foul Pole Sleeves 24 lbs. **\$259 pair**

FPS-30C 30' Foul Pole Sleeves 36 lbs. **\$289 pair**
for BBCFP-30 only

FPS-30P 30' Foul Pole Sleeves 40 lbs. **\$449 pair**
for BBFP-30 only



BB-200

"Flex" Style Bases*

Ideal for recreational play or competition. 15" x 15" x 3". Shock absorbing and compresses on impact. Includes three impact bases, three anchors and three 1-1/2" solid rubber plugs.

BB-200

33 lbs.

\$219 set*** Includes Anchors and Plugs!**

BB-500

Best Seller!**Pro-Style "Hollywood" Bases***

The highest quality, longest lasting base available. 15" x 15" x 3". Used by professional baseball players. Tapered lip digs into the dirt. Recommended for advanced levels of play only. Bases do not compress. Includes three bases, three anchors and three 1-1/2" solid rubber plugs. See page 62 to package with a Base Cart and save money!

BB-500

39 lbs.

\$199 set

Fully compliant with Little League® Rule 1.06!

BB-700

"Breakaway" Style Base Set

Fully compliant with Little League® Rule 1.06! Quick release base disengages from stationary rubber base plate upon impact. Official size 15" x 15" x 3". Set includes three base covers, three rubber base plates and three 1-1/2" anchors.

BB-700

39 lbs.

\$299 set

BB-600

"Bolco" Style Bases*

Official 15" x 15" x 3". Heavy-duty injected vinyl cover with bonded polyester foam core. Set includes three bases, bolt on plates and 1" anchors.

BB-600

28 lbs.

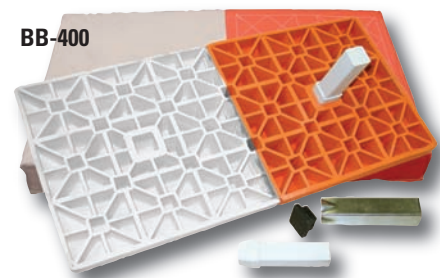
\$225 set

BB-400

Double First Base*

Reduces collisions. Compresses upon impact. 30" x 15" x 3". Features a double anchoring system. Includes double first base with two anchors and two 1-1/2" solid rubber plugs.

BB-400

26 lbs.

\$149 each*** Includes Anchors and Plugs!**

BB-150

Double Recreation First Base

30" x 15" x 3". Foam filled with nylon quilted cover. Includes straps and three spikes.

BB-150

5 lbs.

\$49 each

HP-300

BB-350

Rubber Throw Down Home Plate & Bases

Heavy-duty, molded rubber. Waffle bottom. Bases are 13-1/2" square and 1/2" thick.

HP-300

Home Plate 7 lbs.

\$16 each

BB-350

Bases 9 lbs.

\$38 set of 3

BB-100

Official Size Economy Bases

15" x 15" x 3". Foam filled bases with heavy-duty, quilted covers. Includes three bases with two nylon straps and two steel anchors per base.

BB-100

10 lbs.

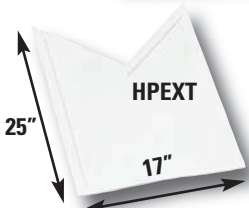
\$54 set

HPEXT

Home Plate Extension

Provides an extended strike zone, making it more visible for umpires to make the call. Made from white molded vinyl.

HPEXT

2 lbs.

\$19 each

BB-50

Throw Down Bases

For indoor or outdoor use. Flexible, washable rubber. Set includes three bases, home plate and a pitching rubber.

BB-50

5 lbs.

\$16 set

Visit www.jaypro.com or call Customer Service for Details and Information on other types of Bases.





HP-250

HP-200

Best Seller!

Major League Home Plate
High durability, molded rubber construction. Stanchion mounted steel plate. Easily removed for maintenance or storage. Comes with sleeve or five removable zinc-plated spikes.

HP-200 Plate with 1-1/2" Anchor 16 lbs. **\$99 each**

HP-250 Plate with Spikes 16 lbs. **\$129 each**

HP-50

Economy Home Plate
High durability, molded rubber construction with five removable spikes.

HP-50 10 lbs. **\$33 each**

HP-100

Bury-All Home Plate
High durability, all rubber construction. No corners or edges to catch spikes. Non-skid rubber surface. Waterproof.

HP-100 24 lbs. **\$89 each**

HP-150

Bury-All Home Plate
High durability, wood filled construction. No corners or edges to catch spikes. Non-skid rubber surface. Waterproof.

HP-150 29 lbs. **\$99 each**

48 HOUR QUICK SHIP
ENTIRE PAGE

Best Seller!

Professional Pitching Rubber
Major league size: 6" x 24". High-durability molded rubber exterior. Interior PVC tube provides maximum longevity. Fill with dirt or concrete for the most stable, rugged four-sided pitching rubber available.

PR-624 20 lbs. **\$99 each**

Step Down Pitching Rubber
Official size - 24" long. Step down style for better footing. Reduces pitcher's mound maintenance. Heavy-duty, all rubber construction or wood filled.

PR-524 19 lbs. **\$82 each**

Best Seller!

A. Removable Pitching Rubber
Official 24" size or Youth 18" size. For use on diamonds where various levels of play may require different pitching distances. Includes ground anchors made of heavy duty steel.

PR-424 Official 14 lbs. **\$79 each**

PR-418 Youth Size 10 lbs. **\$76 each**

Professional Pitching Rubber
Little League size - 18" long.

PR-618 10 lbs. **\$76 each**

Step Down Pitching Rubber
Little League size - 18" long

PR-518 10 lbs. **\$67 each**

Step Down P.R. 24" L Wood-Filled

PR-550 19 lbs. **\$92 each**

B. Movable Pitchers Plate with Spikes
Heavy molded rubber. Include three removable metal spikes. Official size and Youth 18" size.

PR-324 Official 10 lbs. **\$20 each**

PR-318 Youth Size 10 lbs. **\$17 each**

Combine and Save!



48 HOUR QUICK SHIP

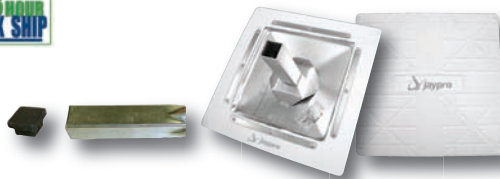

StackMaster™ Professional Base Package

Save money with this package! Get the base cart along with our Pro-Style "Hollywood" bases (BB-500). These bases are the highest quality, longest lasting available! To add a dig-out tool, see below.

BCARTSET 72 lbs. **\$339 each**

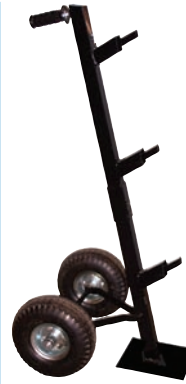

StackMaster™ Professional Base Cart

Simplifies transporting and storage of heavy pro bases. Heavy duty square steel frame and pneumatic tires. Positions bases for easy cleaning and touch up. Stores both male and female style base receptacles. Easy assembly. Cannot be used with BB-200 or BB-400 bases.

BBBCART 33 lbs. **\$199 each** 48 HOUR QUICK SHIP

Pre Assembled Recycled Rubber Base Anchor Foundation

The fastest, easiest way to install base anchors! Pre-assembled anchor foundation comes ready to install. Includes female anchor. Fits 1-1/2" anchors. Not designed for Bolco bases. Available individual or in sets of three. Does not ship from Jaypro's CT warehouse. Call for freight quote.

Designed for Hollywood and Magnetic style bases:

PABF1 Individual Base 3 lbs. **\$59 each**

PABF3 Set of 3 9 lbs. **\$155 set**

Designed for Bolco style bases:

PABF1-B Individual Base 3 lbs. **\$65 each**

PABF3-B Set of 3 9 lbs. **\$160 set**

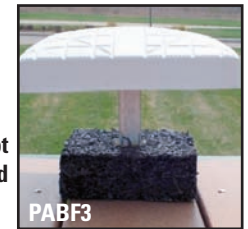

Base not included

PABF3

Base Rubber Plugs

BB-PLUG 1 lb. **\$5 each**

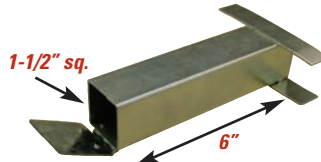
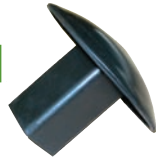

Base Anchors

BB-ANCHOR 1 lb. **\$9 each**

Base Dig-Out Tool

BB-DIGOUT 1 lb. **\$9 each**



Use for both 1-1/2" and 1-3/4" sleeves!

Big League Base Plug

BB-BLBP 1 lb. **\$12 each**



Replacement Anchor Plug

BB-RAP 1 lb. **\$7 each**

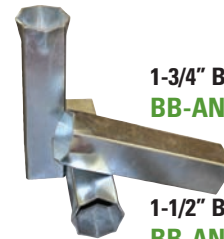

1-3/4" Base Anchors - Set of 3

BB-ANCHOR175 3 lbs. **\$35 set**

1-1/2" Base Anchors

BB-ANCHOR150 1 lb. **\$11 each**

1-3/4" or 1-1/2" sq.

StackMaster™ Batting Helmet Storage Rack

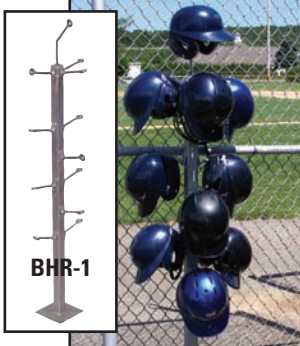

BHR-1

48 HOUR QUICK SHIP



PBR-14

Permanent Bat Rack

Heavy duty galvanized steel bat rack. Holds up to 14 bats. Permanently mounts directly to dugout surface.

PBR-14 33 lbs. **\$159 each**

Space saver in the dug out. Gets helmets stored properly for ready use. Store up to 12 helmets. Galvanized steel frame for long time outdoor use. Anchor to ground for secure installation.

BHR-1 28 lbs. **\$179 each**

Deluxe Batting Tee

Exceptionally durable construction for years of quality performance. Includes official size rubber home plate. Approximate telescoping adjustment height is 22" to 37". Ball not included.

BT-4 11 lbs. **\$35 each**



BT-4



BT-1

48 HOUR QUICK SHIP

Super Batting Tee

Ideal for all ages and abilities! Durable rubber construction features a heavy weighted rubber base with steel insert for added weight. Approximate telescoping height is 22" to 37". Ball not included.

BT-1 12 lbs. **\$28 each**

NEW VOLLEYBALL SOCCER FOOTBALL LACROSSE BASEBALL FIELD MARKING SCOREBOARD BASKETBALL GYMNASIUM FIELD SEATING BALL STORAGE PHYS. ED. TENNIS



Pitching Machines



HABPM-100

HACK ATTACK™



HABPM-100JR

JUNIOR HACK ATTACK™

Hack Attack Baseball/Softball Pitching Machine

The Hack Attack is designed for all levels of play; College, High School, Youth League and even the Major Leagues. Features a unique 3 wheel design that changes the breaking pitch plane by the turn of a dial. Underhand feeding motion, acceleration and release emulates a live pitcher. Dial-in pitch selection without head adjustments maximizes practice time. Choose from fastballs, risers, drops, right and left handed screwballs. Pivots instantly for pop-ups, fly balls and grounders. Speeds 35-100 mph and has a distance of 43 feet. Power supply 110 VAC - 2000W generator with inverter technology (not included). Works with all ball types including leather. Comes fully assembled.

Baseball

HABPM-100 135 lbs. **\$3,499 each**

Softball

HASPM-200 135 lbs. **\$3,499 each**

Hack Attack Junior Baseball/Softball Pitching Machine

Same features as the Hack Attack, except this is designed for younger players. Speeds from 35-70 mph.

Baseball Junior

HABPM-100JR 75 lbs. **\$2,399 each**

Softball Junior

HASPM-200JR 75 lbs. **\$2,399 each**



BCT-100

Baseball Cart

Heavy duty 1½" O.D. powder coated steel frame. Large capacity basket 17"W x 24"D x 16"H holds hundreds of baseballs or softballs. Oversized 14" never-go-flat tires for easy transport.

BCT-100 35 lbs. **\$199 each**



Little League Game Mound (PPM-69)

TRUE PITCH OFFICIAL GAME MOUNDS

Mounds (official size) are portable and can be carried by 2 people. Quality constructed. Made of reinforced fiberglass shell covered with durable artificial turf. Pitching rubber included. The tapered sharp edge makes a smooth transition to your existing field. Use with turf shoes only - no cleats. Does not ship from Jaypro's CT warehouse. Call for freight quote.

Model	League	Ages	Dimensions	Weight	Price
PPM-69	Little	9-12	6'10"W x 9'2"L x 6"H	180 lb/ea	\$3,039
PPM-810	Pony	12-15	8'W x 10'L x 8"H	220 lb/ea	\$3,549
PPM-1012	Senior	15 & Up	10'W x 12'6"L x 10"H	340 lb/ea	\$4,499



Call for freight quote. All True Pitch Mounds have a fiberglass base with a **Limited 3 Year Warranty** - no warranty on turf.



PPM-95G



Mound Caddy included!

ProMounds Collegiate & ProModel Mounds with Turf

Made of heavy duty foam with skid proof rubber armor that will not damage floors. Can be used indoors or out. Improved reinforced back end for added durability. Made of spike-proof turf and available in two sizes (Professional: 9'L x 5'W x 10"H or Collegiate: 9'L x 4'W x 10"H). Includes a mound caddy and recessed tape measure to measure distance from home to rubber. Available in green or red clay. Does not ship from Jaypro's CT warehouse. Call for freight quote.

Professional: 9'L x 5'W x 10"H

PPM-95G Green 125 lbs. **\$1,349 each**

PPM-95CL Clay 125 lbs. **\$1,349 each**

Collegiate: 9'L x 4'W x 10"H

PPM-94G Green 100 lbs. **\$1,249 each**

PPM-94CL Clay 100 lbs. **\$1,249 each**



PPM-95CL



ST75PC

Scorers Table

Top quality, aluminum scorers table. 7.5'L x 10"W Aluminum seat and 19" wide table top. 2" x 2" heavy-duty galvanized steel legs for superior rust resistance. Same high quality as our full line of player benches. **Powder coat your table for a custom look!** Please specify plank and leg color choice/s when ordering.

Length	Natural Finish	Natural Finish Price	Powder Coated	Powder Coated Price	Weight
7-1/2'	ST75	\$489	ST75PC	\$579	90 lbs.

48 HOURS
QUICK SHIP**Batter's Box Template**

Aluminum frame lightweight template for quick and easy striping of batters boxes. Foldable for easy storage and transport. Carry handle aligns with home plate for proper positioning. Frame leaves 2" pattern for chalking. Available in three sizes: Official, Little League or Softball.

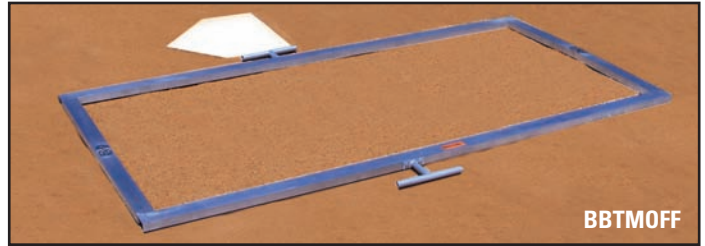
Official 4'x6'**BBTMOFF** 29 lbs. **\$269 each****Little League 3'x6'****BBTMLL** 28 lbs. **\$249 each****Softball 3'x7'****BBTMSB** 29 lbs. **\$249 each**

BBTMOFF



MSG-1

Mound Slope Gauge

Alignment gauge made of one-piece, heavy duty aluminum. A bubble level is attached for proper leveling. Includes metal ruler for measuring mound slope drops. Two support rods included, one is adjustable for leveling the gauge. Stores easily in PVC container, which it also ships in. Includes complete instructions for mound slope construction and maintenance. Assembly required to install handle and braces. Does not ship from Jaypro's CT warehouse. Call for freight quote.

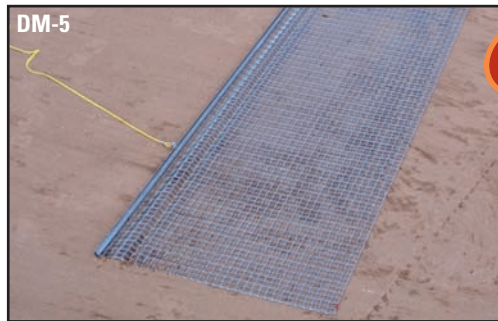
MSG-1 12 lbs. **\$249 each**

DM-5

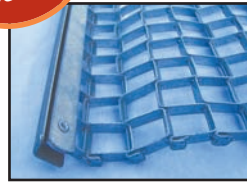
Best Seller!48 HOURS
QUICK SHIP**Infield Drag Mat**

Flexible plated steel mesh mat with 1-5/16" galvanized steel drag bar and a 3/8" polypropylene rope handle. Available in 3', 5' and 6' widths. **18 Month Warranty.**

DM-5 3'D x 5'W 27 lbs. **\$149 each****DM-34** 4'D x 3'W 21 lbs. **\$129 each****DM-63** 3'D x 6'W 33 lbs. **\$219 each****DM-6** 6'D x 6'W 65 lbs. **\$329 each**

DL6

Drag Lite

Offers an adjustable scarifier blade that breaks up hard surfaces and then grooms to a "ready to play" condition. 10' heavy-duty pull chain. Available in either 3' or 6' wide. 3' model can be pulled comfortably by hand and 6' pulled by truck. **1 Year Warranty.** Does not ship from Jaypro's CT warehouse. Call for freight quote.

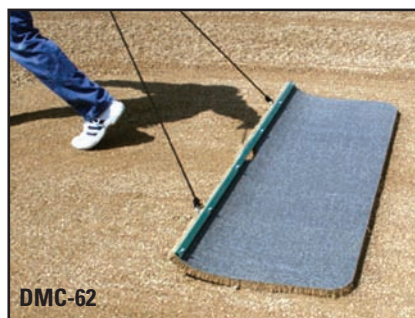
DL3 3' Wide 31 lbs. **\$229 each****DL6** 6' Wide 55 lbs. **\$349 each**

DMC-62

Cocoa Hand Drag Mat

Great for between innings! Similar to Infield version but 2' long and equipped with rope handle. Available in either 4' or 6' wide. Includes steel lead bar. **1 Year Warranty.** Does not ship from Jaypro's CT warehouse. Call for freight quote.

DMC-42 2'D x 4'W 25 lbs. **\$209 each****DMC-62** 2'D x 6'W 36 lbs. **\$259 each**

NDX-32

X-Drag Hand Nail Drag

Ideal for baselines, cutouts and home plate areas, as well as daily topdressing layer. Constructed of plastic lumber and hardened steel spikes. Size: 3' x 2' - can be pulled for 2' wide or 3' wide work. Pull rope included. Does not ship from Jaypro's CT warehouse. Call for freight quote.

NDX-32 35 lbs. **\$339 each**



Comes with a 12" Double Dipped Vinyl Grip on the Handle

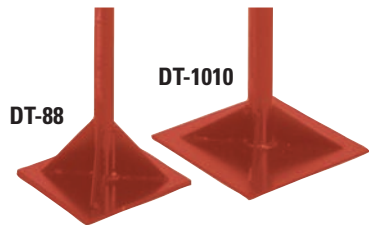

Dirt Tamp

Durable, all steel construction. Available in 8" x 8" or 10" x 10" size.

DT-88 8" x 8" 12 lbs. **\$83 each**

DT-1010 10" x 10" 15 lbs. **\$90 each**



Loop Hoe

60" powder-coated aluminum handle with 6" non-slip vinyl grip.

LH-60 2 lbs. **\$41 each**



Ideal for spreading top dressing!

Sifting Shovel

Perforated scoop sifts debris from all types of soils. Virtually indestructible. 42"L handle, 14" x 17" scoop.

SS42 5 lbs. **\$112 each**



Field Rake

The strongest and most durable rake available. Made of an aluminum/magnesium alloy. Large 36" or 42" grading edge with heavy-duty cleaning teeth. 66" lightweight, aluminum handle.

Best Seller!

FR-36 36" Field Rake 6 lbs. **\$72 each**

FR-42 42" Field Rake 6 lbs. **\$82 each**

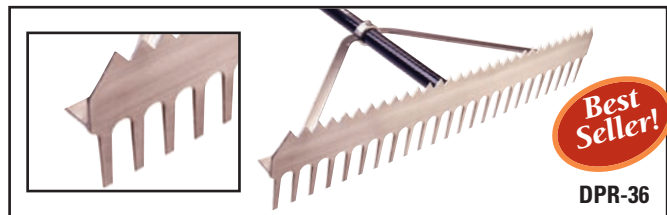

Double Play Rake

66" powder-coated aluminum handle w/5" non-slip vinyl grip, and high-grade aluminum head and bracing. Available in 24" or 36" head sizes.

Best Seller!

DPR-24 24" Double Play Rake 6 lbs. **\$83 each**

DPR-36 36" Double Play Rake 6 lbs. **\$88 each**

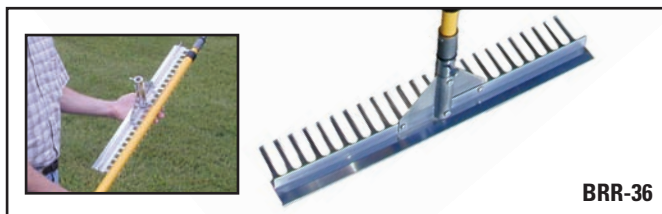

Base Runner Rake

Same as FR-36 but it includes a telescopic double locking fiberglass handle. This durable landscape rake is a great addition for your maintenance tools. Easily adjusts from 30" to 70". Breaks down for easy storage.

BRR-36 Base Runner Rake 5 lbs. **\$99 each**



Double Play Scarifier Broom

Aluminum powder coated blue handle, 28" head with scarifying edge and two rows of removable bristles.

DPSB-28 8 lbs. **\$145 each**



Monster Drag Broom

Heavy duty aluminum construction with 2 rows of removable bristles and massive 7' head. Foam covered handle.

MDB-84 13 lbs. **\$240 each**

Double Play Monster Drag Broom

Same as MDB-84 plus an aggressive scarifying edge on flip side.

DPMD-84 17 lbs. **\$269 each**

Visit www.jaypro.com for more Field Maintenance Products!

Temporary Fencing Available!

Also have One-Piece Kits for Softball, Little League and Baseball. Visit www.jaypro.com or call customer service for details.



CFC-250

Fence Top Protection

Reduce player injuries, increase visibility and field attraction. 4" diameter corrugated plastic pre-slit for easy installation to top fence rail. Secure with tie wraps every 2'. Ties are sold separately. Does not ship from Jaypro's CT warehouse. Call for freight quote.



CFC-ITOOOL

Installation tool makes installing quick and easy!



Yellow	Description	Price
CFC-100YW	100' Coil Fence Crown	\$179 each
CFC-250YW	250' Coil Fence Crown	\$259 each
CFC-TIESYW	19" Ties	\$47 / bag of 100
CFC-ITOOOL	Installation Tool	\$76 each



Safety Top Cap

An attractive fence top that also provides protection. Simply snap over the top of the fence and lock to the wire mesh with the included steel hog rings. Made of HDPE plastic with UV stabilizers. Includes five 8'L sections and 15 hog rings per set. Comes with a **25 Year Limited Warranty!** Does not ship from Jaypro's CT warehouse. Call for freight quote.

STC-8

Yellow

\$125 set



Safeoam for Railings and Tubing

Tubular foam padding has thick extra-durable skin coating. Comes in 8 ft. lengths and pre-slit for easy installation. Fits completely over any 2-1/8" diameter or less round pipe. Secure with tie wraps every 2'. Minimum of 6 pieces. Sold in 8' sections. Please specify yellow, royal blue, red or green. Ties are sold separately and include 100 ties per bag. **5 Year Limited Warranty.** Does not ship from Jaypro's CT warehouse. Call for freight quote.



Colors shown may not be an exact match.

Description	Yellow	Royal Blue	Red	Green	Price
Safeoam Tubular Padding	SF-PREMYW	SF-PREMRB	SF-PREMRD	SF-PREMGR	\$59 ea
19" Ties	SF-TIESYW	SF-TIESRB	SF-TIESRD	SF-TIESGR	\$42 bag

Use Safeoam Padding to protect your Pitching and Fielding Screens...



Deluxe Fence Top and Rail Padding

Ideal padding for dug-out railing and fence tops. 2" thick foam is encased in 18 oz. vinyl with grommets for attachment every 6". Sold in 6' long sections in your choice of colors: royal blue, forest green, red, gray, black and white. Please specify color when ordering. **1 Year Limited Warranty.** Does not ship from Jaypro's CT warehouse. Call for freight quote.



PRAFTP6

\$145 per 6' section



Great For Railings And Fence Tops!



Turn our Dry Line marker into a Combo Marker, both Wet and Dry applications!

NEW VOLLEYBALL SOCCER FOOTBALL LACROSSE BASEBALL FIELD MARKING SCOREBOARD BASKETBALL GYMNASIUM FIELD SEATING BALL STORAGE PHYS. ED. TENNIS



Fold in handles and handle frame for easy storage in tight spaces



48 HOUR QUICK SHIP
ENTIRE PAGE



FLMR-100HD shown with optional field accessories

Jaypro
XCLUSIVE

10" no-flat wheels

Dry Line Field Markers

All dry line field markers come with the following features: Handle mounted control levers for instant on/off gate opening. Precision control for 2" or 4" lines. Dual wheel drive ensures consistent feed, without slip. 18 gauge steel hoppers and frame. The FLMR-100HD and FLMR-50HD both come with a useful side mounted storage box for holding tools and field implements. Stainless steel hardware. Tough, powder coated forest green finish.

100 lb. Heavy Duty Field Marker

100 lb. capacity. **Jaypro Exclusive:** Four 10" no-flat wheels, easily handles any terrain! Dual heavy duty handles are comfortably spaced and sturdy. Handles fold inward for easy storage in tight spots. Entire handle frame folds forward for off-season storage. Heavy gauge steel plate framework is rugged and durable. Base frame contains access window for viewing of line as dispensed. Unit contains all necessary holes and openings to easily add optional aerosol spray kit.

FLMR-100HD 70 lbs. **\$369 each**

50 lb. Heavy Duty Field Marker

50 lb. capacity. Same construction and features as the FLMR-100HD (above).

FLMR-50HD 60 lbs. **\$339 each**

Two Wheel Field Marker

25 lb. capacity. Two wheels provide for easy maneuvering around home plate.

FLMR-25 20 lbs. **\$169 each**

Mini Dry Line Field Marker

Perfect for touch ups and small applications. 200 yard capacity (holds up to 10 lbs. of lime or chalk). Produces 2" wide lines.

FLMR-10 15 lbs. **\$94 each**

Refer to the next page to see how to convert this unit to a Combo Marker!

Combo Marker

Turn our 100 lb. and 50 lb. Dry Line Markers into Combo Markers with our Aerosol Spray Kit!



Optional Aerosol Spray Kit

Add spray capability to your dry line marker. Kit comes complete with applicator assembly, mounting brackets, air deflector and side mounted holding basket, which holds two aerosol cans. Easily installs in minutes.

FLMR-AKIT

7 lbs.

\$79 kit

Package Deal on Field Marking Equipment...



BASIC PACKAGE INCLUDES:

Dry Line Marker (FLMR-50HD, page 67)
Base Runner Rake (BRR-36, page 65)
Base Dig-Out Tool (BB-DIGOUT, page 62)
Pro Line Layout & Marking System (FM-LM1, page 69)
Official Batter's Box Template (BBTMOFF, page 64)

FMP-10FF

SAVINGS OF \$130

\$685 package

Same as above except with

Softball Batter's Box Template (BBTMSB, page 64)

FMP-1SB

SAVINGS OF \$125

\$670 package

Same as above except with

Little League Batter's Box Template (BBTMLL, page 64)

FMP-1LL

SAVINGS OF \$125

\$670 package



DELUXE PACKAGE INCLUDES:

All listed items for the Basic Package plus:
3' x 5' Infield Drag Mat (DM-5, page 64)
Mini Dry Line Field Marker (FLMR-10, page 67)
Wet Paint Adapter Kit (FLMR-AKIT, above)

FMPD-20FF

SAVINGS OF \$167

\$970 package

Same as above except with

Softball Batter's Box Template (BBTMSB, page 66)

FMPD-2SB

SAVINGS OF \$162

\$955 package

Same as above except with

Little League Batter's Box Template (BBTMLL, page 66)

FMPD-2LL

SAVINGS OF \$162

\$955 package



Athletic Field Marking Dust

Bright white premium marking dust complies with the NCAA rules for athletic marking dust. Used on baseball, softball, football, soccer or any athletic field. Officially approved. Economical. Harmless to skin, clothes and turf. Easy to apply. Does not ship from Jaypro's CT warehouse. Call for freight quote.

AFMD50

Pallet of 40 (50 lb. bags)

2060 lbs.

\$325 each





Folds down easily for storage!

FME-501

Best Seller!



Economy Paint Marker

Rugged, dependable striper. Aerosol paint sold separately. Folds down for storage. Easy to transport. Adjustable line width from 2" - 4". **Limited Lifetime Warranty!**

FME-501 28 lbs. **\$142 each**



NewRider™ Airless Riding Field Stripper

NEW

Ideal for sports complexes or schools and municipalities with multiple fields. Designed for natural or artificial turf with water or oil based paints. Fully adjustable .44 gpm, 0-3000 psi airless pump. Spray gun with reversible tip for 2"-6" lines and 25' hose. 10.5hp Briggs & Stratton engine with electric start. 25 gallon paint capacity and 2.5 gallon purge tank for easy clean up. **3 Year Warranty.** Does not ship from Jaypro's CT warehouse. Call for freight quote.

FM-AIRFS 600 lbs. **\$9,995 each**



FMWAND

Field Marking Wand

Marking straight lines is quick and easy. Holds one aerosol can.

FMWAND 5 lbs. **\$52 each**



EcoLiner™ Battery Powered Field Stripper

NEW

Ideal for striping one field at a time. Quickly and easily paint quality lines for hours on a single charge. Features heavy duty, 3 gpm, 0-45 psi diaphragm pump

powered by a 12 volt battery. 5 gallon pail paint capacity. Spray gun with 10' hose for line widths 2" - 6". Hand operated, handle mount controls. Equipped with quick charge 120V plug in battery charger, on-board clean water reservoir and no-flat tires. **1 Year Warranty.** Does not ship from Jaypro's CT warehouse. Call for freight quote.

FM-ECOBP 78 lbs. **\$1,095 each**



Self Propelled Airless Striping Machine

NEW

Self propelled, variable speed friction drive, dual handles with cushioned grips and all welded steel construction. 5 gallon paint capacity for water or oil based paints. Self propelled by a 126cc Subaru engine. Airless spray gun with reversible tip, 2-6" adjustable line width with 25' hose. Easy clean-up. **3 Year Warranty!**

FM-4600SP 230 lbs. **\$3,399 each**



Line Layout & Marking Systems

Pro Line Layout and Marking System

Use to mark your field for any sport! Quickly mark any size field. Measure once and easily re-stripe year after year. Includes locators, starting tool and 600' cord. Made of durable polypropylene plastic.

FM-LM1	12 piece Baseball Line Layout	\$99 kit
FM-LM2	15 piece Soccer Line Layout	\$219 kit
FM-LM5	50 piece Football Line Layout	\$369 kit
FM-LM4	14 piece Lacrosse Line Layout	\$69 kit
FM-LM0	6 piece Replacement Kit	\$159 kit



Aerosol Paints (with universal spray tip)

White (GL-101) Royal Blue (GL-107) Yellow (GL-108) Red (GL-110)

Other colors also available, visit www.jaypro.com. Does not ship from Jaypro's CT warehouse. Call for freight quote.

GL-101	White Only - (12) 18 oz. cans	18 lbs.	\$49 case
	All Other Colors - (12) 18 oz. cans	18 lbs.	\$59 case

Best Seller!

Buy in Bulk & Save White Only pallet of 60 cases

PNTPKG-1 Plus **FREE FREIGHT!!!** 1150 lbs. **\$2,569 each**



NEW VOLLEYBALL SOCCER FOOTBALL LACROSSE BASEBALL FIELD MARKING SCOREBOARD BASKETBALL GYMNASIUM FIELD SEATING BALL STORAGE PHYS. ED. TENNIS



NEW

Baseball/Softball Scoreboard

Ideal for Baseball and Softball fields. High visibility 18" LED digits: HOME, GUEST and INNING. 4" BALL, STRIKE, OUT, H & E. Rugged powder coated aluminum enclosures and removable panels for easy cleaning. See color chart. 2.4GHz integrated wireless. Wireless tabletop controller and an adjustable 8 tone 125db horn. **5 Year Limited Warranty.** Does not ship from Jaypro's CT warehouse. Call for freight quote. Size: 4'H x 9'W x 4-1/4"D

BBSBS-49 120 lbs.

\$3,195 each



NEW

Football Scoreboard

Ideal for any Football field. High visibility 24" LED digits: HOME, GUEST and TIME. 18" DOWN, TO GO, BALL ON, QTR & TOL. 10" Football image to show possession. Rugged powder coated aluminum enclosures and removable panels for easy cleaning. See color chart. 2.4GHz integrated wireless. Wireless tabletop controller and an adjustable 8 tone 125db horn. **5 Year Limited Warranty.** Does not ship from Jaypro's CT warehouse. Call for freight quote. Size: 7'6"H x 22'4"W x 4-1/4"D

FBS-722 900 lbs.

\$12,195 each



Basketball Scoreboard

Ideal solution for your gymnasium. High visibility 13" LED digits: HOME, TIME and GUEST. 10" PERIOD, FOULS, TOL and PLAYER-FOULS. 2" BONUS & POSSESSION DOTS/ARROWS. Rugged powder coated aluminum enclosures and removable panels for easy cleaning. See color chart. 2.4GHz integrated wireless. Wireless tabletop controller. **5 Year Limited Warranty.** Does not ship from Jaypro's CT warehouse. Call for freight quote. Size: 5'H x 9'W x 4-1/4"D

BSKS-59 150 lbs.

\$4,495 each



Multi-Sport Portable Scoreboard Package

Ideal for facilities offering multiple sports. High visibility 10" LED digits: HOME, TIME and GUEST. 7" PERIOD. 2" TIME OUTS LEFT DOTS. Rugged powder coated aluminum enclosures and removable panels for easy cleaning. See color chart. 2.4GHz integrated wireless and adjustable 8 tone 125db horn. Comes complete with Wireless hand held controller and portable caddy for easy transport. **5 Year Limited Warranty.** Does not ship from Jaypro's CT warehouse. Call for freight quote. Board: 2'4"H x 6'W x 4-1/4"D, Caddy: 5'6"W x 4'7"H x 2'7"D

MSPS-26PKG 255 lbs.

\$5,395 each



NEW

Lacrosse Scoreboard

Ideal for indoor or outdoor Lacrosse fields. High visibility 18" LED digits: HOME, GUEST, TIME and QUARTER. 13" PLAYER and PENALTY. 4" TOL DOTS. Rugged powder coated aluminum enclosures and removable panels for easy cleaning. See color chart. 2.4GHz integrated wireless. Wireless tabletop controller and an adjustable 8 tone 125db horn. **5 Year Limited Warranty.** Does not ship from Jaypro's CT warehouse. Call for freight quote. Size: 8'2"H x 11'W x 4-1/4"D

LXS-811 290 lbs.

\$8,295 each

Enclosure Color Choices

Colors displayed may not be an exact match



Use with Shot and Play clocks. Includes built in real time clock to keep time of day. Has an operating distance of up to 1,000 feet. Buttons with tactile done feedback and large transfective LCD screen. Supports external Run/Stop/reset switch to allow for additional clock operators. Power requirements: DC-5V, max 1.0 amp, from external power supply or PC. Internal rechargeable lithium-polymer battery. Does not ship from Jaypro's CT warehouse. Call for freight quote. Size: 12"H x 4"W x 9"D

WTTC-1 3 lbs.

\$725 each

NEW



Shot and Play Clock

Ideal for sports facilities. High visibility 13" LED digits. Rugged powder coated aluminum enclosures and removable panels for easy cleaning. See color chart. 2.4GHz integrated wireless with an adjustable 8 tone 125db horn. Controller purchased separately. Does not ship from Jaypro's CT warehouse. Call for freight quote. Size: 2'H x 1'9"W x 4-1/4"D

SPC-2 25 lbs.

\$2,995 set



Baseball



NEW

HABPM-100



Hack Attack Baseball Pitching Machine

The Hack Attack is designed for all levels of play; College, High School, Youth League and even the Major Leagues. Features a unique 3 wheel design that changes the breaking pitch plane by the turn of a dial. Underhand feeding motion, acceleration and release emulates a live pitcher. Dial-in pitch selection without head adjustments maximizes practice time. Choose from fastballs, risers, drops, right and left handed screwballs. Pivots instantly for pop-ups, fly balls and grounders. Speeds 35-100 mph and has a distance of 43 feet. Power supply 110 VAC - 2000W generator with inverter technology (not included). Works with all ball types including leather. Comes fully assembled.



NEW

HABPM-100JR



Baseball

HABPM-100 135 lbs.

\$3,499 each

Softball

HASPM-200 135 lbs.

\$3,499 each

Hack Attack Junior Baseball Pitching Machine

Same features as the Hack Attack, except this is designed for younger players. Speeds from 35-70 mph.

Baseball Junior

HABPM-100JR 75 lbs.

\$2,399 each

Softball Junior

HASPM-200JR 75 lbs.

\$2,399 each

Soccer



NEW

Strike Attack Soccer Machine

Battery powered machine provides reliable service on any soccer field or playing surface. A realistic curve and bend of the ball can be consistently delivered and easily controlled. Balls can be delivered at speeds up to 75 mph and distances of 70 yards or more. The type of spin, height and direction desired can be locked into place to ensure precise repetition focused on your specific training objectives.

SASM-1 250 lbs.

\$4,199 each

Football



NEW

Snap Attack Football Machine

The Snap Attack is a snap, pass and kick machine that will maximize your time on the most difficult to practice phases of the game. Features include universal ball feed cradle, elevation control and lever clamp combined with a locating pin to make changes from spirals to kick-offs easy and quick. Speeds of 70+ mph and distances of 100 yards for passes and punts, 70+ yards for kick-offs and 5-15 yards for snap-tight spirals. Ball release points at 5' for passes and ground level for snaps.

SAFM-1 90 lbs.

\$4,199 each

Volleyball



NEW

Attack II Volleyball Machine

The Attack II delivers thousands of reps in daily practice of serve receiving, digging and spiking. Accuracy and repeatability are assured in every drill, eliminating time-wasting errant hits. With a ball release point of 5'6" to 8'-6", it offers a full range of spins, throwing both sharp topspins and breaking floaters to simulate match situations. Spiking over Women's net at speeds up to 70 MPH. Fits through a standard doorway and into any standard size SUV or pick-up.

VBSA-2 190 lbs.

\$3,149 each

Attack II Ball Bag

Heavy duty canvas. Easily attaches and detaches to the Attack II model. Two recommended per unit. Each bag holds 15 balls.

VBSA-BAG

\$149 each



66" Play Safe Area

6" x 6"
POLEPole & Backboard Edge
Padding Included!

LD-200

LS-200



LS-200RS

The Playground

Upright and 5' 6" angled extension arm are constructed of 6" square steel. This fixed height unit buries 48" into the ground. Official size 42" x 72" Acrylic or Steel backboard. Height can be adjusted after court resurfacing or for kid's play. Heavy-duty flex goal with nylon net. **Pole and backboard edge padding included with the Acrylic board (LS-200), pole padding included with the Steel board (LS-200RS).**

LS-200	Acrylic Board	550 lbs.	\$2,295 each
LS-200RS	Steel Board	545 lbs.	\$2,295 each
LD-200	Double Board	850 lbs.	\$3,395 each



40" Play Safe Area

Pole Padding
Included!4" x 4"
POLE

400-FA-FG



400-AC-FG

The Church Yard

Upright and 40" angled extension arm are constructed of 4" square steel. This fixed height unit buries 48" into the ground. 36" x 48" Acrylic or 36" x 54" Fan Aluminum Backboard. Heavy-duty flex goal with nylon net. **Pole and backboard edge padding included. Fan backboard does not include edge padding.**

400-AC-FG	Acrylic Board	350 lbs.	\$1,395 each
400-FA-FG	Fan Aluminum Board	300 lbs.	\$1,349 each



Bolt-On Replacement Edge Padding for these units can be found on Page 81.



6" x 6" POLE

**42" Play Safe Area at 10'
53" Play Safe Area at 7'6"**

Pole & Backboard Edge Padding Included!

The Park

Upright is constructed of 6" square steel with a 40" double arm extension. This surface mount unit has a height adjustment range from 7'6" to 10'. Official size 42" x 72" Acrylic Backboard. Heavy-duty flex goal with nylon net. **Pole and backboard edge padding included.**

TSP-200

TSP-200 500 lbs. **\$2,395 each**

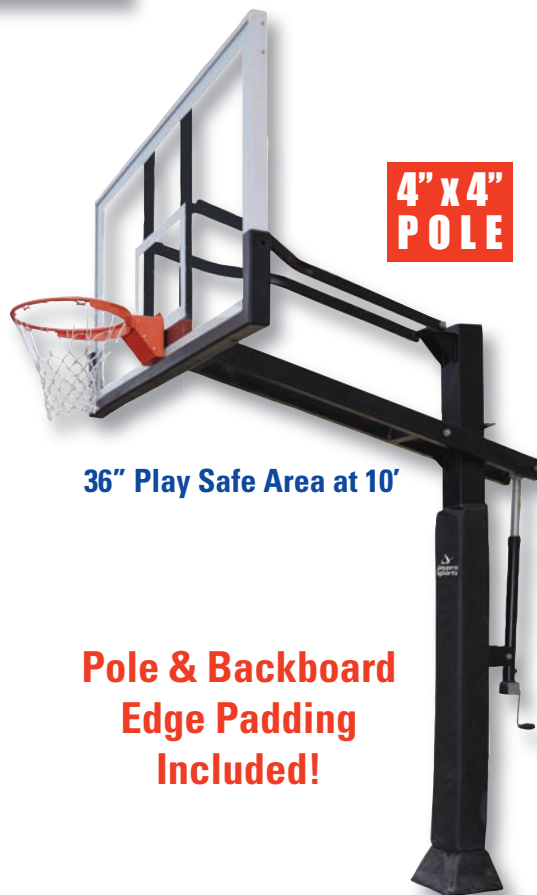

4" x 4" POLE

36" Play Safe Area at 10'

Pole & Backboard Edge Padding Included!

TSP-44

The Resident

Upright is constructed of 4" square steel with a 40" double arm extension. This surface mount unit has a height adjustment range from 7'6" to 10'. Official size 36" x 48" Acrylic Backboard. Heavy-duty flex goal with nylon net. **Pole and backboard edge padding included.**

TSP-44 350 lbs. **\$1,495 each**





Pole Padding
For 6" x 6" poles. 6'H x 2" thick black padding that attaches to pole with hook-and-loop closure.

PP-66 3 lbs. **\$189 each**

For 4" x 4" poles. 6'H x 2" thick black padding that attaches to pole with hook-and-loop closure.

PP-44 3 lbs. **\$149 each**

Hoop Rejuvenator™ Kits

Attach to your Existing Goosenecks



Is your playground basketball system leaning, rusted, or non-regulation height? Does your budget prohibit tearing out your old system and installing a new one?

Jaypro has the solution... Don't remove it – Improve it!

Upgrade your basketball system with Jaypro's new Patent Pending Hoop Rejuvenator™. Replace your rusted steel backboard and rejuvenate it back to regulation height without the added cost and aggravation of excavating your old gooseneck and replacing it.

- Choose either H-Frame design (shown) or Direct Mount
- Allows for adjusting the goal height after resurfacing. (Up to 6" on H-Frames and 5" on Direct Mount units)
- Plumbs boards on leaning goosenecks.
- Designed to fit all standard mounting plates and goosenecks, 4-1/2" O.D. and up. For 3-1/2" O.D. goosenecks use Aluminum Fan board only.
- Offered with Acrylic, Steel or Aluminum Fan backboards.
- All kits include our Ultimate Breakaway Playground Goal (UBG-500F).
- Includes Stainless Hardware and can of spray-on Zinc Galvanize to paint over rusted areas on the gooseneck.



Acrylic Board



Hoop Rejuvenator™ H-Frame Kit
42" x 72" Rectangular Acrylic Board
UBG-500F Breakaway Goal

215 lbs.

HRKIT-AC

\$1,499 each

Aluminum Fan Board



Hoop Rejuvenator™ H-Frame Kit
36" x 54" Aluminum Fan Board
UBG-500F Breakaway Goal

119 lbs.

HRKIT-FA

\$1,249 each

Steel Board

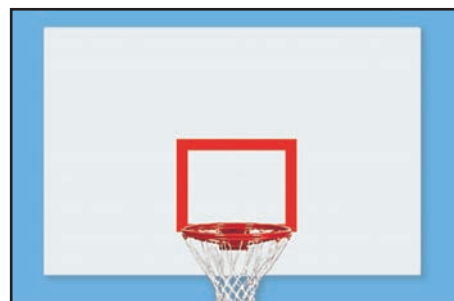

Hoop Rejuvenator™ H-Frame Kit
42" x 72" Rectangular Steel Board
UBG-500F Breakaway Goal

206 lbs.

HRKIT-RC

\$1,549 each

Hoop Rejuvenator™ Direct Mount Kit
42" x 72" Rectangular Acrylic Board
UBG-500F Breakaway Goal

190 lbs.

HRKIT-AC-DIR

\$1,299 each

Hoop Rejuvenator™ Direct Mount Kit
36" x 54" Aluminum Fan Board
UBG-500F Breakaway Goal

101 lbs.

HRKIT-FA-DIR

\$1,049 each

Hoop Rejuvenator™ Direct Mount Kit
42" x 72" Rectangular Steel Board
UBG-500F Breakaway Goal

185 lbs.

HRKIT-RC-DIR

\$1,299 each



Ultimate Adjustable Gooseneck with The Hoop Rejuvenator™

Always Regulation Height, Never out of Plumb

A complete system that offers the benefits of the Hoop Rejuvenator™ with a rugged heavy-wall, 4-1/2" O.D. galvanized steel upright. The H-frame style has a 4 foot extension. Comes standard with the Ultimate Playground Breakaway Goal (UBG-500F) found on page 83. Visit our web site at www.jaypro.com for more information and details.



Ultimate Adjustable Gooseneck
with 42" x 72" Rectangular Acrylic Board
UBG-500F Breakaway Goal

JAG-AC 370 lbs.

\$2,249 each



Ultimate Adjustable Gooseneck
with 36" x 54" Aluminum Fan Board
UBG-500F Breakaway Goal

JAG-FA 274 lbs.

\$1,969 each

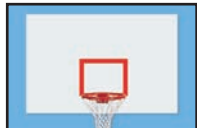

Ultimate Adjustable Gooseneck
with 42" x 72" Rectangular Steel Board
UBG-500F Breakaway Goal

JAG-RC 361 lbs.

\$2,249 each

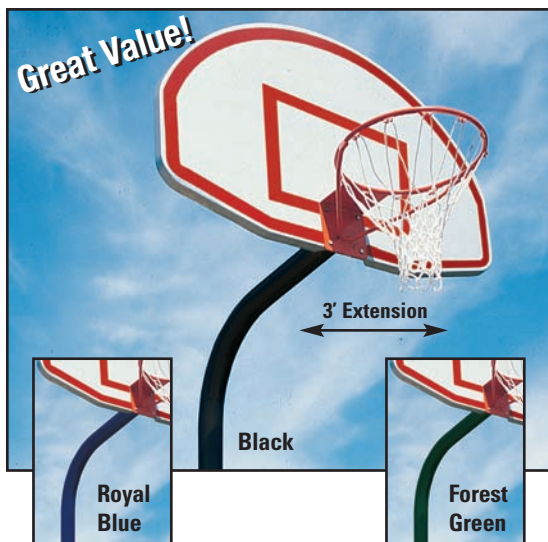

3-1/2" Round Post 3' Extension, Direct Mount

Rugged 3-1/2" O.D. zinc undercoated steel upright with 3' extension. Uprights are powder coated in your choice of black, royal blue or forest green. **Fan-Shaped Aluminum Backboard** - 36" x 54" powder coated white with border and target. **Single Rim Goal** - Heavy duty goal and nylon net included. Backboard and goal are directly mounted for exceptional strength.

455-FABT-SR-BK 3' Ext. - Black 144 lbs. **\$995 each**

455-FABT-SR-RB 3' Ext. - Royal Blue 144 lbs. **\$995 each**

455-FABT-SR-FG 3' Ext. - Forest Green 144 lbs. **\$995 each**



POST AVAILABLE IN COLORS!



Black



Royal Blue



Forest Green



Basketball Pole Padding

30" wide pad is designed to wrap around a 4-1/2" O.D. post. Foam filler is 4" thick high density polyurethane and 14oz vinyl cover has grommet flaps for rear lacing. Cord included. Pad is 6' high. See right for color selections.

PPP-5HP 9 lbs. **\$259 each**



Pro-Style Round Protector Pads

Professional style pads for 4-1/2" O.D. post. Foam filler is 6" thick cylindrical high density polyurethane foam with rear cut-out for easy attachment. 14 oz. nylon reinforced vinyl cover completely encloses the foam filler. Vinyl cover has full length hook-and-loop closure flap. Pad is 6' high. See right for color selections.

PPP-500HP 16 lbs. **\$379 each**



Colors shown may not be an exact match.

Pro-Style Round Protector Pads

Same as the PPP-500HP except made for 5-9/16" O.D. post. See right for color selections.

PPP-700HP

20 lbs. **\$449 each**



Outdoor Bent Pole Units - Round Posts

4-1/2" diameter post with 4' offset
-OR-
5-9/16" diameter post with 6' offset



As simple as 1, 2, 3!

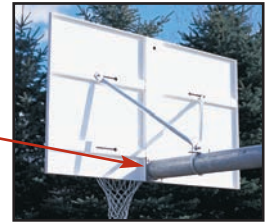

Backboard and Goal direct mount to welded plate on gooseneck for durability and stability.

Powder Coated Post Available - Please Call for Pricing or Details.

Step 1:

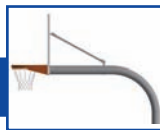

Choose Pole

Step 2:



Choose Board

Step 3:



Choose Goal

4-1/2" Diameter Gooseneck Post 4' Offset	Super Goal GBSG-50	Double Rim GDR-54	Playground Goal UBG-500	Breakaway Playground UBG-500F
Fan Aluminum ALB-24BT	996-FABT-SG 277 lbs. \$1,195	996-FABT-DR 279 lbs. \$1,199	996-FABT-UG 288 lbs. \$1,279	996-FABT-UB 290 lbs. \$1,349
Solid Steel 850-RB-BB	996-RS-SG 361 lbs. \$1,395	996-RS-DR 363 lbs. \$1,399	996-RS-UG 372 lbs. \$1,464	996-RS-UB 374 lbs. \$1,534
Perforated Steel SR-PERF	996-PERF-SG 391 lbs. \$1,550	996-PERF-DR 393 lbs. \$1,555	996-PERF-UG 402 lbs. \$1,615	996-PERF-UB 404 lbs. \$1,685
Perforated Aluminum AL-PERF	996-ALP-SG 341 lbs. \$1,550	996-ALP-DR 343 lbs. \$1,555	996-ALP-UG 352 lbs. \$1,615	996-ALP-UB 354 lbs. \$1,685
Acrylic ACRB-72	996-AC-SG 366 lbs. \$1,529	996-AC-DR 369 lbs. \$1,534	996-AC-UG 377 lbs. \$1,549	996-AC-UB 379 lbs. \$1,669

5-9/16" Diameter Gooseneck Post 6' Offset	Super Goal GBSG-50	Double Rim GDR-54	Playground Goal UBG-500	Breakaway Playground UBG-500F
Fan Aluminum ALB-24BT	656-FABT-SG 357 lbs. \$1,780	656-FABT-DR 359 lbs. \$1,785	656-FABT-UG 368 lbs. \$1,856	656-FABT-UB 370 lbs. \$1,926
Solid Steel 850-RB-BB	656-RS-SG 441 lbs. \$2,090	656-RS-DR 443 lbs. \$2,095	656-RS-UG 452 lbs. \$2,075	656-RS-UB 454 lbs. \$2,145
Perforated Steel SR-PERF	656-PERF-SG 471 lbs. \$2,190	656-PERF-DR 473 lbs. \$2,195	656-PERF-UG 482 lbs. \$2,260	656-PERF-UB 484 lbs. \$2,330
Perforated Aluminum AL-PERF	656-ALP-SG 421 lbs. \$2,190	656-ALP-DR 423 lbs. \$2,195	656-ALP-UG 432 lbs. \$2,260	656-ALP-UB 434 lbs. \$2,330
Acrylic ACRB-72	656-AC-SG 446 lbs. \$2,174	656-AC-DR 448 lbs. \$2,179	656-AC-UG 457 lbs. \$2,244	656-AC-UB 459 lbs. \$2,244

NEW VOLLEYBALL SOCCER FOOTBALL LACROSSE BASEBALL FIELD MARKING SCOREBOARD BASKETBALL GYMNASIUM FIELD SEATING BALL STORAGE PHYS. ED. TENNIS



Outdoor Straight Pole Adjustable Units



Backboard and goal direct mount to welded plate. Support struts for additional support.



Double units available, call for details.



Step 1:

Choose Pole



Step 2:

Choose Board



Step 3:

Choose Goal



4-1/2" Diameter Straight Post 4' Offset	Super Goal GBSG-50	Double Rim GDR-54	Playground Goal UBG-500	Breakaway Playground UBG-500F
Fan Aluminum ALB-24BT	SPA4-FABT-SG 322 lbs. \$1,167	SPA4-FABT-DR 324 lbs. \$1,172	SPA4-FABT-UG 333 lbs. \$1,237	SPA4-FABT-UB 335 lbs. \$1,307
Solid Steel 850-RB-BB	SPA4-RS-SG 406 lbs. \$1,467	SPA4-RS-DR 408 lbs. \$1,472	SPA4-RS-UG 417 lbs. \$1,537	SPA4-RS-UB 419 lbs. \$1,607
Perforated Steel SR-PERF	SPA4-PERF-SG 436 lbs. \$1,451	SPA4-PERF-DR 438 lbs. \$1,456	SPA4-PERF-UG 447 lbs. \$1,521	SPA4-PERF-UB 449 lbs. \$1,591
Perforated Aluminum AL-PERF	SPA4-ALP-SG 386 lbs. \$1,451	SPA4-ALP-DR 388 lbs. \$1,456	SPA4-ALP-UG 397 lbs. \$1,521	SPA4-ALP-UB 399 lbs. \$1,591
Acrylic ACRB-72	SPA4-AC-SG 411 lbs. \$1,467	SPA4-AC-DR 413 lbs. \$1,472	SPA4-AC-UG 422 lbs. \$1,537	SPA4-AC-UB 424 lbs. \$1,607

5-9/16" Diameter Straight Post 6' Offset	Super Goal GBSG-50	Double Rim GDR-54	Playground Goal UBG-500	Breakaway Playground UBG-500F
Fan Aluminum ALB-24BT	SPA6-FABT-SG 402 lbs. \$1,680	SPA6-FABT-DR 404 lbs. \$1,685	SPA6-FABT-UG 413 lbs. \$1,756	SPA6-FABT-UB 415 lbs. \$1,826
Solid Steel 850-RB-BB	SPA6-RS-SG 451 lbs. \$1,990	SPA6-RS-DR 453 lbs. \$1,995	SPA6-RS-UG 462 lbs. \$1,975	SPA6-RS-UB 464 lbs. \$2,045
Perforated Steel SR-PERF	SPA6-PERF-SG 481 lbs. \$2,090	SPA6-PERF-DR 483 lbs. \$2,095	SPA6-PERF-UG 492 lbs. \$2,160	SPA6-PERF-UB 494 lbs. \$2,230
Perforated Aluminum AL-PERF	SPA6-ALP-SG 431 lbs. \$2,090	SPA6-ALP-DR 433 lbs. \$2,095	SPA6-ALP-UG 442 lbs. \$2,160	SPA6-ALP-UB 444 lbs. \$2,230
Acrylic ACRB-72	SPA6-AC-SG 456 lbs. \$2,074	SPA6-AC-DR 458 lbs. \$2,079	SPA6-AC-UG 467 lbs. \$2,144	SPA6-AC-UB 469 lbs. \$2,144

NEW VOLLEYBALL SOCCER FOOTBALL LACROSSE BASEBALL FIELD MARKING SCOREBOARD BASKETBALL GYMNASIUM FIELD SEATING BALL STORAGE PHYS. ED. TENNIS

Glass Backboards

A Jaypro® Replacement Package: Backboard, Goal and Edge Padding!



THE "UNBREAKABLE" PACKAGE

Combine
All Three
And Save!

Replacement Package

Combine our 42" x 72" Unbreakable Rectangular Glass Backboard (GBRUB-42), Collegiate "Revolution" Goal (GBA-642) and Bolt-On Edge Padding (MBBP-6) and save! *Please specify backboard edge padding color when ordering, see page 81 for color selections.*



BBRP-42

230 lbs.

\$1,195 each



Limited Lifetime Warranty!

42" Unbreakable Rectangular Glass Backboard

Unique design allows the impact load on goal to be transferred directly to an engineered lower reinforced steel frame member, without putting any stress on the glass. High strength, clear anodized aluminum channel outer frame, which is lightweight and attractive. 42" x 72" by 1/2" thick rectangular tempered glass. Direct mount or four corner mounting applications: 4" x 5" hole pattern, or 35-1/2" x 62/66" mounting dimensions. Pre-drilled for "Safe-Pro" bolt on edge padding. Meets all NCAA and NGHS specifications.

GBRUB-42

190 lbs.

\$899 each



Same as GBRUB-42 except backboard is 42" x 54".

GBRUB-54

150 lbs.

\$695 each



48" Rectangular Glass Backboard

Similar features except backboard is 48" x 72". Hole pattern is 5" x 5", or 42" x 63/66" mounting dimensions.

GBAFR-48

200 lbs.

\$995 each



GBRUB-42 Shown with optional goal and edge padding. See pages 81-83 for details.



42" Rectangular Glass Conversion Backboard

Converts a fan shaped backboard to a rectangular shaped backboard. Eliminates the need to alter either the playing court or backstop system. 42" x 72" by 1/2" thick rectangular tempered glass. 4" x 5" hole pattern, 20" x 35" mounting dimensions. High strength, clear anodized aluminum frame. Meets all NCAA and NFHS specifications.

GCBB-35

230 lbs.

\$1,095 each



Note: The glass itself is not unbreakable. Breakage in transit, during mounting, malicious act or deliberate attempts to damage are not covered under warranty. Boards used with height adjusters below 10' are not covered under warranty.



GCBB-35 Shown with optional goal and edge padding. See pages 81-83 for details.



LED Backboard Light Kit

Connects with most shot clocks allowing backboard to light up when shot clock or game time reaches zero and when final segment counts down to zero. One each consists of 5 bright LED strips, fits 42" x 72" backboards. Requires 9VDC-17VDC (formal specified voltage is 10.5VDC). Most kits include, but not limited to: light strips, Y-cable, alignment guides, 10'L lower supply DC cable and installation manual. Hook up and wiring varies by shot clock manufacturer and should be done by a qualified installer. Please specify the Manufacturer and model of existing unit. Does not ship from Jaypro's CT warehouse. Call for freight quote.

BB-LED42

25 lbs.

Call for Pricing

When selecting a replacement for an existing backboard, it is important to identify some key factors that can create problems with the installation. There are two major differences in how a board may be attached to the backstop unit, either direct mount or corner mount. Direct mount is identified by a centrally located fitting or fixture attached to the board directly behind the rim; while corner mount features independent attachments at each corner of the board. The correct identification of the type of mounting structure is critical in selecting the correct replacement board. Digital photos of your equipment would be beneficial, and could help us help you in evaluating a replacement. We will be happy to work with you to insure that your replacement board installs without incident. If replacing a fan shaped board, order a glass conversion board (GCBB-35).



TrueBounce® Backboards

Patented Perforated Polycarbonate Backboard

We can retro-fit to most indoor/outdoor support structures! Perforated holes release the ball's energy creating a "true bounce" off the backboard. 1/2" polycarbonate board is shatterproof, 250x stronger and 30% lighter than conventional glass backboards. Sound and wind resistant construction, graffiti, UVF and scratch resistant coating. Comes in three sizes, see below. Custom trim available in 10 stock colors. Manufactured in the USA. Does not ship from Jaypro's CT warehouse. Call for freight quote.

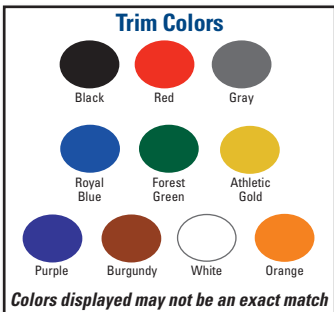

36" x 54" Backboard

3654CB 75 lbs. **\$1,425 each**

42" x 72" Backboard

4272CB 130 lbs. **\$2,045 each**

48" x 72" Backboard

4872CB 150 lbs. **\$2,045 each**

Steel Backboards



Rectangular Perforated Steel Backboard

Rugged 42" x 72" 11 gauge steel face has 1/4" diameter perforations to provide an open area to minimize wind resistance. Rear support frame allows for multiple mounting conversions. Durable white powder coated finish with a silk-screened orange target and border. 5" x 5" goal mounting pattern.

SR-PERF 170 lbs. **\$749 each**



Rectangular Steel Backboard

Rugged 42" x 72" 12 gauge steel. Rear welded 20" x 35" mounting pattern. Durable white powder coated finish. 5" x 5" goal mounting pattern.

850RB-BB 200 lbs. **\$829 each**

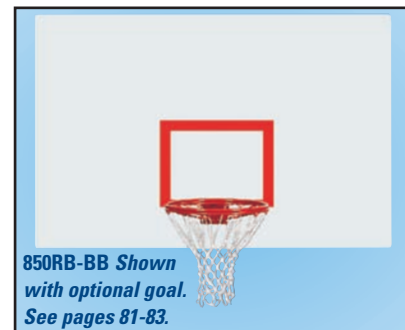

Aluminum Backboards

Rectangular Perforated Aluminum Backboard

42" x 72" aluminum face has 1/4" diameter perforations to provide an open area to minimize wind resistance. Rear support frame allows for multiple mounting conversions. Durable white powder coated finish with a silk-screened orange target and border. 5" x 5" goal mounting pattern.

AL-PERF 120 lbs. **\$799 each**

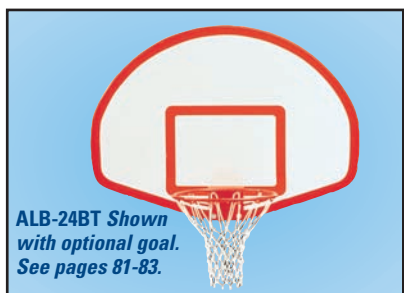

Fan Aluminum Backboard with Border and Target

36" x 54" cast aluminum with 1-1/2" flange. Painted white with orange target and border markings. 5" x 5" goal mounting pattern. **Lifetime Guarantee!**

ALB-24BT 56 lbs. **\$529 each**



close up of hole pattern

NEW VOLLEYBALL SOCCER FOOTBALL LACROSSE BASEBALL FIELD MARKING SCOREBOARD BASKETBALL GYMNASIUM FIELD SEATING BALL STORAGE PHYS. ED. TENNIS

Acrylic Backboards

**42" Rectangular Acrylic Backboard**

42" x 72" rectangular acrylic backboard. Includes border and target. 5" x 5" goal mounting pattern.

ACRB-72M 145 lbs. **\$849 each** 

36" Rectangular Acrylic Backboard

36" x 48" rectangular acrylic backboard. Includes border and target. 4" x 5" goal mounting pattern.

LS-44AB 75lbs. **\$649 each** 

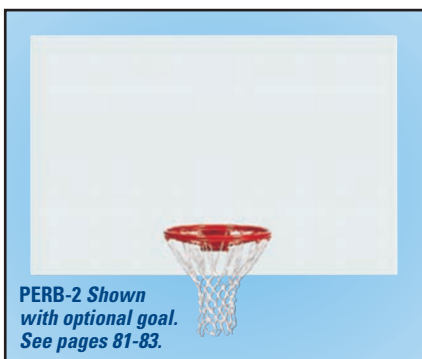

Polyethylene Backboards

**42" Rectangular Polyethylene Backboard**

42" x 72" rectangular polyethylene construction. 5" x 5" hole pattern, direct mount. 8 counter sunk mounting holes.

PERB-2 112 lbs. **\$679 each** 

Fan Shaped Poly Backboard

Official size 39" x 54" x 1" thick HD polyethylene. 5" x 5" goal mount pattern.

FGBB-1 62 lbs. **\$449 each** 

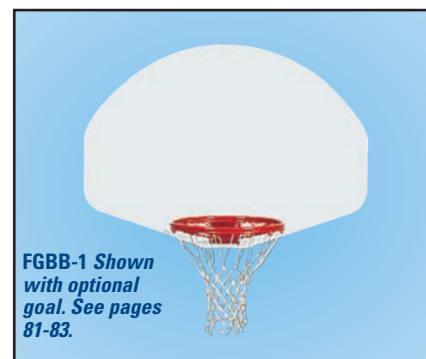

These indestructible backboards are great for playgrounds with all levels of play!

Fiberglass and Wood Backboards Available!

Call Customer Service or Visit www.jaypro.com for Information and Details.

**Possession Indicator**

Red LED display in a durable plastic case. Toggle switch operation, includes top red indicator lights and an AC adapter with a 15' long cord.

POSIND1 3 lbs. **\$139 each**

**Basketball Court Stencil**

Quickly, easily and accurately allows you to paint a regulation basketball court on any driveway, patio or play area in the yard. No measuring or guesswork! Simply unroll the precision-cut stencils, tape down, and you are ready to go. A free paint roller is included. Just roll the paint over the stencil holes, when you are finished painting, pull up the stencil and your court is ready for play. Finished court size is approx. 13' x 21'.

BCS-1 5 lbs. **\$42 each**

Table Top Scoreboard

Economical rugged table top design offers built-in rear control panel with visual display. Digits are lit by LED lights in amber and gold. Scores up to 199 and timer goes up/down to 99:59. Buzzer sounds automatically at end of period or manually. Uses 110v with 15' power cord. Size: 15"H x 24"W x 10"D.

TTS10 12 lbs. **\$679 each**

**Digital display control panel on back for operator.**

BEST ON THE MARKET!



Safe-Pro™ Edge Padding

“Safe-Pro” Bolt-On Edge Padding

The MBBP-6 bolts easily to all 72” official glass backboards and is available in 16 vibrant colors. Meets all NCAA, NFHS and FIBA specifications. Available colors shown on right (from top to bottom) Our **NEW COLOR: TEAM PINK** along with our existing colors Cardinal, Burnt Orange, Purple, Old Gold, Royal Blue, Scarlet, Navy Blue, Yellow, Forest Green, Orange, Maroon, Kelly Green, Black, Columbia Blue, Gray and Light Purple. **10 Year Replacement Warranty.**

- | | |
|--------------------------------|---------------------------------|
| MBBP-6PK – Pink | MBBP-6FG – Forest Green |
| MBBP-6C – Cardinal | MBBP-6OR – Orange |
| MBBP-6TO – Burnt Orange | MBBP-6M – Maroon |
| MBBP-6P – Purple | MBBP-6KG – Kelly Green |
| MBBP-6OG – Old Gold | MBBP-6BK – Black |
| MBBP-6RB – Royal Blue | MBBP-6CB – Columbia Blue |
| MBBP-6S – Scarlet | MBBP-6GY – Gray |
| MBBP-6NB – Navy Blue | MBBP-6LP – Light Purple |
| MBBP-6YW – Yellow | |

10 10 Year Replacement Warranty



MBBP-6 22 lbs. **\$189 each**



The form fit pad with pin style attachment eliminates sagging of the pad underneath the rim.

Bolt-On Edge Padding Includes 2 Steel Connectors For Perfect Pad Alignment!

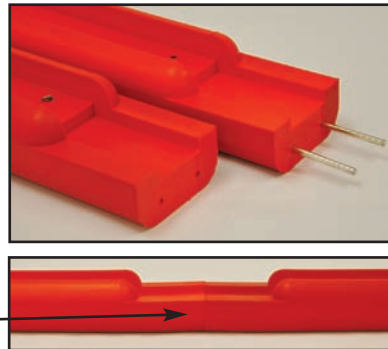

“Safe-Pro” 54 Bolt-On Edge Padding

Same as above except available in a 54” size. Available colors are scarlet, Gray, black and royal blue. **10 year warranty.**

54” - Scarlet MBBP-54S	54” - Gray MBBP-54GY	54” - Black MBBP-54BK	54” - Royal Blue MBBP-54RB	16 lbs.	\$179 each
---	---------------------------------------	--	---	---------	-------------------

Bolt-On Edge Padding

1.5” Bolt-On Edge Padding for Wood or Acrylic Backboards

Molded tough “L” shape urethane material. Fits any 48”W Acrylic board. Indoor or outdoor use.

Molded tough “L” shape urethane material. Fits any 72”W Acrylic or Wood board. Indoor or outdoor use.

Molded tough “U” shape urethane material. Fits any 72”W Wood board. Indoor or outdoor use.

EP-48 48” - Black \$159 each	EP-46 72” - Black \$179 each	MBBP-WB 72” - Gray 16 lbs. \$269 each
--	--	---

Glue-On Edge Padding

Glue-On Edge Padding

Made of self-skinning urethane foam and a tough molded urethane skin to provide the exterior with a uniform colored appearance. Meets all NCAA and NFHS specifications. Available in gray. Fits 1-1/2” or 2” thick backboard. **One Year Warranty.**

1-1/2” Edge Padding

GBB-15 5 lbs. **\$179 each**

2” Edge Padding

GBB-2 6 lbs. **\$179 each**

NEW VOLLEYBALL SOCCER FOOTBALL LACROSSE BASEBALL FIELD MARKING SCOREBOARD BASKETBALL GYMNASIUM FIELD SEATING BALL STORAGE PHYS. ED. TENNIS

The "Revolution" and "Shot" Series of Breakaway Goals from Jaypro!

Collegiate "Revolution" and "Shot" Goals

These high performance case hardened designs are not only the most durable goals on the market, but they also adjust for all levels of play. These NCAA, NFHS and FIBA compliant goals adjust from **140 lbs. to 250 lbs.** even after **50,000 revolutions**, while maintaining all of it's rebound features. Your choice of **"Revolution" Hideaway** or **"Shot" Pigtail** net attachment and size. Includes mounting hardware and anti-whip net. Please check existing hole patterns for correct replacements!

7 Year Limited Warranty

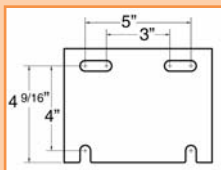
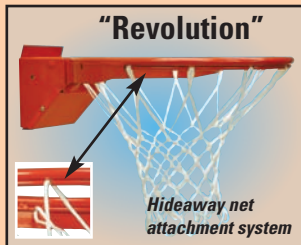

GBA-642 Mounting Plate
GBA-542 Mounting Plate

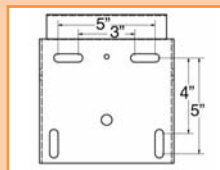

GBA-648 Mounting Plate
GBA-548 Mounting Plate

Collegiate "Revolution" Goals

GBA-642 Hideaway for 42" board 26 lbs. **\$279 each**

GBA-648 Hideaway for 48" board 26 lbs. **\$279 each**

Collegiate "Shot" Goals

GBA-542 Pigtail for 42" board 26 lbs. **\$265 each**

GBA-548 Pigtail for 48" board 26 lbs. **\$265 each**

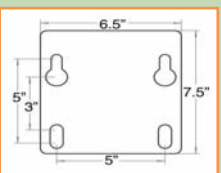

GBA-180 Mounting Plate

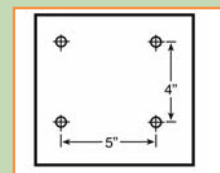

GBA-18042 Mounting Plate

Competitor 180° Breakaway Goals

Fully adjustable, positive lock releasing goal is made to break from any angle. Meets all NCAA, FIBA and NFHS rules. Hideaway net attachment. Includes nylon net and zinc plated mounting hardware for 42" or 48" glass board.

GBA-18042 42" board 39 lbs. **\$420 each**

GBA-180 48" board 39 lbs. **\$430 each**



Competitor Scholastic Breakaway Goal - Adjustable

This extremely durable breakaway goal can be adjusted to withstand different levels of pressure. Fits 5" x 4" hole patterns for all models of glass 42" backboards. Positive lock holds solid playing position. Includes durable powder coated finish and pigtail ring. Meets NCAA and NFHS specifications. Includes mounting hardware and heavy duty nylon net.

GBA-342A 26 lbs.

\$179 each



Best Seller!

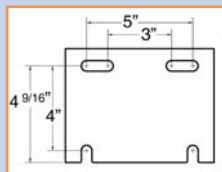

GBA-342A Mounting Plate
GBA-600 Mounting Plate

Competitor Pro Breakaway Goal - Adjustable

This goal has the same durable features as GBA-342A (above) plus pro level hideaway net attachment system. Includes mounting hardware and heavy-duty nylon net.

GBA-600 26 lbs.

\$189 each



Shooter's Ring

Attaches to all standard basketball goals to create a smaller diameter rim for shooting practice. The all metal ring design requires no tools for quick and easy installation.

SHOTRING

4 lbs.

\$24 each



Rebound Ring

Designed to develop rebounding skills and keeps the ball from falling through the rim. Attaches to any 18" goal with 3 screws.

RBRING

3 lbs.

\$24 each

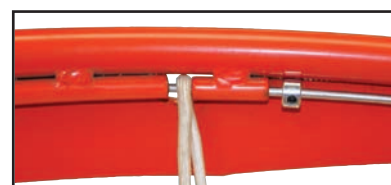

Hideaway Rim Steel Replacement Ring

Can be used with any rim with hideaway net attachment. Simply slide through brackets to attach net.

BBSR-R

1 lb.

\$13 each



Fixed Goals - Single Rims

Economy Single Rim Front Mount

Official powder coated orange. Includes nylon net and zinc plated mounting hardware.

G-35

12 lbs.

\$52 each

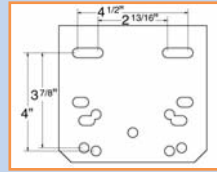

G-35 Mounting Plate



Single Rim Goal

Official size 18" ring of 5/8" steel; 7/16" round steel brace. Official powder coated orange. Includes nylon net and zinc plated mounting hardware. Universal hole pattern.

GB-55

13 lbs.

\$72 each

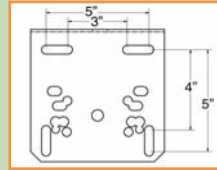

GB-55 Mounting Plate



Super Goal

Official size, 5/8" high-tensile alloy rim is 1-1/2 times the strength of normal rim material. 5/8" support arms provide superior support. Durable, baked powder coated finish. Includes nylon net and zinc plated mounting hardware. Universal hole pattern.

GBSG-50

16 lbs.

\$89 each

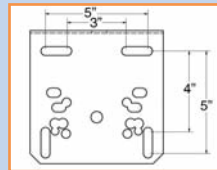

GBSG-50 Mounting Plate



Fixed Goals - Double Rims

Double Rim Goal

Super durable, official size 18" double ring of 5/8" and 1/2" welded together for added strength and rigidity. Official powder coated orange. Includes nylon net and zinc plated mounting hardware. Universal hole pattern.

GDR-54

18 lbs.

\$105 each

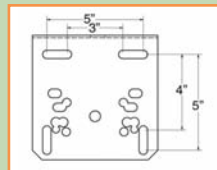

GDR-54 Mounting Plate



Ultimate Playground Goal

The strongest outdoor fixed rim available! Double, solid rim design with universal hole mounting pattern. No-fail net lock system. Powder coated finish. Includes premium nylon net. Can be used with chain net.

UBG-500

27 lbs.

\$149 each

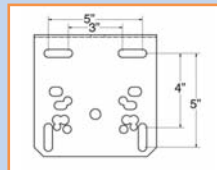

*UBG-500 Mounting Plate
UBG-500F Mounting Plate*



Ultimate Playground Breakaway Goal

Can be used indoor and outdoors. Includes nylon net. Can use with chain net. Official Universal hole pattern.

UBG-500F

29 lbs.

\$199 each



Nylon Net - 12 loop design, 680/32 braided white

JNY-4HP

1 lb.

\$5 each

"Anti-Whip" Nylon - 12 loop, 120 threaded, heavy-duty braided cord stops from flipping onto rim

JNY-6HP

1 lb.

\$14 each

Standard Chain Net, heavy-duty "S" hooks - fits any style goal

J-3

2 lbs.

\$29 each

Removable Goal Bracket Kit

Stop theft, potential damage and unwanted play with this removable goal bracket. Perfect for park and recreation courts! Long lasting stainless steel bracket will fit most front mount backboards with a 5" x 5" goal mounting pattern. Not to be used with breakaway goals. Best if used with GB-55, GBSG-50 or GDR-54. Kit includes bracket, hardware and padlock.



GAK-5

5 lbs.

\$59 each

Renovating or building a new facility? Jaypro offers a full range of products and the engineering experience to help with design and installation.

Direct Drive Winch
Page 88

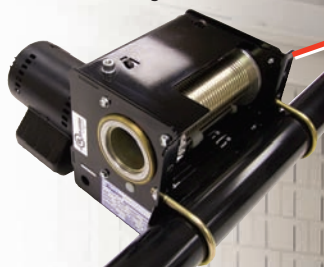

Safety Strap
Page 88



Shot Clock Mounting Bracket
Call for Details



Basketball Backstops
Call for Details

Height Adjuster
Page 89



Backboard Edge Padding
Page 81

Replacement Package
Page 78

From the small Gymnasium to the large Multi Use Facility, Jaypro has over 60 years of Expertise to Design and Facilitate your Project!

Online files are available at www.jayprospecs.com to help the Architects and Designers with their projects. EasySpec is another tool available to help configure valid building products in real time. Download CSI Specifications, Product Cut Sheets, REVIT Files, CAD Drawings, Load Charts, Installation Instructions and more!

Facility Gym Equipment available thru select authorized Jaypro Sports Construction Dealers!



Gym Divider Curtains

Looking for a way to divide your sports facility? Jaypro offers a variety of divider curtains that are both functional and attractive. Choose from the power controlled Fold Up, Top Roll or Slope Fold options or the manual Walk Draw option. Available in solid vinyl or vinyl coated mesh with several color options. Custom made to your facilities size requirements.

Best Seller!

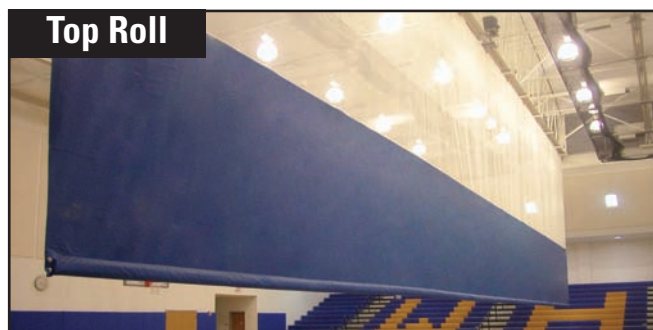
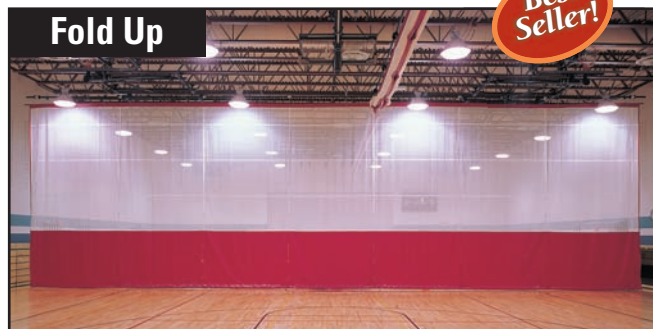
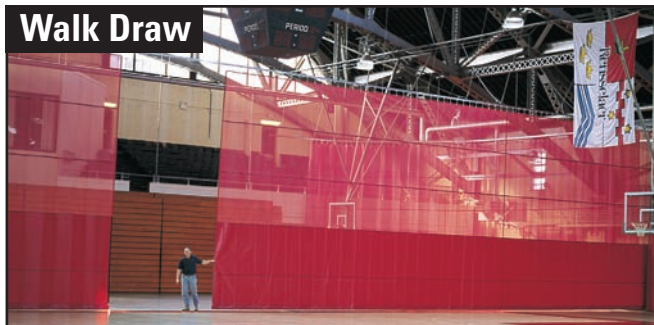

Mini Top Roll Curtain

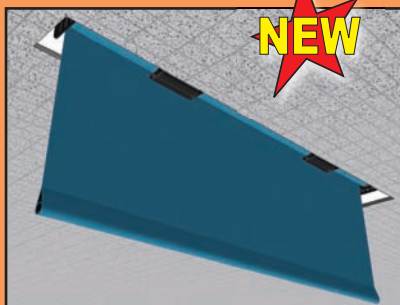

- ✓ Use in many different locations
- ✓ Not just for gymnasiums anymore
- ✓ Separate meeting rooms
- ✓ Close off areas
- ✓ Print School graphics or advertising on curtain
- ✓ Electrically controlled
- ✓ Developed for and used at Barclays Arena in Brooklyn, NY

The NEW versatile Mini Top Roll Curtain can be used anywhere in small spaces in Schools or Facilities to provide separation or blackout. Disappears up into or behind the ceiling structure and rolls down at the touch of a button. Constructed of 14 oz. or 18 oz. reinforced vinyl and 9 oz. vinyl coated polyester mesh. Designed to be compact and tight fitting to the ceiling structure. Driven by an internal tubular motor requiring 120 volt power.

TC-710 Call Customer Service for pricing and details

MH-D-A

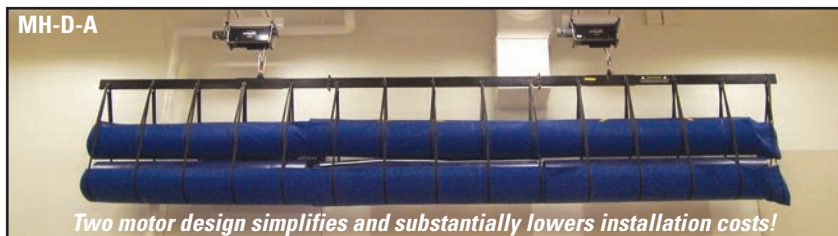

Matlok™ Wrestling Mat Storage System Safety Strap

Pioneer of the first ever safe strap for Mat Storage Systems! Fully patented, tested and validated by an international testing laboratory and have an unmatched **1 Year Warranty.**



ML-2000 84 lbs.

\$1,295 each

Securelift™ Wrestling Mat Storage System

Eliminate the risk of injury to students, athletes, and coaches from manually lifting and transporting heavy, awkward mats. Gain valuable storage space and extend the life of your wrestling mats! Simply roll the mat(s) onto the sling, attach the sling to the load bar, turn the key to raise the unit and store at ceiling height. **See specs for steel/structural requirements.** Available in Single, Double and Mini sizes, call for pricing or visit www.jaypro.com for details.

NEW VOLLEYBALL SOCCER FOOTBALL LACROSSE BASEBALL FIELD MARKING SCOREBOARD BASKETBALL GYMNASIUM FIELD SEATING BALL STORAGE PHYS. ED. TENNIS

Wall Mounted Backstops

Telescoping frame allows for precise positioning of the backboard off the wall.

System comes complete and ready for installation - no cutting of pipes is necessary for units over 4' face of bank. (some drilling is required). Attractive silver semi-gloss powder coated finish on all frame pipes and steel fittings.

2"x 8" Southern Yellow Pine mounting wood boards are ready for use: drilled and counter-bored, edges rounded & surfaces sanded with lacquer finished front, back and all edges. (Optional vertical wood stringers available, call for info).

1/4" Zinc-plated steel chain, 3/8" Quick links and turnbuckles

Heavy duty welded steel fittings provided with four (4) 1/2" diameter mounting bolts each (compare with competitor's 2)



Heavy duty stamped steel fittings mount board directly to frame. **Jaypro Exclusive Design!**

Heavy Walled 1.90" & 1.66" O.D. Frame Pipes. Smaller O.D. pipe telescopes into larger O.D. pipe for up to 48" of adjustability at time of install



Heavy duty stamped steel fittings with four (4) 1/2" attachment bolts and grade 5 steel hinge bolts. **Jaypro Exclusive Design!**

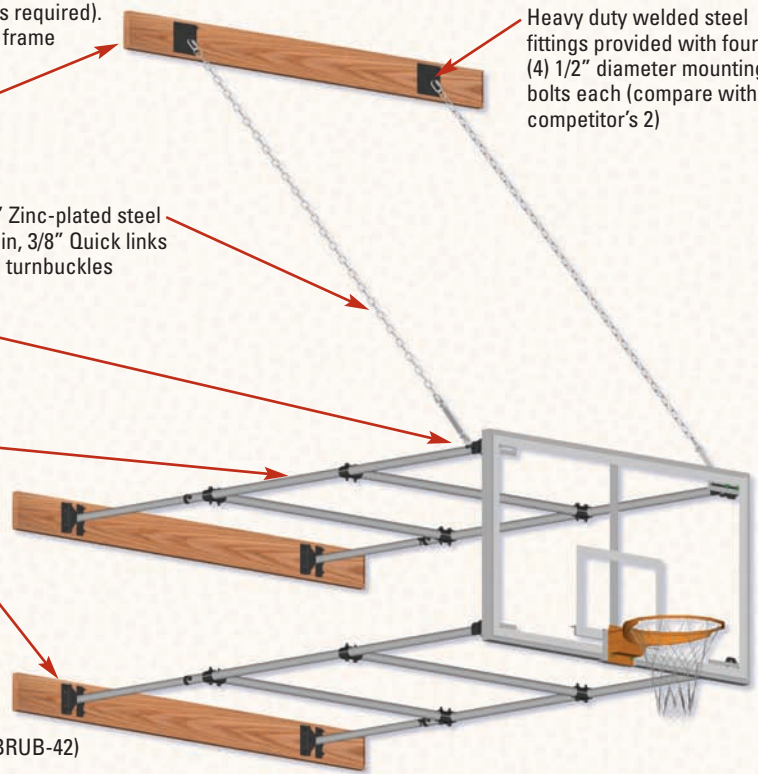

Includes:

- Choice of Unbreakable 42" Rectangular Glass Backboard (GBRUB-42) or Aluminum Fan Board with Border and Target (ALB-24BT)
- Breakaway Rim (GBA-642 for Glass Board) or (GBA-542 for Fan Board)

Options:

- Optional color edge padding available (not shown). See page 81.
- Optional Height Adjuster (see page 89 for details).

Wall Anchors not included (order separately depending on your wall construction)

STATIONARY BACKSTOP SYSTEM

Economical non-folding wall mounted backstop

Wall to Face of Backboard	42" Glass Board	Price	Aluminum Fan Board	Price
2'- 4' Extension	ST24GB	\$1,695	ST24FA	\$1,595
4'- 6' Extension	ST46GB	\$1,895	ST46FA	\$1,795
6'- 8' Extension	ST68GB	\$1,995	ST68FA	\$1,895
8'- 10' Extension	ST810GB	\$2,295	ST810FA	\$2,195
10'- 12' Extension	ST1012GB	\$2,349	ST1012FA	\$2,249

HEIGHT ADJUSTERS FOR WALL MOUNTS

Order with Stationary, Fold-Up or Side-Fold Backstops

Ordering Instructions - To order your wall-mounted backstop with a height adjuster, simply add the part number of the height adjuster style desired as a suffix to the system model number. (Example: ST68GB-EHAPW, Stationary backstop with an electric height adjuster with power wand control). See page 89 for Height Adjuster details.

Manual Height Adjuster

AHA 180 lbs. **\$1,343 kit**

Electric Height Adjuster with Key Switch

EHAKS 195 lbs. **\$2,576 kit**

Electric Height Adjuster with Power Wand Control
(order power wand separately)

EHAPW 200 lbs. **\$2,674 kit**

SR5187  HM2711

"Double" Dual Expansion Machine Bolt Wall Anchor For solid concrete walls, including Pre-Cast Concrete or Filled Block.

- HM2711** **\$4 each**
- SR5187** 1/2" Threaded Rod - 12" long **\$4 each**
- SR5276** 1/2" Threaded Rod - 18" long **\$4.50 each**

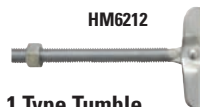

No. 1 Type Tumble Toggle Wall Anchor

For hollow walls, Non-Filled CMU (when anchoring into hollow block wall).

HM6212 **\$6 each**



"Safe-Pro" Bolt-On Edge Padding
See page 81 for details.

16 lbs. **\$189 each**



FOLD UP BACKSTOP SYSTEM

Backboard folds up against the wall for storage. Backstop is raised or lowered by manual (TW-700M) or electric winch (TW-2000-1), both sold separately. Adequate ceiling height is required to accommodate backstop in the folded up position. Jaypro recommends the use of safe straps (PL-1000) on all units, see page 88. To add height adjusters, see page 89.



Wall to Face of Backboard	42" Glass Board	Price	Aluminum Fan Board	Price
4'- 6' Extension	FU46GB	\$2,349	FU46FA	\$2,249
6'- 8' Extension	FU68GB	\$2,395	FU68FA	\$2,295
8'- 10' Extension	FU810GB	\$2,695	FU810FA	\$2,595
10'- 12' Extension	FU1012GB	\$2,749	FU1012FA	\$2,649



Fold up (side view)

Electric Winch with Wall Mounting Kit

Includes TW-2000 electric winch (see page 88 for winch details) plus finished wood mounting boards and hardware.

TW-2000KT1

\$1,395 each

Manual Winch with Wall Mounting Kit

Includes TW-700M manual winch (see page 88 for winch details) plus finished wood mounting boards and hardware. Manual winch handle sold separately.

TW-700MKT1

\$775 each



(Shown with optional height adjuster and Posilok safety strap).

Safety Strap with Wall Mounting Kit

Includes PL-1000 Safety Strap (see page 88 for details) plus finished wood mounting boards and hardware.

PL-1000KT1

\$625 each

SIDE FOLD BACKSTOP SYSTEM

Backboard folds to the side, against the wall for storage. May be built to fold in either direction. Spring loaded locking pin holds backstop in both playing and stored position. Adequate ceiling height and wall clearance is required to accommodate backstop in the side folded position. To add height adjusters, see page 89.

Wall to Face of Backboard	42" Glass Board	Price	Aluminum Fan Board	Price
4'- 6' Extension	SF46GB	\$1,949	SF46FA	\$1,849
6'- 8' Extension	SF68GB	\$1,995	SF68FA	\$1,895
8'- 10' Extension	SF810GB	\$2,195	SF810FA	\$2,095
10'- 12' Extension	SF1012GB	\$2,249	SF1012FA	\$2,149

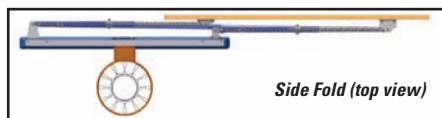

Side Fold (top view)



IMPORTANT NOTES FOR WALL MOUNTED BACKSTOPS:

1. Wall mounted basketball systems should only be installed on walls capable of supporting the weight of the backstop plus the additional weight of a player hanging off the rim. If you are unsure if your wall is capable of handling such loads consult an architect, structural engineer or contractor.
2. Wall mounted basketball systems require a minimum ceiling height and unobstructed wall height, depending on distance from the wall. Please refer to the backstop dimensional drawings and charts on www.Jaypro.com or call.
3. Jaypro Sports bears no responsibility for the structural integrity of the walls these backstops are mounted to.
4. Installation should only be done by a qualified installer using suitable wall anchors. Please contact Jaypro Sports for assistance in locating a qualified installer.
5. Jaypro Sports recommends two types of wall anchors depending on whether the anchoring is done into solid concrete or hollow block. When anchoring to Un-Filled CMU walls, often both anchors are required. Order wall anchors separately.
6. Jaypro Sports recommends that all basketball backstops be inspected on an annual basis to ensure all wall anchors are sound, fasteners are secured and cables are not worn. Please contact Jaypro Sports for assistance in locating a qualified installer.

NEW VOLLEYBALL SOCCER FOOTBALL LACROSSE BASEBALL FIELD MARKING SCOREBOARD BASKETBALL GYMNASIUM FIELD SEATING BALL STORAGE PHYS. ED. TENNIS

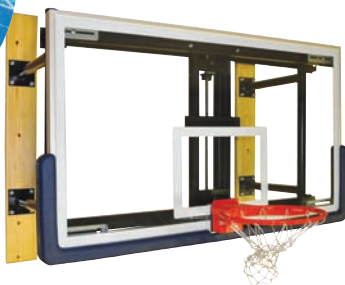

Wall Mount Shooting Station

Great for young kids learning shooting skills and the art of free throws. Adjusts quickly and easily from 8' to 10'. **3' Face of Bank**. Comes complete with our full size non breakable rectangular glass backboard (GBRUB-42) and our Revolution Breakaway rim with hideaway net attachment for added safety (GBA-642). Wood backing included. An included adjustment handle will move the board up and down to your desired height, anywhere from 8' to 10'. Match your school colors with an optional "Safe-Pro" edge pad (MBBP-6XX on page 81). See page 86 for mounting hardware.

WMWH	Package with height adjuster	440 lbs.	\$2,795 each
WMSS	Package without height adjuster	285 lbs.	\$1,995 each



Adjustable Wall Mount Shooting Station

Height adjustable from 7.5' to 10'. Acrylic backboard with aluminum backboard frame available in two sizes - 36" x 48" x 1/2" or 36" x 60" x 1/2". Extension from wall to backboard ranges from 33" - 44" depending on height. Heavy duty flex goal with nylon net and black edge padding (not shown) included. Indoor and outdoor use. See page 86 for mounting hardware.

WM-48	48" Board	\$1,169 each
WM-60	60" Board	\$1,289 each



Hand crank for height adjustment

Basketball Backstop Winches



Optional electric key switch utilizing a single key to both raise and lower a backstop.



**Direct Drive Oil & Maintenance Free
No Belts or Chains 1-Year Warranty!**

Direct Drive Backstop Winch

Designed to raise and lower basketball backstop units. Features a 1 HP, instantly reversing, 115 volt, single phase torque motor that delivers at least **800 pounds of line pull** at a speed of 11 ft/minute, a unidirectional worm brake and self locking worm drive, optional 3 position key switch and universal mounting bracket to fit 3-1/2" O.D. pipe. Maintenance free operation. Remote receivers and control systems available separately. See page 87 for wall installation.

TW-2000-1	72 lbs.	\$1,149	+ any required hardware & cable. Call for info.
KS-13	2 lbs.	\$79	Key Switch

Manual Winch

This state-of-the-art manual winch is compact and easy to use. Composite gears are self lubricating and eliminate the need for oil. Unique worm brake and grooved drum helps prevent backdrive and cable from kinking. Cable retention roller prevents unspooling of cable. Not for use on back-stops with ceiling height over 27'.

1-Year Warranty!

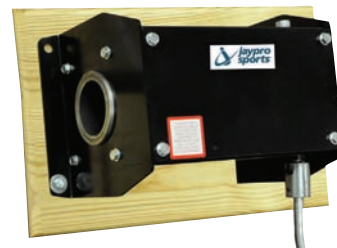

TW-700M	24 lbs.	\$725 each
TW-700MKT1	Includes Wall Mounting Kit	\$775 each
TW700H	Handle	\$299 each



5-Year Warranty!

SecureLift™ Backstop Winch

Designed to raise and lower basketball backstop units. Features a 1 HP, instantly reversing motor that delivers **1250 pounds of line pull** at a speed of 11 ft/minute and newly designed limit switch. Large grooved cable drum ensures long cable life and proper coiling. Positive locking in worm gear provides a strong hold under load. Maintenance free operation. Standard key switch operation with remote receivers and control systems available separately.

JP-3500	70 lbs.	\$1,349 each
----------------	---------	---------------------



SAFETY FEATURE:
The ED-902 includes unique anti-torque safety attachment that prevents "kick-back" during operation providing an extra measure of safety.

Manual Winch Operator

Heavy duty portable winch operator is designed for use with the TW-700M manual winch to raise and lower all types of backstops. Comes with attractive carry/storage case.

ED-902	19 lbs.	\$775 each
---------------	---------	-------------------



Posilok™ Backstop Safety Strap

Designed to automatically lock a backstop in position should a malfunction occur during raising or lowering the unit. Features a belt capable of withstanding 7300 pound loads, visible maximum safe extension patch and Telltale Indicator that notifies when the safety strap has been called into action. Other features include a self-checking, fail safe locking mechanism, automatic reset, stronger clamping system and versatile mounting. **1 Year Warranty**

PL-1000	17 lbs.	\$559 each
----------------	---------	-------------------



**Patented Design...
exclusively from Jaypro!**

HEIGHT ADJUSTERS:

Aluminum Height Adjuster - Adjust the height of your backboard and rim from 10' to 8'. Lightweight and easy to operate. Constructed of extruded aluminum interlocking channels, which provides tighter clearances resulting in less shake than other height adjusters on the market - even at the lower playing heights. Choose either manual operation or electric control. The electric height adjuster is driven by a 1/6 HP motor, requiring 120 volt power. Electric height adjusters may be hard wired, or temporarily powered off a standard 120 volt electrical wall outlet.

HEIGHT ADJUSTER STYLES:

Manual Height Adjuster (AHA) - Easily raises and lowers the backboard with a manual hand crank **HA-1H** (provided). The manual height adjuster may also be controlled using a portable Cordless Drill operator **CD-80H** purchased separately (see below).

Electric Height Adjuster with Key Switch Control (EHAKS)- Requires running a dedicated 120 volt, 15 amp circuit to the wall mounted key switch and motor. Three position, momentary operated key switch provided.

Electric Height Adjuster with Power Wand Control (EHAPW)- Control your electric height adjuster without the added expense of hard wiring. Does not require an electrician or permanent electrical wiring. Height adjuster comes with a built-in power wand receptacle. To operate, simply plug Power Wand into receptacle and any 120 volt, 15/20 amp wall outlet. (**HAPW-100** Power Wand purchased separately).

OPERATORS:

Power Wand Controller - Easy to use, portable hand held controller, plugs into standard 120 volt, 15/20 amp electrical wall outlet. Operates by moving the momentary toggle switch to desired position.

Manual Hand Crank - Replacement hand crank for manual height adjuster (6' long).

HAPW-100 10 lbs. **\$349 each**

HA-1H 5 lbs. **\$69 each**



Cordless Manual Height Adjuster Operator

Heavy duty 18 volt Cordless Drill for operating the AHA-XX manual backstop height adjuster. Comes with charger, two batteries and an attractive carry/storage case.

CD-80H 18 lbs. **\$695 each**



Ceiling Suspended Single Drop Series with Electric Motor

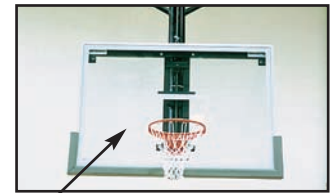

The narrow profile of the AHA height adjuster maintains a visually "clean" target area.

Height Adjuster Kits for Existing Backstops

Take the guess work out of how to add a height adjuster to your existing backstop. Kits fit most common backstop frames. **Kits include: height adjuster** (choose manual or electric), **42" rectangular glass backboard** (GBRUB-42), **breakaway rim** (GBA-642), and **all mounting hardware** to attach to your center strut (6" OD to 6-5/8" OD) or double drop (H-frame) backstops. To order, choose your style of backstop and desired height adjuster (see description above). Double drop kits have mounting holes that are drilled in the field so they can fit most any frame width. See page 81 for edge padding info. Please call for assistance if you have any other configuration that is not listed below.

CENTER STRUT FRAMES

Manual Height Adjuster

GBCS-AHA 330 lbs. **\$1,800 kit**

Electric Height Adjuster with Key Switch

GBCS-EHAKS 345 lbs. **\$3,121 kit**

Electric Height Adjuster with Power Wand Control

GBCS-EHAPW 350 lbs. **\$3,219 kit**

DOUBLE DROP FRAMES

Manual Height Adjuster

GBDD-AHA 400 lbs. **\$1,981 kit**

Electric Height Adjuster with Key Switch

GBDD-EHAKS 415 lbs. **\$3,214 kit**

Electric Height Adjuster with Power Wand Control

GBDD-EHAPW 420 lbs. **\$3,312 kit**

Center Strut Frame



Double Drop Frame

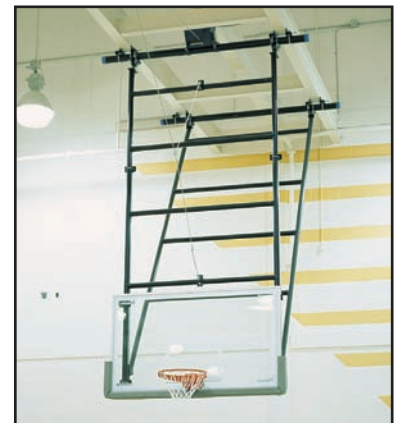

NEW VOLLEYBALL SOCCER FOOTBALL LACROSSE BASEBALL FIELD MARKING SCOREBOARD BASKETBALL GYMNASIUM FIELD SEATING BALL STORAGE PHYS. ED. TENNIS

The "ELITE" Series of Adjustable Portable Backstops

Choose the portable that best fits your needs with our 8', 5'6" and 4'6" extension models.

**Shot Clock Mounting Bracket
for Portable Backstop**
Shot Clock not included.

PBEL-SCBEA 30 lbs. **\$349 each**



**Optional Graphics
Available!**

**Call Customer Service
for Details and Pricing.**



jaypro
**ELITE
9600**

96" Play Safe Area

**Backstop & Backboard
Edge Padding Included**

**Adjustable in 6" increments from
8' to 10' from the floor.
Spring assisted one person set up!**

PBEL96

Jaypro Elite 9600

Our BEST Competition Goal! Features 96" extension, 42" x 72" unbreakable glass backboard, direct mount 180° break away rim and bolt on backboard padding. Six 8" diameter non-marking, non-skid wheels for easy transport, double rear wheels to help widen the load. Stabilizing front foot pads independently adjustable for leveling the unit. Rear anchor kit included to meet NCAA and NFHS Rules for Competition Portable Goals. Instock padding of royal blue or red, other colors available. Optional graphics on padding, please call customer service for details. Ballast weight of 1000 lbs. included.

PBEL96

2600 lbs.

\$9,095 each

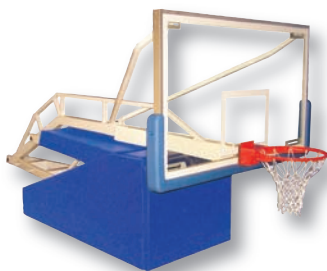

***Folds down to compact storage position.
Designed to fit through standard double
size doorways (height-wise).
Fits through door width of 76"***

**Call or visit www.jaypro.com
for complete specifications.**

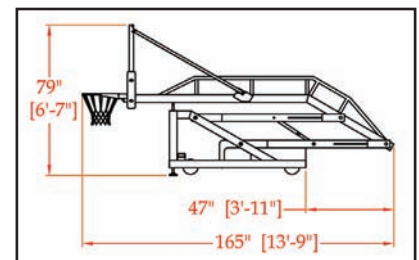

PBEL96 folded dimensions

Flatbed tow truck, forklift or loading dock required to unload all units.

The "ELITE" Series of Adjustable Portable Backstops

Choose the portable that best fits your needs with our 8', 5'6" and 4'6" extension models.



66" Play Safe Area

Backstop & Backboard
Edge Padding Included

Optional
Graphics
Available!

Adjustable in 6" increments from
8' to 10' from the floor.
Spring assisted one person set up!

Jaypro Elite 6600

Features 66" extension, 42" x 72" unbreakable glass backboard (GBRUB-42) with a **Limited Lifetime Warranty**, a direct mount Collegiate "Revolution" goal (GBA-642) with a **7 Year Limited Warranty** and bolt on backboard padding. 8" diameter non-marking, non-skid wheels for easy transport. Stabilizing front foot pads independently adjustable for leveling the unit. Instock padding of royal blue or red, other colors available. Optional graphics on padding, please call customer service for details. Ballast weight of 800 lbs. included. **Optional rear anchor kit available below.**

PBEL66

2400 lbs.

\$7,995 each

Rear Anchor Kit - See page 92 for details.

PBELKIT-100 Floating wood floors 3 lbs.

\$199 each

PBELKIT-89 All other floor types 3 lbs.

\$199 each

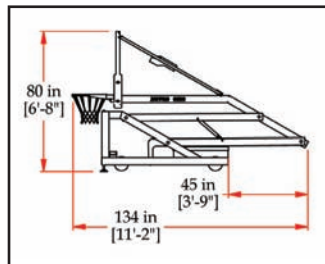

PBEL66 folded dimensions

*Folds down to compact storage position.
Designed to fit through standard double
size doorways (height-wise).
Fits through door width of 76"*

Call or visit www.jaypro.com
for complete specifications.

Flatbed tow truck, forklift or loading dock required to unload all units.

The "ELITE" Series of Adjustable Portable Backstops



ELITE 5400



54" Play Safe Area

Backstop & Backboard Edge Padding Included

Optional Graphics Available!

Spring Assisted, One Person Setup!

Jaypro Elite 5400

This versatile sidecourt unit features a 54" extension, 42" x 54" unbreakable glass backboard (GBRUB-42) with a **Limited Lifetime Warranty**, a direct mount Collegiate "Revolution" goal (GBA-642) with a **7 Year Limited Warranty** and bolt on backboard padding. 8" diameter non-marking, non-skid wheels for easy transport. Stabilizing front foot pads independently adjustable for leveling the unit. Instock padding of royal blue or red, other colors available. Optional graphics on padding, please call customer service for details. Ballast weight of 800 lbs. included. **Optional rear anchor kit available below.** (Also available with a larger 42" x 72" unbreakable glass backboard. Includes 1000 lbs. of ballast weight.)

PBEL54	42" x 54" Board	1600 lbs.	\$6,495 each	
PBEL5472	42" x 72" Board	1850 lbs.	\$7,195 each	

Adjustable in 6" increments from 8" to 10' from the floor. Fits through door width of 58" for the PBEL54 and 76" for the PBEL5472.

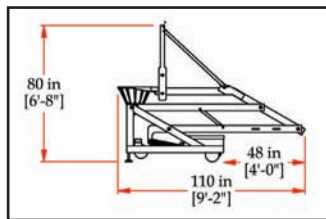

PBEL54 folded dimensions

Rear Anchor Kit

Includes threaded floor anchor and all hardware necessary to attach to built in rear eye bolt.

PBELKIT-100	Floating wood floors	3 lbs.	\$199 each
PBELKIT-89	All other floor types	3 lbs.	\$199 each

Adjustable Portable Recreational Backstop



Supplied to the 2014 Kevin Ollie Basketball Camp held at the University of Connecticut



48" Play Safe Area

Backstop Padding Included

No tools are required for the fully-collapsible unit to pass through a 48" doorway without disassembly.

PBB-200

Portable Basketball Unit

A top-notch portable system designed to meet the demands of adult recreation with the flexibility to meet all the needs of elementary level activities. Acrylic backboard is 32" x 48" x 3/8". Easily adjusts for smooth height setting from 6'6" to 10' no tools required! Direct mount Collegiate "Revolution" goal (GBA-642) with a **7 Year Limited Warranty!** Backboard extension is 48" at 10' high. Some assembly is required. Rust-resistant powder coated finish. Customer supplied ballast required is 300 to 350 pounds. Front mast padding color choices are available on page 75.

PBB-200	500 lbs.	\$2,895 each	
Optional Backboard Edge Padding - Black Only			
EP-48	16 lbs.	\$159 each	
Replacement Backboard - 32" x 48"			
AB-4832	75 lbs.	\$425 each	



Fold down for easy storage!

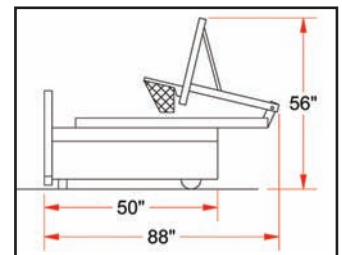

PBB-200 folded dimensions

WARNING! Failure to install customer supplied ballast according to instructions provided could result in serious injury.



NEW VOLLEYBALL SOCCER FOOTBALL LACROSSE BASEBALL FIELD MARKING SCOREBOARD BASKETBALL GYMNASIUM FIELD SEATING BALL STORAGE PHYS. ED. TENNIS

Jaypro is proud to offer Wall Pads for your Facility!



Standard Wall Pads

Padding provides excellent wall protection to absorb shock impact and reduce noise levels in any facility. Vinyl covered panels are made of 2" thick foam with OSB exterior grade wood backing. Mounting options include 1" nailing margin or Z clip channel (shown below). Mounting hardware not included. Does not ship from Jaypro's CT warehouse. Call for freight quote.

Standard Class A Flame Retardant Pad

Similar to standard wall pads except include a 2" highly flame resistant polymerized open cell foam. Does not ship from Jaypro's CT warehouse. Call for freight quote.

Standard Wall Pads

Description	Size	Description	Weight	Price
JWC-J006	2' x 6'	Standard Wall Pad w/1" lip	26 lbs.	\$125
JWC-J006Z	2' x 6'	Standard Wall Pad w/Z-clip	26 lbs.	\$145
JWC-J005	2' x 5'	Standard Wall Pad w/1" lip	22 lbs.	\$115
JWC-J005Z	2' x 5'	Standard Wall Pad w/Z-clip	22 lbs.	\$155

Standard Class A Flame Retardant Pad

Description	Size	Description	Weight	Price
JWCA-J006	2' x 6'	Class A Wall Pad w/1" lip	33 lbs.	\$209
JWCA-J006Z	2' x 6'	Class A Wall Pad w/Z-clip	36 lbs.	\$219
JWCA-J005	2' x 5'	Class A Wall Pad w/1" lip	28 lbs.	\$199
JWCA-J005Z	2' x 5'	Class A Wall Pad w/Z-clip	30 lbs.	\$209

Wall padding is available in standard 2' x 5' or 2' x 6' panels. Custom sizes, lettering, graphics and eco-friendly wall pads also available. Please call for details and pricing.

Installation Techniques

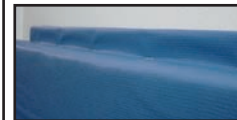

1" Nail Margins



Z-Clip Mounting

Wall Padding Colors Choices: Color may not be an exact match

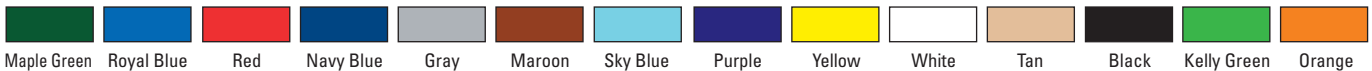

Column and Corner Pads, I-Beam Wraps and Stage Padding are all Available, Please Call for Details and Pricing.

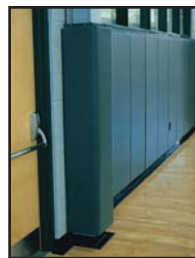

Column Pads



Corner Pads



I-Beam Wrap



Stage Padding



DUAL PURPOSE WALL / TUMBLING MAT

4' x 6' non-folding mat serves as wall padding or as a tumbling mat. Vinyl covered 2" thick foam pad features 4 carrying handles and 1-1/2" W hook-and-loop closures on all four sides. Please specify color when ordering.

GMVH-1

\$345 each



HOOK & LOOP CLOSURE WALL HANGING STRIP

For use with our GMVH-1 wall mat. The 2" wide aluminum strip is easily mounted to any gymnasium wall. Pressure-sensitive 1-1/2" W hook-and-loop closure securely bonds to the aluminum strip for long lasting use. Sold in 4' sections only.

VMH-13

1 lb.

\$26 each



NEW VOLLEYBALL SOCCER FOOTBALL LACROSSE BASEBALL FIELD MARKING SCOREBOARD BASKETBALL GYMNASIUM FIELD SEATING BALL STORAGE PHYS. ED. TENNIS



Protect your gym during nonathletic events with ultra durable 3-ply fabric. Flame retardant, antibacterial, antifungal and rot/mildew resistant. Constructed in 10'W sections for easy handling. Meets California Fire Marshall Spec. Floor covering: specify dimensions needed. We suggest adding 6"-12" for overlapping each section. 5' wide minimum charge. Does not ship from Jaypro's CT warehouse. Call for freight quote.

Gym Guard Color Selections

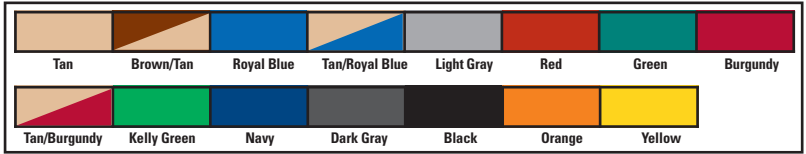

18 oz. available in solid colors only. Colors shown may not be an exact match.

18 oz. Fabric
GGFPS-16 5 Year Warranty **\$0.85 sq. ft.**

22 oz. Fabric
GGFPS-22 7 Year Warranty **\$0.99 sq. ft.**

27 oz. Fabric
GGFPS-24 8 Year Warranty **\$1.20 sq. ft.**

Safety Storage Racks

All steel construction with 8" diameter non-marking wheels that lock and swivel. Includes two hand cranks. Does not ship from Jaypro's CT warehouse. Call for freight quote.

- MSR-6** 6 Roll Rack **\$2,999 each**
- MSR-8** 8 Roll Rack **\$3,449 each**
- MSR-10** 10 Roll Rack **\$3,649 each**

Gym Guard Floor Protection Accessories Available!

Tape, Dispenser, Power Winder, Brush Assembly and more Racks. Call Customer Service or visit www.jaypro.com for Info and Details.

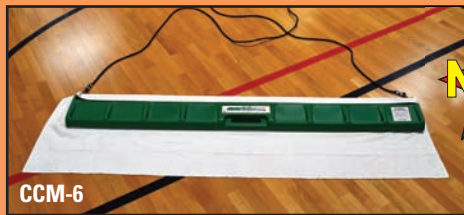

CCM-6



KCP-1

NEW

Item	Description	Price
CCM-6	6' Courtclean Mop	\$499 each
CCT-6	6' Courtclean Towel	\$42 each
KCP-1	Keyclean Pro Set	\$289 each
KCPD-2	Keyclean Pro Pads	\$63 each
CCSS-1	1 Gallon Super Shine-All	\$49 each

Courtclean

Have a clean and safe floor in minutes with this damp mop system! **Courtclean:** 6' mop made of rotationally molded linear density polyethylene material. Comes with a convenient built-in carrying handle, hook and loop fasteners that keep the towel in place and a sturdy metal pull strap fastener. (Includes mop and towel). Replacement towels purchased separately. **Keyclean Pro:** Two large 18"x24" mops made with highly absorbent microfiber pads, attaches to a 6' adjustable two-piece aluminum handle. (Includes 2 mops and 2 pads). Replacement pads purchased separately. Fast drying, slip resistant to reduce injuries and reduces refinishing frequency. Does not ship from Jaypro's CT warehouse. Call for freight quote.

Scorers Tables with Shatterproof Graphic Face Panels

Illuminated scorers tables with school spirit that comfortably seats up to 3-4 people. Two styles to choose from: Free Standing or Bleacher Mount in either 8ft. or 10 ft. lengths. All tables are 120VAC, 60 Hz. Includes lockable swivel casters with 3" poly wheels. Counter top includes multiple cup holders and also folds vertically for storage. Large access holes for console and laptop cords or other electronics. Under the counter storage bins hold extension cords, power adapters and other accessories. Removeable face panels for multiple sponsors or team logos. Graphics included - artwork provided by customers. Comes in 8 colors: Black, Navy Blue, Royal Blue, Purple, Dark Green, Maroon, Red or Green. Please call Customer Service for more details and information. Refer to page 80 for Possession Indicator. Does not ship from Jaypro's CT warehouse. Call for freight quote.



ST-8BM



ST-10FS

FREE STANDING

ST-8FS 8 ft. long 357 lbs. **\$3,199 each**

ST-10FS 10 ft. long 454 lbs. **\$3,399 each**

BLEACHER MOUNT

ST-8BM 8 ft. long 397 lbs. **\$3,649 each**

ST-10BM 10 ft. long 637 lbs. **\$3,869 each**

Player Seating Available!



For the sideline, locker room even VIP guests. Quality steel framed seating with vinyl covered cushions. 24 piece minimum order required. **Player seating is custom. To receive a quote, please submit an electronic copy of your logo, logo placement, lettering, colors required and quantity. Lead time on custom seating orders is approximately 4-6 weeks from sample approval after order placement.**



Note: Due to differences in wall construction, Jaypro does not provide anchors or mounting hardware to attach the wall stringers to gym walls. Consult your architect or contractor to determine the best and safest installation methods for your facility.

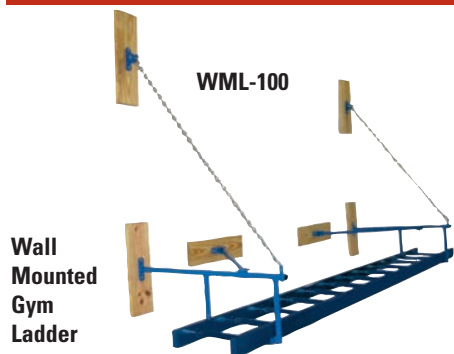

Wall Mounted Gym Ladder

Textured Surface for Safety!

Develop physical fitness, strength and coordination! Powder coated "rough" blue finish over steel, and the supports are welded for strength and durability. The inner braces provide stability for lateral movement. The ladder is attached with wood stringers (included) and is further supported with a heavy duty chain. Frame extends 48" from wall. Ladder is 18"W x 12"L.

WML-100 187 lbs. **\$1,595 each**

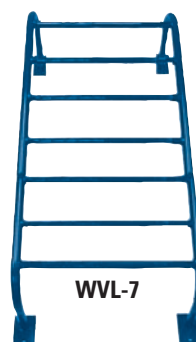

WVL-7

Vertical Climbing Ladder

Features 1-5/16" O.D. steel tubing construction with rough blue powder coated finish. Heavy duty wall mounting plates. Size is 22"W x 60"L.

WVL-7 77 lbs. **\$339 each**



WGC-20

Wall Grid Climber

Features 1-5/16" O.D. steel tubing construction with rough, blue powder coated finish. Grid is 4 x 5 rows with 6" pattern. Heavy duty wall mounting plates. Size is 30"W x 45"L.

WGC-20 72 lbs. **\$465 each**



EWM-30

Adjustable Wall-Mounted Chinning Bar

Perfect for elementary through university level use. Provides 2' of height adjustment in 6" increments. All-welded 30"W steel frame work has a **powder coated finish**. Oak backmounts for illustrative purposes only.

EWM-30 28 lbs. **\$249 each**

Jump Rope Rack

Keep your jump ropes untangled and ready for use. Wall mounted all steel construction. Features five 10" long pegs for storage. **Powder coated finish**. 27" long.



PE-110

PE-110 5 lbs. **\$45 each**



OBR-16

Portable Bicycle Rack

All-welded frame constructed of 1-5/8" galvanized steel with gray powder coated finish. Available in 2 sizes designed to hold bicycles or mopeds.

Item	Capacity	Size	Weight	Price
OBR-16	16	102"L x 30"W x 30"H	67 lbs.	\$595
OBR-10	10	67"L x 30"W x 30"H	60 lbs.	\$495
OBR-8	8	55"L x 30"W x 30"H	56 lbs.	\$469
OBR-6	6	47"L x 30"W x 30"H	49 lbs.	\$449

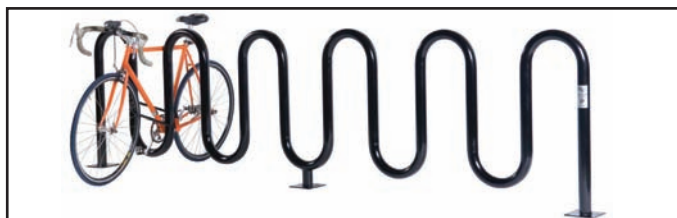

Wave Bicycle Rack

A contemporary bike rack available in ground or surface mount styles. Constructed with 2-3/8" O.D. schedule 40 tubing. 36" H with 12" spacing between waves. Powder coated finish available in colors shown to right. Standard powder coated color is black. **1 year warranty**. Please specify color when ordering. Does not ship from Jaypro's CT warehouse. Call for freight quote.

Wave Bicycle Rack - Below Grade Mount - Galvanized

Item	Capacity	Length	Weight	Galvanized
HDWBR-7	7	64"	74 lbs.	\$535
HDWBR-9	9	87"	96 lbs.	\$735



Below Grade Mount - Powder Coated

Item	Powder Coated
HDWBR-7PC	\$535
HDWBR-9PC	\$735

Wave Bicycle Rack - Surface Mount - Galvanized

Item	Capacity	Length	Weight	Galvanized
HDWBR-7SM	7	64"	74 lbs.	\$555
HDWBR-9SM	9	87"	96 lbs.	\$755

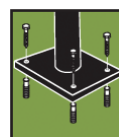

Surface Mount - Powder Coated

Item	Powder Coated
HDWBR-7SMPC	\$555
HDWBR-9SMPC	\$755

Color Choices for Wave Rack Colors shown may not be an exact match.



NEW VOLLEYBALL SOCCER FOOTBALL LACROSSE BASEBALL FIELD MARKING SCOREBOARD BASKETBALL GYMNASIUM FIELD SEATING BALL STORAGE PHYS. ED. TENNIS



Are you in the process of constructing a new field or facility? Jaypro can help. We offer products for several sports that you can “package” together to outfit your field.

Renovating or building a new field is a huge undertaking. Jaypro can assist you through the process from start to finish. We offer specifiable products in several sports that will meet, if not exceed your programs needs. Time management is important so let us start by helping you with product selection. Let us help you package your field construction projects to save time and \$\$\$ for your facility!



Lacrosse/Multi-Sport Ball Stop System

15' x 65' FieldPro Multi-Sport Ball Stop System

Stop wasting time during practices and games chasing missed shots or errant passes and ensure the safety of athletes, coaches and spectators on adjacent fields. 15'H x 65'L backstop is designed ideally to fit behind lacrosse and field hockey goals. Includes four 4" O. D. heavy wall aluminum uprights with black powder coated finish, ground sleeves, corrosion resistant hardware and 1-3/4" square mesh #36 knotless nylon black net with 1/4" rope border. Net can easily be raised and lowered with a rope and pulley system.

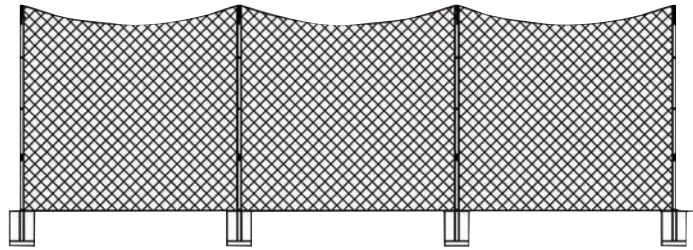

FNMB-65

15'H x 65'W

\$2,295 each

Football Ball Stop System



FieldPro Football Ball Stop System

Backstops are installed behind football goal posts to keep field goals and extra point kicks inside the field. 40'W net can easily and quickly be raised and lowered during games or practice with a rope and marine style swivel pulley system with integrated ball bearings. Includes heavy duty 6-5/8" diameter aluminum poles, ground sleeves, corrosion resistant hardware and 3-1/2" square mesh #36 knotless nylon black net with 1/4" rope border. Available in 30' or 40' heights. Poles can be powder coated black, call Customer Service for details.

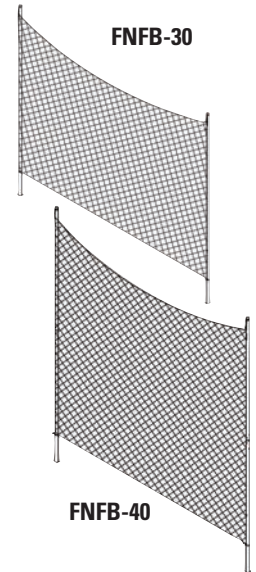

FNFB-30

FNFB-40

FNFB-30 30'H x 40'W 530 lbs. **\$4,195 each**

FNFB-40 40'H x 40'W 762 lbs. **\$6,595 each**

Soccer Ball Stop System

20' x 65' FieldPro Soccer Ball Stop System

Stop wasting time during practices and games chasing missed shots or errant passes and ensure the safety of athletes, coaches and spectators on adjacent fields. 20'H x 65'L backstop is designed specifically to fit behind soccer goals. Includes four 4" O.D. heavy wall aluminum uprights with black powder coated finish, ground sleeves, corrosion resistant hardware and 3-1/2" square mesh #36 knotless nylon black net with 1/4" rope border. Net can easily be raised and lowered with a rope and pulley system.



FNSB-65

250 lbs.

\$2,095 each

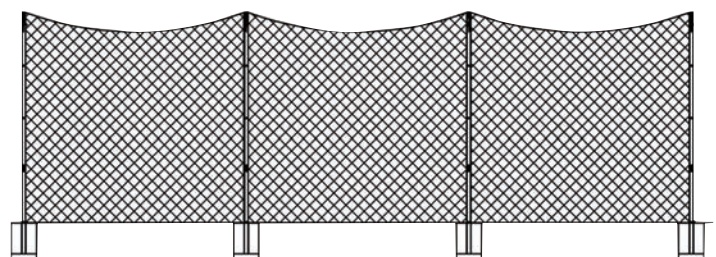

FieldPro Netting™

Safety, Goal Backstop or Perimeter Netting Systems for all Turf fields

In today's congested sports complexes with multi-use fields in close proximity to each other, keeping balls within the confines of the field is important. Stop wasting time during practices and games chasing missed shots or errant passes. Ensure the safety of athletes, coaches and spectators alike on adjacent fields and tracks. Jaypro's FieldPro Netting Systems offer ultimate design flexibility to suit your backstop and perimeter netting needs.

Offered in six different heights and pole styles.

- The **10 ft. Straight Pole System**, with multi-sport net, is ideal for use as a Lacrosse or Field Hockey backstop net. The net is clipped at the top and bottom of each pole for easy removal.
- The **15 ft., 20 ft. and 30 ft. Straight Pole Systems** come with an easy to use hoisting system, which allows quick and easy lowering or removal of the net after the game, the season, or before a big storm. Reinstalling the net is a snap - all from ground level, no need for a ladder.
- The **20 ft. Offset Pole System** provides 3 ft. of offset, which is ideal for use around the perimeter of soccer and baseball/softball fields. Plus, an added measure of safety from ricocheting balls.
- The **12 ft. Portable System** is ideal where in-ground netting systems are not appropriate. Used to divide any field or space to keep separation of sports or activities, indoors or outdoors. Poles are easily transported on a tip and roll base. Includes corrosion resistant hardware, cable clamps and sliding rings for easy net assembly.
- All in-ground systems come with **Ground Sleeves and Caps**, to allow for complete system removal.
- **Basic Features and Recommendations:** Maximum pole spacing is 20 ft. We recommend netting system to be set back at least 25 ft. from the playing field. Features include hoisting system (excluding 10 ft. and 12 ft. poles) and stainless hardware. Ground sleeves with caps come standard with all In-Ground systems. Tip and roll bases with 5 gallon jugs (filled in the field) and 10" diameter tires come standard with the Portable system.

In-Ground Systems



10 ft. Straight Pole with Optional Powder Coating



20 ft. Straight Pole



20 ft. Offset Pole

Portable System



No Flat Tires!!

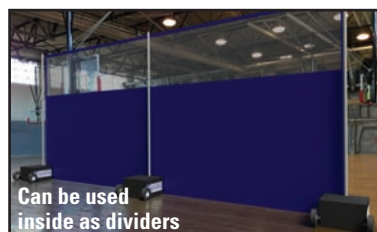

Can be used inside as dividers



Tip & roll base for easy transport



Four jugs weigh down each base

ALL SURFACE FRIENDLY



Shown with optional base covers



Configure your Netting System

Step 1 Pick Your Pole

System Height and Pole Style:

10 ft. Straight	Heavy-wall 2-3/8" O.D., Aluminum Tube	FN-10
15 ft. Straight	Heavy-wall 4.0" O.D. Aluminum Tube	FN-15
20 ft. Straight	Heavy-wall 4.0" O.D. Aluminum Tube	FNS-20
20 ft. Offset	Heavy-wall 4.0" O.D. Aluminum Tube	FNO-20
30 ft. Straight	Heavy-wall 6-5/8" O.D. Aluminum Tube	FNS-30
12 ft. Portable	Heavy-wall 2-3/8" O.D., Aluminum Tube	PFN-12

Step 2 Pick Your Net

Nets:

- A** Multi-Sport, 1-3/4", #36 knotted nylon sq. mesh, UV treated, with 1/4" rope border
- B** Soccer/Football, 3-1/2", #36 knotted nylon sq. mesh, UV treated, with 1/4" rope border
- C** 1-3/4" knot-less HTPP sq. mesh, UV treated, with 1/4" rope border
- D** 4" knot-less HTPP sq. mesh, UV treated, with 1/4" rope border

Step 3 Determine Length & Build your System

EXAMPLE:

15 ft. Straight Pole: **FN-15**
with a Multi-Sport nylon net: **A**
Would like it to be 180 feet long...

This would be my item number: **FN-15-A x 180'**

Step 5

Call Jaypro
(800) 243-0533
for Pricing Details
and Information!

Step 4 Options to Consider

Portable System Base Covers (standard color is red)

PFN-BCVR 2 lbs. \$49 each

In-Ground Pole Option: Powder Coated Black Finish (Please Specify)



NEW



Basic Portable Field Netting Package

PFN-1260PKG

12'H x 60'L Portable Netting System (includes 4 black powder coated poles, 4 bases, 16 five gallon jugs, 1-3/4" knotted nylon net, hardware and 4 vinyl base covers)

567 lbs.

\$3,295 package

FieldPro Discus Cage



NEW

High School Discus cage. Consists of (6) offset poles, made of heavy wall 4" aluminum pipe. Poles are 14'6" H and have a 24" offset to minimize ricochet. Net is heavy duty weather treated black nylon, with a 1-7/8" mesh. Net measures 14'H x 54'L and comes with ground anchors to hold net in place at all times. Includes a pulley hoisting system that allows for easy net removal and set-up, as well as ground sleeves and covers, for complete system removal during the off season. Meets all NFHS rules and regulations, and is designed to accommodate a 34.92 degree throwing sector. **Optional 7'H Perimeter Barrier net, for added layer of protection.**

DCHS-35
DCPN-7

Discus Cage
Perimeter Net

Call for Pricing
Call for Pricing

Aluminum Tip & Roll Standard Bleacher



BLCH-4TRG

Tip and Roll Bleacher

All aluminum seat planks and understructure provide a lightweight, stable bleacher that is easily tipped for easy mobility. Seat planks are 10" wide non-skid aluminum. Transition foot prevents floor marking. Includes (4) 4" non-marring swivel casters. **Preferred bleachers are the same as our standard aluminum bleachers but with the addition of double foot planks on all rows.** Four row bleachers do not exceed 30" in height, therefore guard rails may not be needed! (Check your local codes).



STANDARD FOOT PLANKS NATURAL FINISH



STANDARD FOOT PLANKS POWDER COATED COLORS



Standard Natural Finish Bleachers					
Rows	Length	Seats	Item #	Price	Weight
2	7-1/2'	10	BLCH-275TRG	\$749	75 lbs.
	15'	20	BLCH-2TRG	\$1,099	135 lbs.
	21'	30	BLCH-221TRG	\$1,449	180 lbs.
	27'	38	BLCH-227TRG	\$1,749	225 lbs.
3	7-1/2'	15	BLCH-375TRG	\$999	118 lbs.
	15'	30	BLCH-3TRG	\$1,399	210 lbs.
	21'	42	BLCH-321TRG	\$1,799	270 lbs.
	27'	54	BLCH-327TRG	\$2,299	330 lbs.
4	7-1/2'	20	BLCH-475TRG	\$1,299	155 lbs.
	15'	40	BLCH-4TRG	\$1,999	310 lbs.
	21'	52	BLCH-421TRG	\$2,349	415 lbs.
	27'	70	BLCH-427TRG	\$2,699	520 lbs.

Standard Powder Coated Bleachers					
Rows	Length	Seats	Item #	Price	Weight
2	7-1/2'	10	BLCH-275TRGPC	\$829	75 lbs.
	15'	20	BLCH-2TRGPC	\$1,195	135 lbs.
	21'	30	BLCH-221TRGPC	\$1,599	180 lbs.
	27'	38	BLCH-227TRGPC	\$1,999	225 lbs.
3	7-1/2'	15	BLCH-375TRGPC	\$1,149	118 lbs.
	15'	30	BLCH-3TRGPC	\$1,549	210 lbs.
	21'	42	BLCH-321TRGPC	\$1,995	270 lbs.
	27'	54	BLCH-327TRGPC	\$2,499	330 lbs.
4	7-1/2'	20	BLCH-475TRGPC	\$1,449	155 lbs.
	15'	40	BLCH-4TRGPC	\$2,099	310 lbs.
	21'	52	BLCH-421TRGPC	\$2,599	415 lbs.
	27'	70	BLCH-427TRGPC	\$3,199	520 lbs.



BLCH-3TRGPC

NEW VOLLEYBALL SOCCER FOOTBALL LACROSSE BASEBALL FIELD MARKING SCOREBOARD BASKETBALL GYMNASIUM FIELD SEATING BALL STORAGE PHYS. ED. TENNIS





BLDP-4TRGPC

Tip and Roll Bleacher

All aluminum seat planks and understructure provide a lightweight, stable bleacher that is easily tipped for easy mobility. Seat planks are 10" wide non-skid aluminum. Transition foot prevents floor marking. Includes (4) 4" non-marring swivel casters. **Preferred bleachers are the same as our standard aluminum bleachers but with the addition of double foot planks on all rows.** Four row bleachers do not exceed 30" in height, therefore guard rails may not be needed! (Check your local codes). Show your team or school pride with powder coated bleachers. See chart for available colors on both the planks and understructure.

PREFERRED DOUBLE FOOT PLANKS NATURAL FINISH



PREFERRED DOUBLE FOOT PLANKS POWDER COATED COLORS

Preferred Natural Finish Bleachers					
Rows	Length	Seats	Item #	Price	Weight
2	7-1/2'	10	BLDP-275TRG	\$869	100 lbs.
	15'	20	BLDP-2TRG	\$1,249	170 lbs.
	21'	30	BLDP-221TRG	\$1,669	230 lbs.
	27'	38	BLDP-227TRG	\$2,049	290 lbs.
3	7-1/2'	15	BLDP-375TRG	\$1,199	150 lbs.
	15'	30	BLDP-3TRG	\$1,649	265 lbs.
	21'	42	BLDP-321TRG	\$2,099	360 lbs.
	27'	54	BLDP-327TRG	\$2,449	455 lbs.
4	7-1/2'	20	BLDP-475TRG	\$1,649	210 lbs.
	15'	40	BLDP-4TRG	\$2,399	405 lbs.
	21'	52	BLDP-421TRG	\$2,849	540 lbs.
	27'	70	BLDP-427TRG	\$3,299	675 lbs.

Preferred Powder Coated Bleachers					
Rows	Length	Seats	Item #	Price	Weight
2	7-1/2'	10	BLDP-275TRGPC	\$899	100 lbs.
	15'	20	BLDP-2TRGPC	\$1,349	170 lbs.
	21'	30	BLDP-221TRGPC	\$1,849	230 lbs.
	27'	38	BLDP-227TRGPC	\$2,249	290 lbs.
3	7-1/2'	15	BLDP-375TRGPC	\$1,249	150 lbs.
	15'	30	BLDP-3TRGPC	\$1,799	265 lbs.
	21'	42	BLDP-321TRGPC	\$2,299	360 lbs.
	27'	54	BLDP-327TRGPC	\$2,849	455 lbs.
4	7-1/2'	20	BLDP-475TRGPC	\$1,799	210 lbs.
	15'	40	BLDP-4TRGPC	\$2,449	405 lbs.
	21'	52	BLDP-421TRGPC	\$3,149	540 lbs.
	27'	70	BLDP-427TRGPC	\$3,699	675 lbs.



BLDP-4TRG

Color Choices for Bleachers



Plank and understructure colors shown. Please specify plank and understructure color when ordering.



NEW VOLLEYBALL SOCCER FOOTBALL LACROSSE BASEBALL FIELD MARKING SCOREBOARD BASKETBALL GYMNASIUM FIELD SEATING BALL STORAGE PHYS. ED. TENNIS



All Aluminum Bleacher

All aluminum seat planks and understructure provide a lightweight, stable bleacher. Seat planks are 10" wide non-skid aluminum. Four row bleachers do not exceed 30" in height, therefore guard rails may not be needed! (Check your local codes).



STANDARD FOOT PLANKS NATURAL FINISH



STANDARD FOOT PLANKS POWDER COATED COLORS



Standard Natural Finish Bleachers					
Rows	Length	Seats	Item #	Price	Weight
3	15'	30	BLCH-3AL	\$1,349	240 lbs.
	21'	42	BLCH-321AL	\$1,699	340 lbs.
	27'	54	BLCH-327AL	\$2,199	440 lbs.
4	15'	40	BLCH-4AL	\$1,899	320 lbs.
	21'	52	BLCH-421AL	\$2,299	440 lbs.
	27'	70	BLCH-427AL	\$2,649	560 lbs.

Standard Powder Coated Bleachers					
Rows	Length	Seats	Item #	Price	Weight
3	15'	30	BLCH-3ALPC	\$1,449	240 lbs.
	21'	42	BLCH-321ALPC	\$1,949	340 lbs.
	27'	54	BLCH-327ALPC	\$2,449	440 lbs.
4	15'	40	BLCH-4ALPC	\$2,049	320 lbs.
	21'	52	BLCH-421ALPC	\$2,549	440 lbs.
	27'	70	BLCH-427ALPC	\$2,999	560 lbs.



CONVERT YOUR EXISTING OUTDOOR BLEACHERS TO INDOOR!

Indoor Conversion Kit for 2, 3 and 4-Row Bleachers

Set of 12 rubber feet to attach to bottom of legs. Sturdy design allows for converting 7-1/2', 15', 21' or 27' Aluminum Bleachers from outdoor to indoor use.



BLCHICK34

4 lbs.

\$49 set



Aluminum Outdoor Preferred Bleacher



BLDP-4AL

All Aluminum Bleacher

All aluminum seat planks and understructure provide a lightweight, stable bleacher. Seat planks are 10" wide non-skid aluminum. **Preferred bleachers are the same as our standard aluminum bleachers but with the addition of double foot planks on all rows.** Four row bleachers do not exceed 30" in height, therefore guard rails may not be needed! (Check your local codes). Show your team or school pride with powder coated bleachers. See chart for available colors on both the planks and understructure.

PREFERRED DOUBLE FOOT PLANKS NATURAL FINISH



PREFERRED DOUBLE FOOT PLANKS POWDER COATED COLORS

Preferred Natural Finish Bleachers					
Rows	Length	Seats	Item #	Price	Weight
3	15'	30	BLDP-3AL	\$1,549	290 lbs.
	21'	42	BLDP-321AL	\$1,899	415 lbs.
	27'	54	BLDP-327AL	\$2,349	540 lbs.
4	15'	40	BLDP-4AL	\$2,299	395 lbs.
	21'	52	BLDP-421AL	\$2,799	550 lbs.
	27'	70	BLDP-427AL	\$3,249	705 lbs.

Preferred Powder Coated Bleachers					
Rows	Length	Seats	Item #	Price	Weight
3	15'	30	BLDP-3ALPC	\$1,749	290 lbs.
	21'	42	BLDP-321ALPC	\$2,249	415 lbs.
	27'	54	BLDP-327ALPC	\$2,799	540 lbs.
4	15'	40	BLDP-4ALPC	\$2,499	395 lbs.
	21'	52	BLDP-421ALPC	\$3,099	550 lbs.
	27'	70	BLDP-427ALPC	\$3,449	705 lbs.

Color Choices for Bleachers

Plank and understructure colors shown. Please specify plank and understructure color when ordering.



BLDP-4ALPC



**144 Possible
Color Combinations!**

Jaypro's four row bleachers may not require guard rails since the height is less than 30" from the ground. Check your local requirements.

Four Row Bleacher

NEW VOLLEYBALL SOCCER FOOTBALL LACROSSE BASEBALL FIELD MARKING SCOREBOARD BASKETBALL GYMNASIUM FIELD SEATING BALL STORAGE PHYS. ED. TENNIS

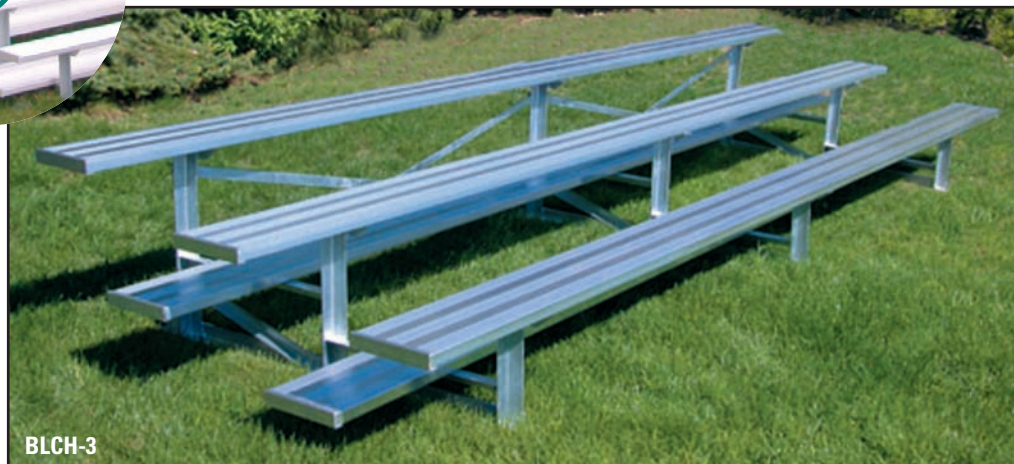

BLCH-3

Outdoor Aluminum and Steel Bleachers

All aluminum seat planks and galvanized steel understructure provide a lightweight, stable bleacher. Seat planks are 10" wide non-skid aluminum. Planks are supported by a strong, galvanized steel understructure made of 3/16" x 1-1/2" steel angle. Dual braces and rear stabilizing bar are included for additional strength and stability.

Color Choices for Bleachers

Plank and understructure colors shown. Please specify plank and understructure color when ordering.

STANDARD FOOT PLANKS NATURAL FINISH



STANDARD FOOT PLANKS POWDER COATED COLORS

Standard Natural Finish Bleachers					
Rows	Length	Seats	Item #	Price	Weight
3	15'	30	BLCH-3	\$1,299	305 lbs.
	21'	42	BLCH-321	\$1,649	425 lbs.
	27'	54	BLCH-327	\$2,149	545 lbs.
4	15'	40	BLCH-4	\$1,849	390 lbs.
	21'	52	BLCH-421	\$2,299	520 lbs.
	27'	70	BLCH-427	\$2,649	650 lbs.

Standard Powder Coated Bleachers					
Rows	Length	Seats	Item #	Price	Weight
3	15'	30	BLCH-3PC	\$1,449	305 lbs.
	21'	42	BLCH-321PC	\$1,899	425 lbs.
	27'	54	BLCH-327PC	\$2,399	545 lbs.
4	15'	40	BLCH-4PC	\$1,999	390 lbs.
	21'	52	BLCH-421PC	\$2,499	520 lbs.
	27'	70	BLCH-427PC	\$2,949	650 lbs.



7' Bleacher or Bench Plank Pad

Create comfortable seating for your players or spectators. Simply buckle the straps under the plank for installation. Pads are 7'L x 10"W x 1-3/8" thick. Designed for 7-1/2', 15' (requires 2 pads) or 21' (requires 3 pads) planks. Please specify color when ordering. Extended lead time may apply. Does not ship from Jaypro's CT warehouse. Call for freight quote.

PLKPAD7 5 lbs. **\$125 each**

Available Colors

Navy	Dk Purple	Pink	Lime	Kelly Green	Lt Blue
Royal Blue	Forest Green	Yellow	Orange	Red	Burgundy
Brown	Beige	White	Gray	Charcoal	Black



Bleacher Transport Kit

Move your bleachers from field to field. Fits any angle framed 2, 3, 4 or 5 row bleacher, 15', 21' or 27' long. Includes two 4.8" x 12" wheels. Wheels and tongue are easily removed when not in use. Additional mounting brackets and axle receivers for additional bleachers purchased separately.

BLCH-TOW4515	15' Long	\$795 each
BLCH-TOW4521	21'-27' Long	\$895 each
BLCH-TMKIT	Mounting Kit	\$229 each



Powder Coat Your Bleachers!

Color your Planks... Color your Hand Rails... Color your Understructure... Color your Enclosure... We Dare the Competition to Match That!



Bleachers with Guard Rail or Chain Link with or without Aisle

All aluminum seat planks and galvanized steel understructure provide a lightweight, stable bleacher. Seat planks are 10" wide non-skid aluminum. Planks are supported by a strong, galvanized steel understructure made of 3/16" x 1-1/2" steel angle. Dual braces and rear stabilizing bar are included for additional strength and stability. Risers and double foot planks above 30" for added safety. Aisle option includes a 2" O.D. handrail in the center of the bleacher. Show your team or school pride with powder coated bleachers. **See chart for available colors on the planks, understructure and guard rails.**



			Standard Natural Finish Bleachers				Powder Coated Bleachers	
Rows	Length	Seats	Enclosure	Item #	Price	Weight	Item #	Price
5	15'	50	Guard Rail	BLCH-5GR	\$4,895	1172 lbs.	BLCH-5GRPC	\$5,399
	15'	50	Chain Link	BLCH-5C	\$4,295	1012 lbs.	N/A	N/A
	21'	62	Guard Rail	BLCH-521GR	\$5,495	1452 lbs.	BLCH-521GRPC	\$6,995
	21'	62	Chain Link	BLCH-521C	\$5,215	1252 lbs.	N/A	N/A
	21'	58	Guard Rail w-Aisle	BLCH-521ASGR	\$7,495	1500 lbs.	BLCH-521ASGRPC	\$8,295
	27'	80	Guard Rail	BLCH-527GR	\$6,995	1732 lbs.	BLCH-527GRPC	\$7,449
10	27'	80	Chain Link	BLCH-527C	\$5,995	1492 lbs.	N/A	N/A
	15'	100	Guard Rail	BLCH-10GR	\$10,995	2500 lbs.	N/A	N/A
	21'	140	Guard Rail	BLCH-1021GR	\$13,995	2700 lbs.	N/A	N/A
	21'	114	Guard Rail w-Aisle	BLCH-1021ASGR	\$15,495	3000 lbs.	N/A	N/A
	27'	170	Guard Rail	BLCH-1027GR	\$16,995	3464 lbs.	N/A	N/A
	27'	134	Guard Rail w-Aisle	BLCH-1027ASGR	\$17,995	3700 lbs.	N/A	N/A



Any Color Combination of Plank, Understructure or Guard Rail on our 5 Row Bleachers!

COLORS

Bring Your Existing Five Row Bleachers Up To Local Codes With Jaypro's Universal Enclosure!

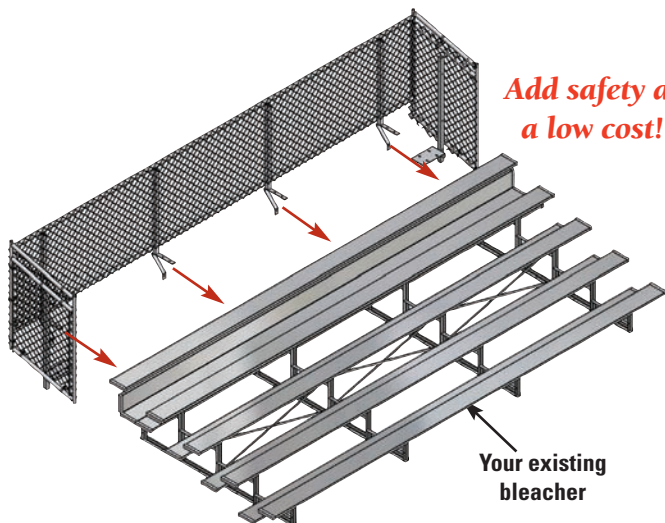

Add safety at a low cost!

Universal Enclosure For Five Row Bleacher

Comply with your local safety code by adding a chain link enclosure to your existing five row bleacher. Bolts onto 15', 21' or 27' bleachers. Fits most bleachers.

This enclosure will ensure no exposed seat is higher than 30" and comes with a footboard and kickboard to complete the upgrade!

Univ. Encl for 5-Row 15' Bleacher BLCH5CUE15	250 lbs.	\$2,295 each
Univ. Encl for 5-Row 21' Bleacher BLCH5CUE21	275 lbs.	\$2,895 each
Univ. Encl for 5-Row 27' Bleacher BLCH5CUE27	300 lbs.	\$3,695 each



NEW VOLLEYBALL SOCCER FOOTBALL LACROSSE BASEBALL FIELD MARKING SCOREBOARD BASKETBALL GYMNASIUM FIELD SEATING BALL STORAGE PHYS. ED. TENNIS

Player Benches

48 HOUR QUICK SHIP



Three Mounting Choices:

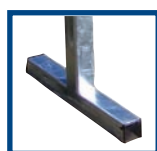

Portable Mounting

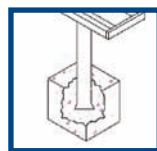

Permanent Installation

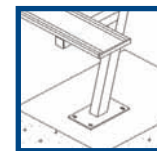

Surface Mounting

Player Benches

Constructed of 10" wide non skid aluminum seat planks and 2" x 2" heavy duty, galvanized steel legs for superior rust resistance and superior stability. Available with or without a seat back in your choice of portable, permanent or surface installed units. Jaypro player benches are available powder coated in team or school colors - a durable and attractive finish that is scratch resistant and long lasting. A floor protection kit is available for indoor use, see below. All but the 7-1/2' models ship by truck. **Natural finish standard benches ship within 48 hours.**

Length	Natural Finish Without Seat Back				Natural Finish With Seat Back					
	Mounting Configuration			Price	Weight	Mounting Configuration			Price	Weight
Portable	Permanent	Surface	Portable			Permanent	Surface			
7-1/2'	PB-75	PB-75PI	PB-75SM	\$239	33 lbs.	PB-80	PB-80PI	PB-80SM	\$339	60 lbs.
15'	PB-15	PB-15PI	PB-15SM	\$329	57 lbs.	PB-20	PB-20PI	PB-20SM	\$539	100 lbs.
21'	PB-5	PB-5PI	PB-5SM	\$449	79 lbs.	PB-10	PB-10PI	PB-10SM	\$689	135 lbs.
27'	PB-95	PB-95PI	PB-95SM	\$519	101 lbs.	PB-90	PB-90PI	PB-90SM	\$769	175 lbs.



Color Choices for Benches



Plank and leg colors shown. Please specify plank and leg color when ordering.

Jaypro Team Colored Benches are available in an unbelievable 144 Possible Combinations!



Optional Floor Protector Kit

Optional floor protector kit ensures that your gym floors will not get scratched! Self-threading screws with 4 rubber feet. Two feet needed per leg.

PSS-4FT

2 lbs.

\$29 kit



When ordering, please specify leg and plank colors.

Length	Powder Coated Without Seat Back				Powder Coated With Seat Back					
	Mounting Configuration			Price	Weight	Mounting Configuration			Price	Weight
Portable	Permanent	Surface	Portable			Permanent	Surface			
7-1/2'	PB-75PC	PB-75PIPC	PB-75SMPC	\$309	33 lbs.	PB-80PC	PB-80PIPC	PB-80SMPC	\$449	60 lbs.
15'	PB-15PC	PB-15PIPC	PB-15SMPC	\$389	57 lbs.	PB-20PC	PB-20PIPC	PB-20SMPC	\$679	100 lbs.
21'	PB-5PC	PB-5PIPC	PB-5SMPC	\$519	79 lbs.	PB-10PC	PB-10PIPC	PB-10SMPC	\$809	135 lbs.
27'	PB-95PC	PB-95PIPC	PB-95SMPC	\$619	101 lbs.	PB-90PC	PB-90PIPC	PB-90SMPC	\$909	175 lbs.



Pro-Player Bench

Similar to our Standard Player Benches but with extra support and comfort to accommodate pro level players! We have added additional leg supports and cross bracing for strength. The Aluminum seat plank is larger at 12"W, 20"H and contoured for comfort. Our 2" x 2" square heavy duty galvanized steel legs offer superior stability. **Powder coat your bench for a custom look!** Please specify plank and leg color choice/s when ordering.



Contoured 12" seat plank sits 3" higher than a standard bench.

Additional leg support and cross bracing for added strength.



PB-20PROPC

Length	Natural Finish Pro-Player Bench			Powder Coated Pro-Player Bench	
	Item #	Price	Weight	Item #	Price
15'	PB20-PRO	\$999	124 lbs.	PB20-PROPC	\$1,149
21'	PB10-PRO	\$1,199	161 lbs.	PB10-PROPC	\$1,399

PBS-80



Powder coat your bench for a custom look! When ordering, please specify colors for planks and legs.



PBS-20PC

Players Bench with Shelf

10" wide non-skid aluminum planks and 2" x 2" heavy duty galvanized steel legs for superior rust resistance. The 20" wide shelf can be used for helmets, gloves, water and other miscellaneous items. Same high quality as our full line of player benches. **Natural finish standard benches ship within 48 hours.**

Length	Natural Finish Players Bench with Shelf			Powder Coated Players Bench with Shelf	
	Item #	Price	Weight	Item #	Price
7-1/2'	PBS-80	\$519	95 lbs.	PBS-80PC	\$629
15'	PBS-20	\$759	130 lbs.	PBS-20PC	\$969
21'	PBS-10	\$999	185 lbs.	PBS-10PC	\$1,359
27'	PBS-90	\$1,599	240 lbs.	PBS-90PC	\$1,949

Wall Mounted Aluminum Players Bench

10" wide non-skid aluminum planks with corrosion resistant aluminum under structure. The under structure is mounted to the wall with stainless steel hardware. **Powder coat your bench for a custom look!** Please specify plank and under structure color choice/s when ordering.



PBW-95PC

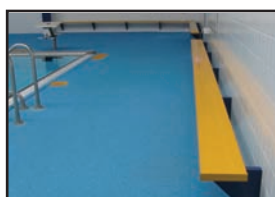

Length	Natural Finish			Powder Coated	
	Item #	Price	Weight	Item #	Price
7-1/2'	PBW-75	\$299	20 lbs.	PBW-75PC	\$339
15'	PBW-15	\$359	40 lbs.	PBW-15PC	\$419
21'	PBW-5	\$469	60 lbs.	PBW-5PC	\$549
27'	PBW-95	\$530	80 lbs.	PBW-95PC	\$649



ST75PC

Scorers Table

Top quality, aluminum scorers table. 7.5'L x 10"W Aluminum seat and 19" wide table top. 2" x 2" heavy-duty galvanized steel legs for superior rust resistance. Same high quality as our full line of player benches. **Powder coat your table for a custom look!** Please specify plank and leg color choice/s when ordering.

Length	Natural Finish	Natural Finish Price	Powder Coated	Powder Coated Price	Weight
7-1/2'	ST75	\$489	ST75PC	\$579	90 lbs.

Storage Carts

NEW VOLLEYBALL SOCCER FOOTBALL LACROSSE BASEBALL FIELD MARKING SCOREBOARD BASKETBALL GYMNASIUM FIELD SEATING BALL STORAGE PHYS. ED. TENNIS



TE-2

Holds approximately 20-25 balls



Can be used indoors or outdoors!

Great for pool areas!



TE-2

ToteMaster™ – The Original!

All-purpose carrier provides large holding capacity for all types of equipment. Rugged construction features include 3/16" all-welded steel powder coated wire with 3" square mesh, four heavy duty swivel wheels and a hinged cover that can be locked for secure storage. 3'L x 2'W x 3'H.

TE-2

48 lbs.

\$239 each



Just pop open, put on the wheels and go!

No assembly required!



TE-30

Mini ToteMaster™

Same construction features as the TE-2 except the overall size is 21" L x 21" W x 30" H.

TE-30

26 lbs.

\$159 each

ToteMaster™ with All Terrain Wheels!

All the great features of the original Totemaster, except with two heavy duty swivel wheels and two fixed all terrain wheels. Now you can use your carrier outdoors!

AT-5

63 lbs.

\$299 each



AT-5



TE-60

Best Seller!

ToteMaster™ Plus

This larger version of the Original Totemaster™ unit features an internal divider to keep equipment separate and a split top for easy opening and closing of the unit. The rugged construction features 3/16" all-welded steel powder coated wire with 3" square mesh and upgraded, larger heavy duty swivel wheels. The cover can also be locked for secure storage. 5'L x 2'W x 3'H.

TE-60

76 lbs.

\$325 each





AT-10

ToteMaster™ - FieldCart

All purpose carrier provides large holding capacity for all types of equipment. Constructed of 3/16" all welded steel powder coated wire with 3" square mesh. Includes 6" semi-pneumatic front swivel casters and 20" semi-pneumatic all terrain rear wheels providing 10" of ground clearance. Lockable hinged cover.

Overall size: 51"L x 48"H x 25"W
Basket size: 41"L x 27"H x 23"W

AT-10 65 lbs. **\$389 each**

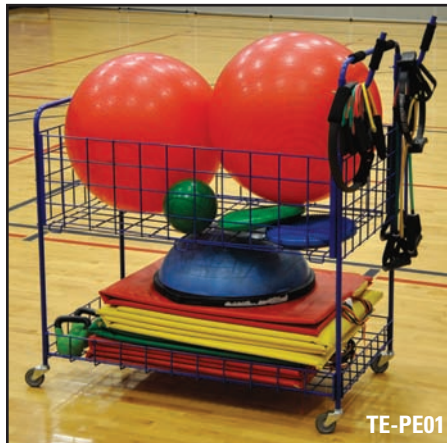

TE-PE01

ToteMaster™ - Open Top Storage Cart

Two full size open top storage baskets for various equipment storage, mesh is 4"x 3". Two 360° hangers rotate for hoop and jump rope storage. Swivel casters for easy indoor transport. Powder coated frame for extra durability. Optional side shelf available separately for additional storage. Size: 48"L x 26"W x 54"H.

TE-PE01 48 lbs. **\$249 each**

TE-PESHELF 2 lbs. **\$16 each**



TE-PE02

ToteMaster™

Deluxe Open Top Storage Cart

Same as the TE-PE01 except includes large all terrain wheels, has four 360° hangers and one side storage shelf. Additional storage shelves are available separately. Size: 48"L x 26"W x 58"H.

TE-PE02 56 lbs. **\$299 each**

Atlas Series



BBABL-1

Rugged 1" square steel

Non marking swivel casters



BBABL-2



Includes Mesh Hamper Liner

Constructed of thick wall 1" steel tube. These units are rugged and strong enough for an assortment of medicine balls. Heavy duty non marking swivel casters for easy transport. Protective powder coating (blue) for longer life.



ToteMaster™ "Atlas" Ball Locker

This unit is lockable with customer supplied lock, and a hinged top. Will store up to 28 basketballs and up to 35 volleyballs. Assembles to 47"L x 24"W x 37"H.

BBABL-1 75 lbs. **\$359 each**

ToteMaster™ - Ball Locker & Hamper

Constructed of 1" round steel tube. Comes with mesh liner kit. Powder coated blue for tough surface protection. Larger 8" all terrain wheels with directional swivels allow for outside use. Stores up to 28 basketballs. Hamper liner makes for excellent storage for towels or uniforms. This unit is lockable with customer supplied lock. Assembles to 45"L x 24"W x 35"H.

BBABL-2 Locker 60 lbs. **\$369 each**



BBABC-1



BBABC-2

ToteMaster™ - "Atlas" Ball Cart

The multiple level racks store up to 15 balls. Constructed of 1" square steel. Includes four non marking swivel casters. Assembles to 51-1/2"L x 18"W x 36"H.

BBABC-1 30 lbs. **\$239 each**

ToteMaster™ - "Atlas" Double Ball Cart

The multiple level racks store up to 30 balls. Constructed of 1" square steel. Includes four non marking swivel casters. Assembles to 51.5"L x 24"W x 36"H.

BBABC-2 55 lbs. **\$339 each**

DELUXE BASKETBALL CARRIERS

The most rugged and durable carriers available today. Innovative easy access design holds up to 12 or 18 basketballs. All welded 1" O.D. steel side frames. 1" O.D. steel crossbars. Four heavy-duty swivel casters for portability. Tough powder coated finish. **Lifetime Warranty on frame and casters!**

Twelve Ball Carrier

36"H x 22"W x 39"L

- BBC-12RB** Royal Blue
- BBC-12BK** Black
- BBC-12RD** Red

27 lbs. **\$149 each**

LIFETIME WARRANTY!
Jaypro's basketball carriers are the most durable in the industry, we stand on it!



All welded side frames



BBC-12RB

Your choice of three colors!

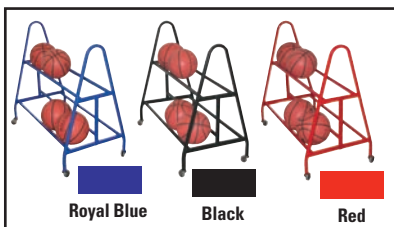

Royal Blue Black Red

Eighteen Ball Carrier

36"H x 22"W x 60"L

- BBC-18RB** Royal Blue
- BBC-18BK** Black
- BBC-18RD** Red

41 lbs. **\$172 each**

Also holds
Volleyballs and
Medicine Balls



DTBR-19

StackMaster™ Double Basketball and Volleyball Wall Storage Rack

Holds up to 16 basketballs or 30 volleyballs securely in a lockable steel rack. Locking bars at top and bottom to secure balls after loading. Locks not included. 1" steel tubing is powder coated black. Does not include mounting hardware. Size: 66"H x 32"W x 13"D.

PE-240 20 lbs. **\$179 each**

StackMaster™ Basketball Wall Storage Rack

Holds up to 6 basketballs securely in a lockable steel rack. Locking bars at top and bottom to secure balls after loading. 1" steel tubing is powder coated black. Does not include mounting hardware. Size: 66"H x 15"W x 12"D.

PE-140 13 lbs. **\$109 each**



PE-240



PE-140

Deluxe Training Ball Rack

Durable ball rack designed to feed the top seven balls to the shooter. Excellent for shooting competitions and free throw practice. Holds 19 regulation basketballs. Strong 1" O.D. powder coated black tubing on rails and ends. Special extra-heavy duty non-marking wheels (front two are lockable). Assembles to 44"H x 18"W x 61"L.

DTBR-19 45 lbs. **\$199 each**

NOTE: Due to differences in wall construction, Jaypro does not provide anchors or mounting hardware to attach the wall stringers to gym walls. Consult your architect or contractor to determine the best and safest installation methods for your facility.



Wide-Body Ball Carts

BC3 holds 12 balls or BC4 holds 16 balls with a wide body design for stability. Heavy duty steel frame with chrome finish. Easy assembly.

Three-Tier
39-1/2"H x 8-1/2"W x 39"L

BC3 15 lbs. **\$70 each**

Four-Tier
39-1/2"H x 8-1/2"W x 51-1/2"L

BC4 19 lbs. **\$75 each**



BC3



BC4

NEW VOLLEYBALL SOCCER FOOTBALL LACROSSE BASEBALL FIELD MARKING SCOREBOARD BASKETBALL GYMNASIUM FIELD SEATING BALL STORAGE PHYS. ED. TENNIS





Do you know what's living on your sports balls?

Yuck! Sport balls are notorious for picking up and spreading germs and bacteria that can cause infections such as, MRSA, Whooping Cough, Pink Eye, STAPH, H1N1, Influenza and many other harmful diseases. It's a health risk! Is this what you want circulating through your sports program?



These images are actual culture samples from schools around the United States.

*The **germninja**® is designed to kill germs on sports balls and protect students/athletes of all ages from bacteria and viruses that cause disease.*

CHEMICAL FREE!

We use the same technology that Operating Rooms use to sterilize its equipment, but we apply it to a sports ball. Jaypro sanitizes sports balls with ultraviolet light, killing off harmful micro-organisms without ruining the surface of the ball.

Safe for all sports balls, leaves no residue behind!



"Germninja is a revolutionary product that will help protect your athletes from viruses. It's a proven and effective way to help prevent germs spreading within your Team."

Hugh McCutchen, Head Coach
University of Minnesota

germninja®

*The **germninja**® Ultraviolet Sports Ball Sanitizer is your teams defense against bacteria and germs that cause contagious infections.*

Kills bacteria and germs that can cause Strep, Staph, H1N1, E.coli, Salmonella, MRSA, Influenza, Whooping Cough, and other contagious infections. Chemical free nontoxic technology that is made in the USA. 50% of plastic used in this device is made from recycled materials. Safe for all sports balls, leaves no residue behind. Unique design allows balls to roll past the sanitizing lights to ensure every nook and cranny is disinfected. An optional cover is available for the unit, call for details and pricing. Call Customer Service for information on sponsoring a **germninja**® for your school system!

GNJA1

150 lbs.

\$2,295 each



*Keep your sports balls clean and sanitized after passing through the **germninja**® - store them in one of these two **germninja**® carts. Each cart includes an antimicrobial liner made with Argent 47, a specially woven silver embedded fabric, which has natural antimicrobial properties.*



TENINJA-SPLIT
Half Liner 51 lbs.

\$289 each

TENINJA-CART
Full Liner 52 lbs.

\$389 each

Patent Pending

jaypro GymGlide™

RECREATIONAL GAME STANDARD

NEW VOLLEYBALL SOCCER FOOTBALL LACROSSE BASEBALL FIELD MARKING SCOREBOARD BASKETBALL GYMNASIUM FIELD SEATING BALL STORAGE PHYS. ED. TENNIS



Jaypro GymGlide™ Recreational Game Standard

Never tip to move or store! Equal to a 220 lb game standard. Telescoping upright includes lever-released composite height adjustment collars. Powder coated cast iron base rides on retractable front swivel wheels. Available in 5 base colors: Royal Blue, Dark Green, Yellow, Red and White.

	Royal Blue	GGG-100RB	170 lbs.	\$598 each
	Dark Green	GGG-100DG	170 lbs.	\$598 each
	Yellow	GGG-100YW	170 lbs.	\$598 each
	Red	GGG-100RD	170 lbs.	\$598 each
	White	GGG-100W	170 lbs.	\$598 each



See page 113 for GymGlide Nets

From Gym to Storage in 4 Easy Steps!



Engage Wheels

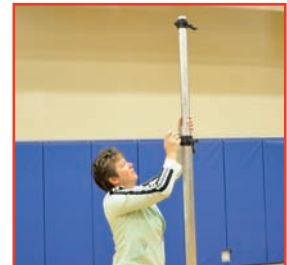

Slide Down Telescopic Upright



Roll to Storage



Store Safely



Never Tip to Move!
Never Tip to Store!

Telescoping Aluminum Upright!

Unique Design: 155 lb. base with holding capacity equivalent to standard 220 lb. bases!

GymGlide Base Color Choices:



Scan to follow us online!



Tough Powder Coated Cast Iron Base

GGG-100RB



GymGlide Packages

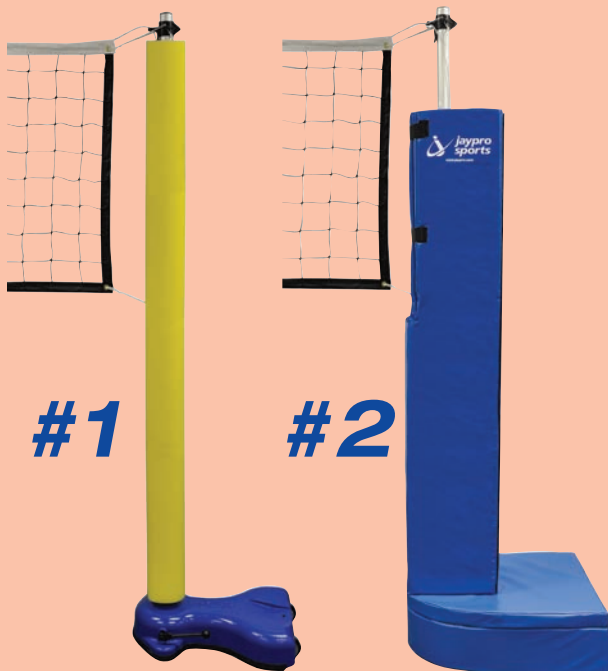

GymGlide Package #1

- 2 each **GG-100XX*** GymGlide Game Standard
- 2 each **GG-UPAD** GymGlide Upright Pad
- 1 each **VBN-32** Volleyball Net

A SAVINGS OF \$129

Priced Separately at \$1,398

GG-100PKG

348 lbs.

\$1,269 package

* Please Specify Color

GymGlide Package #2

- 2 each **GG-100XX*** GymGlide Game Standard
- 2 each **GG-BPAD*** GymGlide Base Pad
- 2 each **PVB60PHP*** GymGlide Post Pad
- 1 each **VBN-32** Volleyball Net

A SAVINGS OF \$205

Priced Separately at \$2,324

GG-100PKGDX

372 lbs.

\$2,119 package

* Please Specify Color



GG-BPAD

GymGlide Base Pad

Fits GymGlide game standard. 2" thick foam pad covered with vinyl. Available in royal blue, forest green, yellow and red.

GG-BPAD 5 lbs.

\$259 each

Pad Color Choices Colors displayed may not be an exact match



STANDARD NETS



Volleyball Net
Nylon, rope cable
36"W x 32'L

VBN-32 4 lbs.

\$92 each



Badminton Net
Lightweight, rope cable
30"W x 21'L

BND-1 5 lbs.

\$52 each



Tennis Net
Lightweight, rope cable
39"W x 42'L

TDP-42 7 lbs.

\$148 each

GymGlide Economy Upright Pad

Fits GymGlide uprights. 2" thick foam pads are pre-slit for easy installation. Comes in an 8' section and can be cut in the field. Available in safety yellow.

GG-UPAD 2 lbs. **\$55 each**

Deluxe Post Pad

2" thick foam pad covered with vinyl. Hook-and-loop attachment. See to right for available colors.

PVB60PHP 9 lbs. **\$259 each**

NEW VOLLEYBALL SOCCER FOOTBALL LACROSSE BASEBALL FIELD MARKING SCOREBOARD BASKETBALL GYMNASIUM FIELD SEATING BALL STORAGE PHYS. ED. TENNIS

Multi-Purpose Game Standards

The most versatile piece of gymnasium equipment available. Standards set up in minutes and provide a wide range of fun-filled activities for any age group. Steel bases are 24" diameter & available in 3 sizes: 75 lb., 145 lb. and 220 lb. Uprights are 2" diameter x 10' high (two piece). Exclusive safety hub. Includes sliding eye bolt collars that allow for easily adjustable net heights. Bases include rubber rims to protect floor and two 4" non-marring wheels for easy portability.

See page 113 for Nets.

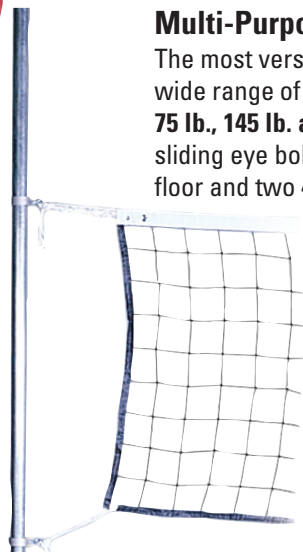

Easily adjust the net height with sliding collars



Game standards tip and roll for easy portability!

MP-521R

48 HOUR QUICK SHIP

Item	Size in lbs.	Color	Weight	Price
AS-475R	75	Royal Blue	203 lbs.	\$629 pair
AS-475RR	75	Red	203 lbs.	\$629 pair
MP-500R	145	Royal Blue	333 lbs.	\$798 pair
MP-500RG	145	Green	333 lbs.	\$798 pair
MP-500RR	145	Red	333 lbs.	\$798 pair
MP-500RW	145	White	333 lbs.	\$798 pair
MP-500RY	145	Yellow	333 lbs.	\$798 pair
MPC-5145R*	145	Royal Blue	167 lbs.	\$409 each
MP-521R	220	Royal Blue	487 lbs.	\$998 pair
MP-521RR	220	Red	487 lbs.	\$998 pair
MPC-5211R*	220	Royal Blue	244 lbs.	\$509 each

* Center poles allow for a 2 court setup



Game Standard Base Color Choices:



IMPORTANT SAFETY NOTICE

Game standards are heavy pieces of gymnasium equipment and require proper set-up, handling and maintenance by trained supervisory personnel only.



EXCLUSIVE "SAFETY HUB"

Jaypro's exclusive "safety hub" allows for easy assembly and prevents unauthorized tampering.

Extra drive pin secures the upright to the hub for an extra margin of safety

Nut is welded to hub so it can not be lost

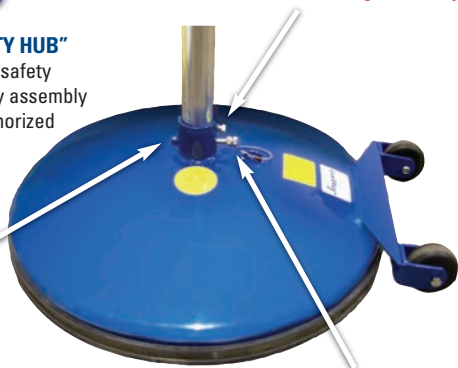

Shown in Royal Blue

Safety bolt is tethered to hub so it cannot be lost.



PBC-24

Base Pad

Fits 24" diameter portable bases. Two piece foam pad is 2" thick and covered with vinyl. Available in Red.

PBC-24 6 lbs. **\$279 each**



For Indoor or Outdoor Use!

JT-175R

Economy Practice Tennis Standards

This pair of 44"H, 2" O.D. galvanized steel standards include two 145 lb. rubber-mounted roll-a-way bases. Suitable for indoor or outdoor use.

JT-175R 314 lbs. **\$779 pair**



Economy Tennis Net

Lightweight construction makes this net ideal for use with our portable standards. Body is a tough #336, 1-1/2" sq. mesh weather-resistant black knotless nylon. 2" wide white vinyl headband with black taped side and bottom edges. Top cable is 1/4" dia. nylon cord. 42'L x 39"H

TDP-42 7 lbs. **\$148 each**



Easy Play Game Standard

Great for volleyball, badminton, tennis, basketball rims and other games!

6-5/8" diameter powder coated steel base includes 6" non marring wheels and is filled with 105 lbs of customer supplied ballast. Two piece 10' H, 2" O.D. galvanized steel upright includes sliding collars for various net heights. Overall size 40" W x 32" D. Net and other accessories sold separately.

EZ-55HP 64 lbs. **\$289 each**

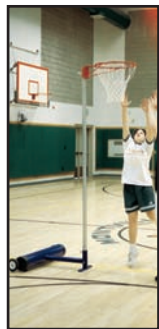

EZNB-10



EZBB-8

Net Ball Adapter

Includes goal, net and mounting hardware. Fits any 2" O.D. game standard upright.

EZNB-10 15 lbs. **\$129 each**

Elementary Basketball Adapter

Includes backboard, goal, net and mounting frame. Fits any 2" O.D. game standard upright. Maximum goal height is 7' for safety. For indoor use only.

EZBB-8 46 lbs. **\$389 each**

Weight never comes off the floor making the EZ-55HP the easiest game standard to move!

See page 113 for Nets.

Easy to tip and roll!

48 HOUR QUICK SHIP



EZ-55HP

SS-320R

Deluxe Game Standards

2-3/8" O.D x 8' H galvanized steel uprights with net tensioning ratchet. 24" dia. steel base includes hand knob and guy wire for firm anchoring and two 4" wheels. Two floor anchors required (available on page 13).

SS-320R 142 lbs. **\$795 pair**

Deluxe Center Standard

(not shown) Single upright used with the SS-320R for a two court set-up. Two floor anchors required (available on page 13).

SSC-321R 75 lbs. **\$495 each**



Floor anchors required. See page 13.

AS-300

T-Base Game Standards

2-3/8" O.D x 8' H galvanized steel uprights with net tensioning ratchet. 2" x 4" T style steel base includes hand knob and guy wire for firm anchoring and two 4" wheels. Two floor anchors required (available on page 13).

AS-300 90 lbs. **\$585 pair**

Center

(not shown) Single upright used with the AS-300 for a two court set-up. H style base requires two floor anchors (available on page 13).

ASC-301 50 lbs. **\$395 each**



Portable Tetherball Pole

This all-time favorite playground activity can now be played indoors or outdoors. The sturdy 10', 2" O.D. galvanized steel upright has a 12" long pre-assembled leader chain. The 24" dia. x 75 lb. steel base has a protective rubber rim and two non-marring wheels for easy roll-a-way port-ability. Ball purchased separately.

TBP-275R 100 lbs. **\$399 each** 

Semi-Permanent Outdoor Tetherball Pole

(Not Shown) A fun-filled game for any outdoor playground set-up. Upright is 2" O.D. galvanized steel and includes an 18" long aluminum ground sleeve with cast aluminum top cap for semi-permanent installation. Installed pole is 8-1/2'H. Ball purchased separately.

TBP-200 18 lbs. **\$169 each** 

Mega-Duty Permanent Tetherball Pole

(Not Shown)

2-3/8" O.D. galvanized steel with cap and leader chain. Ball purchased separately.

TBP-250 38 lbs. **\$199 each** 

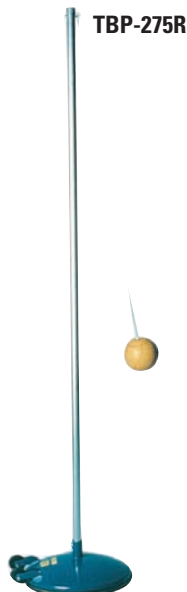

Tetherball
Ultra-cushioned, sponge rubber construction in yellow. Includes recessed rope holder and nylon rope.

TBP-BALL 3 lbs. **\$18 each**

New Generation Little Champ™ - The BEST, now even BETTER!

Great for youth leagues and developing elementary shooting skills.



Easy and safe one person install



SAFETY FEATURE!
Frame does not extend below backboard



Quick & easy height adjustment



Hinged rim folds up and rear frame folds in for compact storage



Fully collapsible with dual wheels for easy transport

Little Champ™ Easy Adjust Backboard Adapter

- Safely attaches to **ANY** goal & backboard. **CAN NOT** be dislodged during play
- Installs in seconds by one person from floor - lightweight aluminum construction
- **QUICK & EASY** height adjustable from floor - 6-1/2' to 8-1/2' - no need to disassemble
- **FOR SAFETY** - No structure ever extends below backboard

- The ultimate in compact storage with hinging rim and folding aluminum frame
- Adjustable frame overcomes sagging rims
- Dual wheels for easy transport
- Moves backboard 2' closer to foul line
- Comes complete with fan shaped backboard, attachment frame and official size goal with nylon net. Comes fully assembled

Little Champ™ Easy Adjust Backboard Adapter (single)

LC-6HP

49 lbs.

\$669 each

Little Champ™ Easy Adjust Backboard Adapter (pair)

LC-6

98 lbs.

\$1,269 pair

Little Champ™ 8.5



LC-2



Safe and easy to install, no damage to the rim!

Little Champ™ 8.5 Backboard Adapter

Converts existing backboard to youth regulation height of 8'6". Designed to fit on any style rim and rectangular backboard, with or without edge padding. Frame features adjustment hinge to ensure the board is always plumb. Our exclusive hinged rim folds up and the rear frame folds down for storage. Includes fan shaped backboard, attachment frame and official size 5/8" goal with nylon net.

Little Champ™ 8.5 Backboard Adapter (single)

LC-2HP

38 lbs.

\$499 each

Little Champ™ 8.5 Backboard Adapter (pair)

LC-2

76 lbs.

\$989 pair

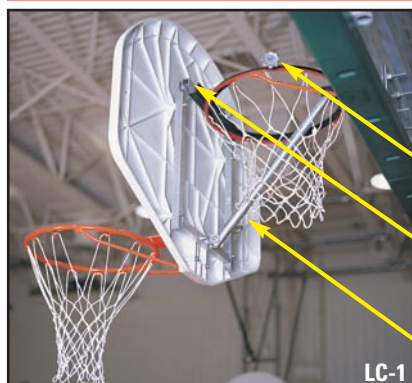

Little Champ™ CLASSIC Backboard Adapter

Quickly converts regulation height courts to official youth goal height of 8'6" and brings the goal 2' closer to the foul line. Includes full-sized fan shaped backboard with aluminum backframes and official size 5/8" goals with nylon nets.



Lightweight aluminum frame fits securely in steel channel

Hand knobs easily secure the Little Champ (black ring) to the existing goal

Diagonal support adds strength and rigidity

Little Champ™ CLASSIC Backboard Adapter (single)

LC-1HP

46 lbs.

\$449 each

Little Champ™ CLASSIC Backboard Adapter (pair)

LC-1

92 lbs.

\$849 pair

FSGB-1 Replacement Backboard

20 lbs.

\$219 each



Deluxe Floor Hockey Goals

The best and most durable hockey goals available. Lightweight 1-5/16" O.D. galvanized steel with mounted rubber feet to protect gym floor. Tough, polyethylene nets are 1-3/4" mesh and have a colorful sleeve-type binding (one red, one blue). 4'H x 6'W x 20"D.

FHGN-33

67 lbs.

\$794 pair

Replacement Nets

Replacement nets for FHGN-33 are 1-3/4" square mesh and constructed of extra durable, twisted polyester. Nets have a colorful sleeve-type binding (one red, one blue).

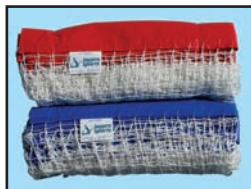

FHN-36

5 lbs.

\$159 pair



FHG-46PR



Non marking wheels transport goal quickly and easily!

Folding Multi-Purpose Goal

Use this convenient goal for quick games in the gym, street or driveway. Rolls easily on non-marking wheels and folds flat for storage. 4'H x 6'W. 1-5/16" O.D. steel frame that includes a durable knotless nylon net with vinyl sleeves (one red, one blue) with hook-and-loop closure.

FHG-46PR

Goals

78 lbs.

\$398 pair

FHG-46N

Red Net

5 lbs.

\$79 each

STG-46N

Blue Net

5 lbs.

\$79 each



Archery Target Stand

Steel tube storage stand with powder coated finish. Adjustable for 24"-48" targets. Firmly holds targets in place. Wheeled for easy transport. Color: Silver.

PE-120

10 lbs.

\$74 each



Archery Tripod Target Stand

Steel tube storage stand with powder coated finish. Falls to tripod position for stability. For 24"-48" targets. Firmly holds targets in place. Cushioned footing for indoor/outdoor areas. Color: Silver.

PE-121

10 lbs.

\$54 each



Throw Down Bases

For indoor or outdoor use. Flexible, washable rubber. Set includes three bases, home plate and pitching rubber.

BB-50

2 lbs.

\$16 set



PE-FLXBX

Torso Flexibility Box

Designed to test individuals maximum reach and torso flexibility. Durable steel construction with foot rest plate. Accurately measures in inches and centimeters. Size: 20"L x 12"W x 12"H.

PE-FLXBX

12 lbs.

\$149 each

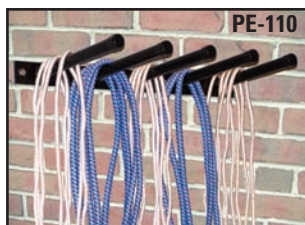

PE-110

Jump Rope Rack

Keep your jump ropes untangled and ready for use. Wall mounted all steel construction. Features five 10" long pegs for storage. Powder coated finish. 27" long.

PE-110

5 lbs.

\$45 each



Cone Cart

Durable 1" dia. steel powder coated blue frame. Includes large 8" dia. wheels for use indoor and outdoors. Rubber stopper protects gym floors. Will hold up to 130 standard 12" cones.

CNCART

3 lbs.

\$159 each



CNCART



Experience The "Tennis Club" Look! Deluxe Internal Wind Club Tennis Posts in Round or Square

Deluxe Internal Wind Club Tennis Posts

Offers the "Tennis Club" look and durability of institutional posts. 11 gauge steel posts include solid stainless steel internal worm gear with self locking mechanism that prevents recoiling during winding and removable handle. Available in 3" round in green or black or 3" square in green. Nets available separately (see page 119). Ground sleeves available for semi-permanent installation.

RTP-300	ROUND - Green	46 lbs.	\$319 pair
RTP-300BK	ROUND - Black	46 lbs.	\$299 pair
STP-200	SQUARE - Green	58 lbs.	\$319 pair

Replacement Winch

RTP-300WH	ROUND Winch & Handle	4 lbs.	\$89 each
STP-200WH	SQUARE Winch & Handle	4 lbs.	\$89 each

Ground Sleeves

STPGS-2	Ground Sleeve for STP-200	24"L	\$99 pair
RTPGS-3	Ground Sleeve for RTP-300	24"L	\$99 pair

Heavy Duty Permanent /Semi Permanent Tennis Posts

3-1/2" O.D. powder coated steel posts include steel top pulley caps with 1-3/4" diameter aluminum pulley. Tensioning ratchet has spring-loaded safety latch and removable handle. Nets and ground sleeves for semi-permanent installation available separately.

TP-125	69 lbs.	\$389 pair
---------------	---------	-------------------

Galvanized Steel Tennis Posts

(Not shown.) Constructed with unpainted galvanized steel post. Includes same net tension device as TP-125.

TPGS-35	68 lbs.	\$389 pair
----------------	---------	-------------------

TP-150G	Ground Sleeve for 3-1/2" semi-permanent use	12 lbs.	\$149 pair
----------------	---	---------	-------------------

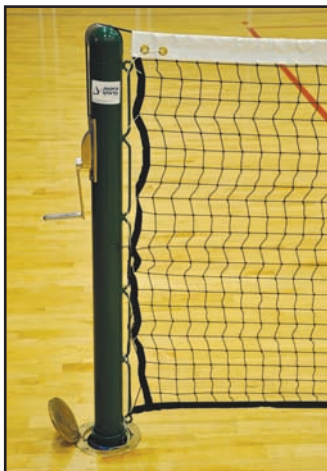

Deluxe Internal Wind Indoor Tennis Posts

Indoor tennis posts with the durability of our institutional series posts. 3" round, 11 gauge steel posts with powder coated green or black finish for excellent durability. Solid stainless steel internal worm gear winch with self locking gear mechanism to prevent re-coil during winding. Removable winch handle for safety. Includes 36' long net. Use in existing 10" deep floor sleeves spaced at standard volleyball distance (36').

ITS-300	Green Posts	46 lbs.	\$489 pair
ITS-300BK	Black Posts	46 lbs.	\$489 pair

PVB-70S	Floor Sleeve & BRASS Hinged Cover for 3" I.D. x 10" deep	22 lbs.	\$419 pair
PVB-70S-CP	Floor Sleeve & CHROME Hinged Cover for 3" I.D. x 10" deep	22 lbs.	\$419 pair



Tournament Deluxe Tennis Net

Constructed of durable **3.5 mm braided** black polyethylene netting. Quadruple stitched heavy-duty polyester web headband with a 3/16" dia. vinyl-coated steel cable. Top five rows are double mesh. Includes synthetic-taped bottom edges and grommeted side pockets with dowels. 42'L x 42"H

Best Seller!

48 HOUR QUICK SHIP

TTN-3

21 lbs.

\$229 each

Collegiate Model Tennis Net

Constructed of 2.5 mm twisted black polyethylene netting. Quadruple-stitched heavy-duty double thickness headband with a 1/8" dia. vinyl coated steel cable. Top five rows are double mesh. Black synthetic-taped side and bottom edges. 42'L x 42"H

48 HOUR QUICK SHIP

TPL-5

18 lbs.

\$169 each

Country Club Pro Tennis Net

Constructed of heavy-duty 3.6 mm braided polyethylene body, 38 oz. reinforced vinyl headband. Heavy duty vinyl coated side and bottom tapes, side pockets with metal dowels. 42'L x 42"H

CCPTN42

20 lbs.

\$199 each



Economy Tennis Net

Lightweight construction makes this net ideal for use with our portable standards. Body is a tough #336, 1-1/2" sq. mesh weather-resistant black knotless nylon. 2" wide white vinyl headband with black taped side and bottom edges. Top cable is 1/4" dia. nylon cord. 42'L x 42"H

48 HOUR QUICK SHIP

TDP-42

7 lbs.

\$148 each

Tennis Net

To be used with volleyball systems. 36'L x 42"H

TPV-13

6 lbs.

\$189 each



4' Court Side Tennis Bench

10" wide non-skid aluminum powder coated green planks and 2" x 2" heavy duty galvanized steel legs for superior rust resistance. Same high quality as our full line of player benches!

PB40PC

50 lbs.

\$329 each



RolDri® Sponge Roller

This 36" wide seamless Tennis Court Roller is made from tough, durable polyvinyl alcohol. The non-deteriorating foam is molded directly onto the roller core for a seamless fit to ensure rapid, streak less drying.

TCSR

Entire Roller

8 lbs.

\$74 each

TCSR-RR

Roller Only

2 lbs.

\$42 each



Heavy Duty Ratchet Reel for TP-125

Sturdy construction with removable handle and safety latch to prevent fly-away. Fits existing posts. Ratchet painted green. Tough, long-lasting galvanized steel handle.

RT-5PC

4 lbs.

\$72 each



Tennis Post Top Cap for TP-125

Fits 3-1/2" O.D. posts. Steel powder coated green. 1-3/4" pulley sheave and set screws.

CAP-35

2 lbs.

\$22 each

Center Strap

2" wide adjustable nylon webbing with double snap hook.

CS-1

1 lb.

\$12 each

Center Strap Anchor

All-aluminum construction with stainless steel drive pin for easy snap assembly.

A-2

1 lb.

\$38 each

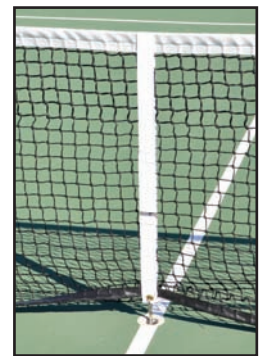

Classic Wind Screen

An attractive yet economical wind screen that will meet all of your privacy, wind and background needs. Open mesh 8.2 oz/sq yd PVC coated polyester provides up to 84% shade. Includes reinforced hems and rust resistant grommets spaced at 18" intervals. **3 Year Warranty.** Refer to page 58 for colors and details. **Customize your windscreen.** Does not ship from Jaypro's CT warehouse. Call for freight quote.

TWS-6 6' height

\$0.69 sq. ft.

TWS-9 9' height

\$0.72 sq. ft.

Armor Mesh Windscreen

14 oz. woven, extrusion vinyl coated polyester mesh available 6' or 9'H. Fabricated with IncrediSeal™ heat sealed hem providing a clean look and eliminating the risk of stitches or seams coming undone! Provides 75% shade. Wind vents and cable ties sold separately. Colors shown on page 58. Does not ship from Jaypro's CT warehouse. Call for freight quote.

WSCRN-6 6' height

\$0.89 sq. ft.

WSCRN-9 9' height

\$0.99 sq. ft.



WSCRN-9

Product	Page	Product	Page
A		Product	Page
Aerosol Paint	69	Scoreboards	70, 80
Agility Training	34, 44	Scorer's Tables	63, 94, 107
Archery Stands	117	Shooting Stations	88
Artificial Turf	55	Shoulder Pad Storage	42
B		Side Fold Backstops	87
Backboard Adapters	116	Sideline Seating	35, 94
Backboard Edge Padding	81	Sideline Markers	42
Backboards	78-80	Soccer Goal Anchors	31-32
Backstop Padding	51	Soccer Goal Net Attachments	32
Badminton System	9	Soccer Goal Pads	32
Ball Bags	32	Soccer Goal Wheel Kits	20, 22-25
Ball Racks	15, 109-110	Soccer Goals - Club	24-25
Ball Storage	15, 32, 63, 108-111	Soccer Goals - Official	19-23
Base Accessories	62	Soccer Goals- Youth	26-28
Base Plugs	62	Soccer Nets	30
Baseball Backstops	51	Soccer Rebounders	29
Baseball Bases	60	Soccer Shelter	35
Basketball Nets	83	Soccer Training Tools	34
Basketball Posts - Outdoor	72-77	Soccer/Football Combo Goals	36-37
Basketball Rims	82-83	Soft Toss Screens	53
Basketball Winches	88	Speed Training	34
Bat Rack	62	Sports Training Machines	71
Batters Box Template	64	Stationary Backstops	86
Batting Cages	48-50	Storage Carts	11, 15, 42, 108-110
Batting Mats	55	T	
Batting Tees	62	Team Benches	35, 102-103
Batting Tunnel Frames - Indoor	56	Tennis Accessories	119
Batting Tunnel Frames - Outdoor	54-55	Tennis Nets	119
Batting Tunnel Nets	54, 56	Tennis Posts	118
Bike Racks	95	Tetherball	115
Bleacher Enclosure Kit	105	Tip & Roll Bleachers	100-101
Bleacher Transport Kit	103	Totemasters™	108-109
Bleachers	100-105	V	
C		Volleyball Antennae	11
Chinning Bar	95	Volleyball Equipment Carriers	15
Combination Goals	36-37	Volleyball Floor Anchors	13
Cones	33	Volleyball Floor Sleeves	12
Corner Flags	33	Volleyball Nets	10
D		Volleyball Net Keepers	11
Discus Cage	99	Volleyball Referee Stands	14
Divider Curtains	85	Volleyball Standard Pads	13
Drag Mats	64	Volleyball System Accessories	13
Dry Line Markers	67	Volleyball System Packages	4-5
Edge Padding	77	Volleyball Systems - Indoor	6-9
F		Volleyball Systems - Outdoor	17
Fence Top Protection	66	Volleyball Training Aids	16
Field Covers	57	Volleyball Winches	13
Field Hockey Goals	45	W	
Field Hockey Nets	45	Wall Ladders	95
Field I.D. Markers	33, 47	Wall Mounted Backstops	86-88
Field Maintenance	64-65	Wall Pads	93
		Windscreen	57, 119
		Wrestling Mat Storage System	85
Product	Page		
Field Markers	67, 69		
Field Marking Dust	68		
Field Marking Packages	68		
Field Marking System	68		
Field Netting	21, 40, 47, 97-99		
Field Rakes	65		
Field Wall Padding	51		
Fielder's Screens	52-53		
Floor Hockey Goals	117		
Floor Hockey Nets	117		
Fold Up Backstops	87		
Football Field Accessories	43-44		
Football Goal Ground Sleeves	38, 41		
Football Goal Post Pads	41		
Football Goals - Official	37-40		
Football Goals - Practice	37		
Football Hinge Kit	41		
Football Storage Equipment	42		
Football Training	42-44		
Foul Poles	58-59		
G			
Game Standards	114-115		
germinija™	111		
Gym Floor Protection	94		
GymGlide™	112-113		
H			
Height Adjusters	89		
Home Plates	60-61		
Hoop Rejuvenator™	74		
K			
Kicking Cages	44		
L			
Lacrosse Goals	46-47		
Lacrosse Nets	46		
Lineman Chutes	43		
Little Champ™ Basketball Adapters	116		
M			
Mound Covers	57		
O			
Outfield Distance Markers	58		
P			
Physical Education	112-117		
Pitching Machines	63		
Pitching Mounds	63		
Pitching Rubbers	61		
Pitching Screens	52-53		
Player Seating	35, 94		
Players Benches	35, 106-107		
Portable Basketball Units	90-92		
Post Protector Pads	41, 75		
R			
Rail Padding	66		
Rugby Goal	37		
S			
Safety Straps	85, 88		
Sand Bags	31		





CUSTOMER INFORMATION AND TERMS & CONDITIONS

Contact Us:



Ph: 800-243-0533
860-447-3001



Email: info@jaypro.com



On-line: www.jaypro.com



Fax: 800-988-3363
860-444-1779



Mail: 976 Hartford Tpke
Waterford, CT 06385

How do I place an order?

Schools and municipalities are required to fax, email or mail a purchase order to receive Net 30 terms. Prepaid orders can be placed with a credit card over the phone, on our website or can be mailed in with a check. Confirmations will be sent via email only upon request.

How will my order ship?

All small parcels ship via UPS or FedEx. Items marked with the truck icon  will ship via common carrier. A contact name and phone number are required for carrier convenience. Deliveries to a non-commercial address carry an additional fee. Commercial addresses have a receiving dock/area and have someone present to offload and sign for deliveries during normal business hours. Drivers delivering truck shipments are only required to move freight to the edge of their truck. Truck accessorial options (inside delivery, 24 hour notification, lift gates, etc.) carry additional charges. All deliveries are FOB Waterford, CT or manufacturer. Refused shipments will incur charges for both directions of travel and are subject to a 20% restocking fee. Original freight will not be reimbursed. Express delivery may be available for small parcels. Please contact Customer Service for details.

When will I receive my order?

Jaypro is committed to shipping orders for all stock items within 48 hours. Once your order leaves our facility, transit times will vary from 1-6 business days depending on your location. Out of stock or custom items, and items shipped from separate locations may have extended lead-times.

Quotes

Quote requests may be faxed, mailed, or emailed at any time. Jaypro will return a written quote including a quote number and expiration date. When ordering, a copy of the quote or the quote number must be referenced for the pricing to be honored. All verbal quotes (pricing and freight) are estimates only. Jaypro is not responsible for honoring verbal estimates as pricing and freight costs are subject to change without notice.

Prices

Prices are subject to change without notice. Prices are in US dollars. Jaypro is not responsible for international exchange rates.

Discrepancies & Returns

All discrepancies must be reported within 30 days of the ship date. Jaypro is not responsible for any claims after 30 days. We reserve the right to replace, repair or refund as appropriate.

Returns

Jaypro will accept the authorized return of all standard products for any reason within 30 days of the ship date. SPECIAL ORDER/ CUSTOM COLOR ITEMS ARE NOT RETURNABLE. Customers must obtain a return authorization number from Jaypro after supplying the invoice number, item number, and reason for return. Please contact Jaypro prior to making any returns as unauthorized returns may not be accepted. Customer is responsible for a 20% restocking fee and return freight charges. Original freight charges will not be reimbursed. All returned merchandise must be in its original packaging and must include the return authorization number on the label.

Freight Damages & Discrepancies

Damages or shortages must be reported within 30 days of the ship date. It is the responsibility of the customer to sign the delivery receipt as damaged or short. Jaypro is allowed by the carrier 30 days from the delivery date to file a claim on shipments with noted damage or shortages and 10 days on concealed damage. If Jaypro is notified within this time

frame, we will replace as needed and file the claim with the carrier. If we are notified after this time frame, it is the responsibility of the customer to secure settlement with the carrier and to purchase replacements.

Payment Terms

We accept checks, American Express, Discover, MasterCard, and Visa. Approved schools and municipalities are required to submit a purchase order and will be billed Net 30 from the invoice date. In our efforts to go paperless, invoices will only be emailed, therefore an email address must be provided on the purchase order. We encourage customers to make ACH payments whenever possible. Please contact our accounting department for required set-up information. All past due accounts are subject to a 1.5% per month (18% per year) interest charge and collection costs. Any approved account choosing to pay by credit card after the invoice date may be subject to a 3% credit card processing fee. Returned checks will result in processing fees added to customer accounts and may result in suspension of credit privileges. The check writer is also responsible for all other check recovery costs (\$35 fee), including attorneys' fees, court costs, and taxes.

Tax

Connecticut residents are subject to 6.35% sales tax and New Jersey residents are subject to 7% sales tax unless a copy of the tax exempt form or resale certificate is provided. Tax exemption is only applicable if the purchase and payment are made by the exempt organization. Personal purchases for the organization are not tax exempt.

Warranty & Product Information

Limited Warranty: Jaypro warrants most of our products against defects in workmanship and material for three years from the date of shipment, unless otherwise noted in the catalog. Nets are warranted for one year. Warranties on other manufacturer's products shown in our catalog may vary and are subject to change without notice. Normal deterioration of products due to weather, wear and tear or other causes that do not affect the functional use are not covered by the warranty. In no case do we warrant any product's safe and useful life to be greater than twelve years. Alteration or modification of the product voids any warranty. Jaypro reserves the right to repair, replace, or refund as appropriate. Please contact Jaypro for instructions and return authorization. This limited warranty is exclusive and in lieu of all other warranties, expresses or implied, including warranties of merchantability and fitness for a particular purpose. Jaypro shall not be liable for any incidental or consequential damages of any nature whatsoever. This warranty gives you specific legal rights, and may have other rights, which vary from state to state.

Product Redesign

Jaypro reserves the right to redesign or change material of products shown in this catalog in order to improve safety, durability, or value.

Warning

All sporting activities carry the risk of injury to the participants. Improperly maintained equipment and inadequately supervised programs are significant contributing factors. All equipment must be thoroughly inspected and maintained to reduce risk to the users.

Thank You

We appreciate your business. Whether you are a returning customer, or if it is your first experience with us, we will do whatever we can within reason to ensure your complete satisfaction. Please contact our Customer Service Department should you have any questions about our products, policies, or services.

We reserve the right to correct typographical errors.

MS2015A

PRESORTED STD
U.S. Postage Paid
Bolingbrook, IL
Permit No. 648



Jaypro Sports LLC
976 Hartford Turnpike
Waterford, CT 06385

Contact your local Jaypro Dealer
or Jaypro at:

Phone: (Toll Free) 800-243-0533
860-447-3001

Fax: (Toll Free) 800-988-3363
860-444-1779

Jaypro Sports LLC © 2015

The Quality and Value You Expect From Jaypro! • www.jaypro.com

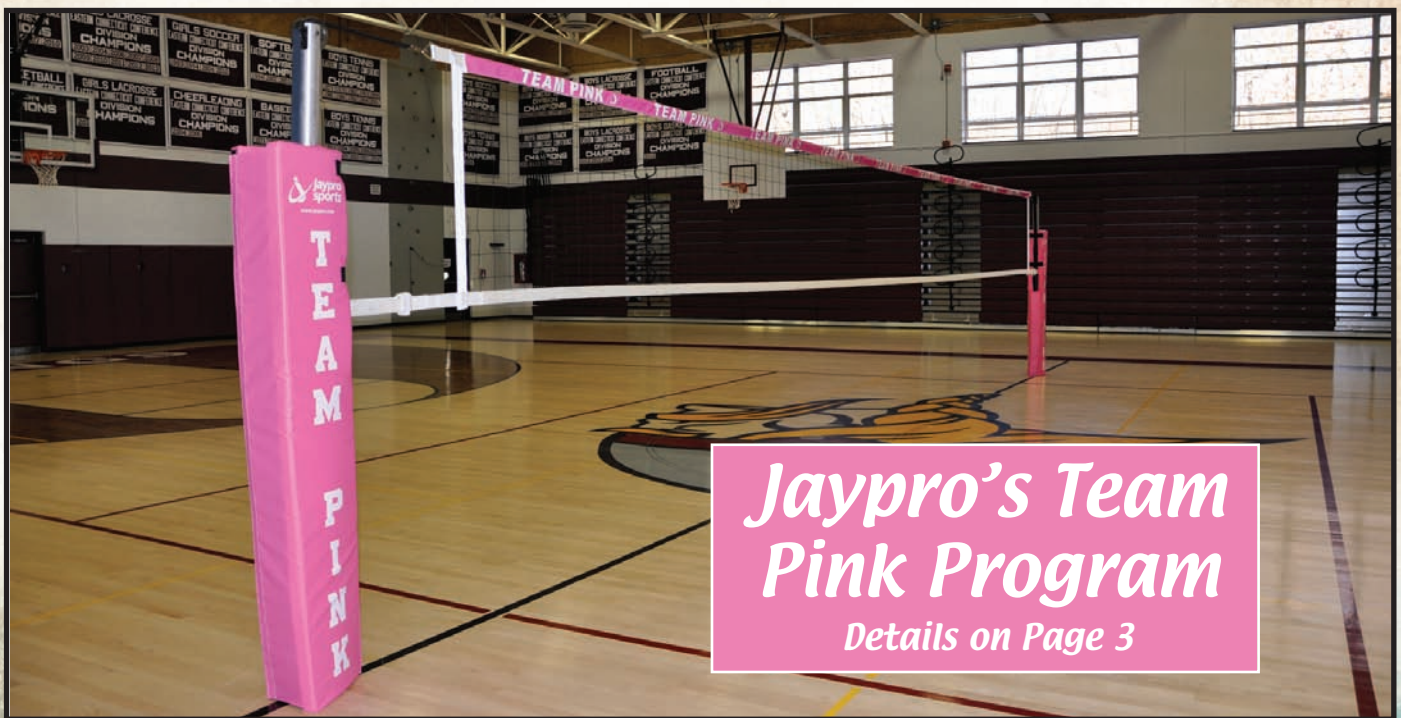

Jaypro's Team
Pink Program

Details on Page 3

Join us on facebook

fb.com/JayproSportsLLC

Follow us on
twitter

@JayproSports

Contact your local Jaypro Representative or Jaypro today!

Benches & Bleachers • Portable Backstops • Field Maintenance & Protection • Foul Poles • Official & Club Soccer Goals
Youth Training/Practice Goals • Soccer Training Aids • Football Goal Posts • Combo Goals • Volleyball Net Systems
Referee Stands • Game Standards • Lacrosse & Field Hockey Goals • Outdoor & Indoor Basketball Systems
Backboards, Rims & Nets • Storage Carts • Ball Carriers • Tennis Posts & Nets • Windscreens • Bike Racks • Wall Pads

Call Jaypro Toll Free: 800-243-0533