



SPALDING
TRUE TO THE GAME®

BASKETBALL | GYMNASIUM | VOLLEYBALL



spaldingequipment.com | 1-800-435-3865

2015 EQUIPMENT



OFFICIAL BACKSTOP SUPPLIER TO:

National Basketball Association



Women's National Basketball Association



NBA® Development League



2015 NBA® All-Star Game™



OFFICIAL SUPPLIER OF BACKSTOP, BACKBOARD, AND GOAL TO:

National Collegiate Athletic Association®



2015 NCAA® Men's Final Four™



2015 NCAA® Women's Final Four™



LEVEL OF PLAY ICONS for basketball



FOR Professional PLAY



FOR Collegiate PLAY



FOR High School PLAY



FOR Recreational PLAY

About Spalding® Equipment

In 2004, Russell Brands, LLC acquired American Athletic, Inc. ("AAI"), located in Jefferson, Iowa, and consolidated its Spalding® equipment, namely basketball systems, volleyball systems and gymnasium equipment, under one roof, alongside AAI's gymnastic and cheer equipment products. In this way, the famous Spalding® brand of equipment was paired with AAI's 60 years of equipment manufacturing expertise and now both brands are leaders in their respective industries:

- Spalding is the world's largest basketball equipment brand.
- Spalding is the official backstop of the NBA® and the NCAA®, including the NCAA® Final Four™
- AAI is the world's leading manufacturer of gymnastics apparatus in all categories.
- AAI is the official equipment supplier to USA Gymnastics® and the NCAA®.

1876



A.G. Spalding & Bro. is established by Hall of Fame pitcher Albert G. Spalding in Chicago, Illinois

1894



A.G. Spalding develops the first basketball

1895



A.G. Spalding manufactures the first American volleyball

1954

American Athletic, Inc. is established in Jefferson, Iowa manufacturing recreational and competitive trampolines



1961



American Athletic, Inc. adds gymnastic apparatus, protective mats, and volleyball products to their offerings

1980

American Athletic, Inc. broadens its volleyball equipment line

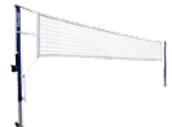

1996



American Athletic, Inc. merges with Basketball Products International from Everett, WA

1999

University of Hawaii selects American Athletic, Inc. for the 1999 Women's NCAA® Volleyball Championship in Honolulu, Hawaii

2004



Russell Brands, LLC acquires athletic equipment manufacturer American Athletic, Inc.

2003

Russell Brands, LLC acquires leading ball producer Spalding



2006

Spalding becomes the official basketball equipment supplier to the National Collegiate Athletic Association®



2008



Spalding becomes the official backboard for the NBA Development League®

2009

Spalding becomes the official backstop of the National Basketball Association®



2010



Spalding becomes the official basketball system for the Women's National Basketball Association®



[BASKETBALL]

- 03** | Positive Lock Breakaway Goals
- 04** | Flex Breakaway Goals
- 05** | Fixed Goals
- 06 – 09** | Glass Backboards
- 10** | Nets and Goal & Board Mounting Diagrams
- 11** | Backboard Packages
- 12** | Non-Glass Backboards
- 13 – 14** | Outdoor Basketball Poles
- 15 – 22** | Portable Backstops
- 23** | Scorers Tables
- 23 – 24** | Training Aids
- 25** | Ball Trucks

[GYMNASIUM]

- 26 – 27** | Protective Wall Padding
- 28** | Wall-Braced Backstops
- 29** | Spalding® Helix™ Height Adjuster
- 30 – 31** | Ceiling-Suspended Backstops
- 32 – 33** | Divider Curtains
- 34** | Batting Cages
- 35** | Gymnasium Components
- 36** | Gymnasium Controllers
- 37** | GymPro™

[VOLLEYBALL]

- 38 – 39** | Freestanding System
- 40 – 41** | Lite Steel Systems
- 42 – 45** | Elite Aluminum & Steel Systems
- 46 – 47** | Slide Multi-Sport System
- 48** | Telescoping Multi-Sport Systems
- 49** | Tennis & Badminton Systems
- 50** | Floor Plates and Sleeves
- 51** | T-Bases & Floor Anchors
- 52 – 53** | Volleyball Nets & Accessories
- 54** | Volleyball Upright Padding
- 55** | Volleyball Referee Platforms & Pads
- 56 – 57** | Volleyball Accessories
- 58** | Volleyball Court Layouts
- 59** | Connect With Us

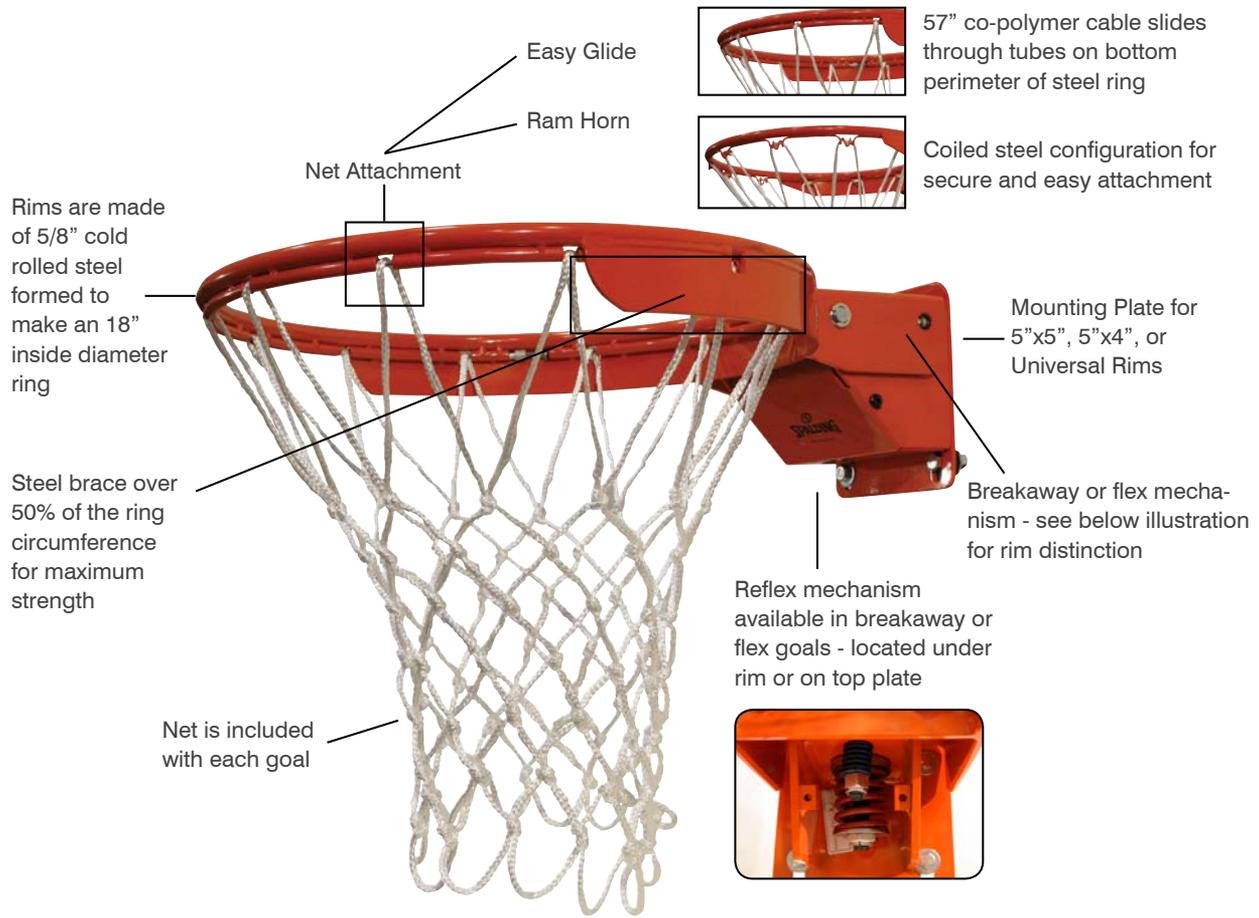

GOAL DISTINCTION



POSITIVE LOCK BREAKAWAY GOALS - Positive Lock goals are spring loaded to withstand a specific amount of force applied to the rim before they automatically release and pivot downward. The amount of force required to release the goal is adjustable. Once the force is removed, the rim will return to play position.



FLEX BREAKAWAY GOALS - Flex breakaway goals are spring loaded but do not include the positive lock mechanism, therefore there is no force threshold required to move the rim. Increasing the force load will cause the rim to travel farther away from play position. Once the force is released, the rim will automatically return to play position.



FIXED GOALS - Fixed goals are made of a hard-wearing steel that will not flex or breakaway, but stay strong through repetitive use.



ARENA® 180 GOAL

- High performance goal with 180-degree positive lock break away action for professional and collegiate play
- Factory calibrated breakaway meets NBA® rebound elasticity requirements
- Compatible with main court portables only
- Padded cover plate with upper and lower finger guard made of dense foam & rubber to prevent pinching
- Sound reducing padded cover plate
- Anti-whip net and mounting hardware included
- Seven-year warranty

413-583 Arena® 180 Goal w/5" x 4" Mounting Pattern



EASY GLIDE NET SYSTEM



Official goal of the NBA®

SLAM-DUNK® GOAL

- High performance positive lock breakaway goal for collegiate play
- Factory calibrated breakaway meets the highest level of rebound elasticity requirements
- Universal mounting pattern is compatible with 48" and 42" backboards
- Anti-whip net and mounting hardware included
- Seven-year warranty

411-704 Slam-Dunk® Pro Goal w/Universal Mounting Pattern (Easy Glide #2 net system)

411-705 Slam-Dunk® Goal w/Universal Mounting Pattern (Ram Horn net system)



EASY GLIDE NET SYSTEM



411-705

RAM HORN NET SYSTEM

SLAMMER COMPETITOR GOAL &

- Performance positive lock breakaway goal for high school and recreational play
- Universal mounting pattern is compatible with 48" and 42" backboards
- Standard net and mounting hardware included
- Two-year warranty

411-508 Slammer Competitor Goal w/Universal Mounting Pattern (Ram Horn net system)

411-528 Slammer Competitor Goal w/Universal Mounting Pattern (Easy Glide #2 net system)



EASY GLIDE NET SYSTEM



411-508

RAM HORN NET SYSTEM



 EASY GLIDE NET SYSTEM



Official goal of the 2015 NCAA® Men's & Women's Final Four™

SLAM-DUNK® PRECISION 180 GOAL

- Official goal of the 2015 Men's and Women's Final Four™
- High performance goal with 180-degree flex breakaway action for collegiate play
- Adjustable reflex mechanism maintains NCAA® rebound elasticity requirements
- **Now uses standard easy glide cable to wrap full circumference of the rim**
- Meets NCAA® & NFHS specifications
- Anti-whip net and mounting hardware included
- Seven-year warranty

413-577 Slam-Dunk® Precision 180 Goal w/5" x 5" Mounting Pattern
413-574 Slam-Dunk® Precision 180sb Goal w/5" x 4" Mounting Pattern



 EASY GLIDE NET SYSTEM

SLAMMER COMPETITION 180 GOAL &

- Performance goal with 180-degree flex breakaway action for recreational play
- Meets NFHS Specifications
- Universal mounting pattern is compatible with 48" and 42" backboards
- Anti-whip net and mounting hardware included
- Two-year warranty

411-723 Slammer Competition 180 Goal w/Universal Mounting Pattern



 RAM HORN NET SYSTEM

SLAMMER FLEX GOAL

- Flex breakaway goal for recreational play
- Continuous ram horn net system
- Universal mounting pattern is compatible with 48" and 42" backboards
- Standard net and mounting hardware included
- One-year warranty

411-506 Slammer Flex Goal w/Universal Mounting Pattern

- All Spalding® goals are electrostatically powder coated orange
- Flex Breakaway Goals not intended for outdoor use

ROUGHNECK GORILLA GOAL &

- Fixed goal for aggressive play
- 5/8" diameter support arm for superior strength
- T-Tie net attachments for forceful impacts
- Universal mounting pattern is compatible with 48" and 42" backboards
- Nylon net and mounting hardware included
- Limited lifetime warranty

411-556 Roughneck Gorilla Goal w/Universal Mounting Pattern

411-557 Roughneck Gorilla Goal II w/Universal Mounting Pattern

- Same features as the Roughneck, but with a double ring configuration



T-Tie NET SYSTEM

411-557 ROUGHNECK GORILLA GOAL II

SUPER GOAL &

- Fixed goal for playground use
- 5/8" diameter support arm for superior strength
- Continuous ram horn net system
- Universal mounting pattern is compatible with 48" and 42" backboards
- Nylon net and mounting hardware included
- One-year warranty

411-551 Super Goal w/Universal Mounting Pattern

411-553 Super Goal II w/Universal Mounting Pattern

- Same features as the Super Goal, but with a double ring configuration



RAM HORN NET SYSTEM

411-553 SUPER GOAL II

HERCULES® &

- Rear mount fixed goal for recreational play
- Fits most rear mount boards
- Continuous ram horn net system
- Universal mounting pattern is compatible with 48" and 42" backboards
- Nylon net and mounting hardware included
- Two-year warranty

411-554 Hercules® w/Universal Mounting Pattern

411-552 Hercules® II w/Universal Mounting Pattern

- Same features as the Hercules, but with a double ring configuration



RAM HORN NET SYSTEM

411-552 HERCULES® II

- Fixed goals are recommended for indoor/outdoor use
- Goals are electrostatically powder coated orange
- See page 10 for mounting diagrams



FEATURES

5/16" ALUMINUM FRAME FITTED WITH SHOCK ABSORBING MATERIAL TO THE GLASS

FOUR 3/16" THICK KEY HOLE BRACKETS IN THE CORNERS FOR MOUNTING

1/2" TEMPERED GLASS

2" BORDER AND TARGET ARE FIRED INTO THE GLASS FOR LIFETIME LASTING FINISH

MOUNTING PLATE TO ATTACH GOAL - See board for specific mounting pattern

SPALDING

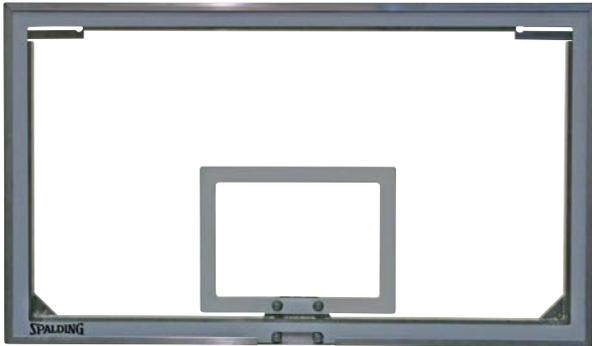

Official Backboard of the NBA®

ARENA® BACKBOARD

- Direct goal mount designed to prevent the goal from touching the glass
- **Only** compatible with main court portable backstops
- Meets all FIBA, NCAA®, and NFHS specifications
- Full perimeter strongback
- Limited Lifetime warranty (outdoor use is not covered)
- Goal mounting pattern: 5" x 4"

N413-002 Arena® Backboard 72" x 42"

3" FULL PERIMETER STRONGBACK

The Arena® Backboard (N413-002) comes standard with a full perimeter strongback. This 3" channel stiffens the backboard.



Official Backboard of the 2015 NCAA® Men's and Women's Final Four™

SUPERGLASS™ BACKBOARD FOR MAIN COURT PORTABLES

- Direct goal mount designed to prevent the goal from touching the glass
- **Only** compatible with main court portable backstops
- Meets all FIBA, NCAA®, and NFHS specifications
- Standard perimeter strongback
- Limited Lifetime warranty (outdoor use is not covered)

413-002 SuperGlass™ Backboard 72" x 42"

3" STANDARD PERIMETER STRONGBACK

The SuperGlass™ Backboard comes standard with strongback. This 3" channel stiffens the backboard.

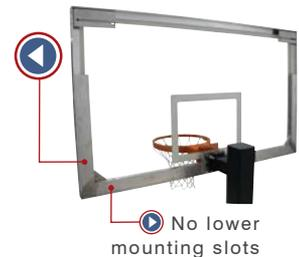

SUPERGLASS™ PRO BACKBOARD

- Regulation glass backboard for professional, collegiate and international competition
- Direct goal mount designed to prevent the goal from touching the glass
- Compatible with Wall-Braced and Ceiling-Suspended
- Standard Perimeter Strongback
- Meets all FIBA, NCAA®, and NFHS specifications
- Limited Lifetime warranty (outdoor use is not covered)
- Goal mounting patterns: 5" x 4" (413-001), 5" x 5" (413-000)
- 413-000 Backboard mounting pattern: 42 1/2" x 63"
- 413-001 Backboard mounting pattern: 36 1/2" x 63"

413-000 SuperGlass™ Pro Backboard 72" x 48"

413-001 SuperGlass™ Prosb Backboard 72" x 42"

See page 10 for mounting diagrams



3" STANDARD PERIMETER STRONGBACK

The SuperGlass™ Pro Backboard comes standard with strongback. This 3" channel stiffens the backboard.

*E-Z Bolt padding not included with backboards but recommended



SuperGlass™ Collegiate Backboard with Center Strut 72" x 42"



SuperGlass™ Collegiatesb Backboard 72" x 42"

SUPERGLASS™ COLLEGIATESB BACKBOARD WITH CENTER STRUT &

- Regulation glass backboard for collegiate and high school competition
- Compatible with most existing wall mount and ceiling mount structures
- Four corner mount with center strut rim support
- Meets NCAA® and NFHS specifications
- Goal mounting pattern: 5" x 4"
- Backboard mounting pattern: 36" x 63"
- Twenty year warranty; outdoor use is not covered

413-011 SuperGlass™ Collegiatesb with center strut 72" x 42"

SUPERGLASS™ COLLEGIATE BACKBOARD &

- Regulation glass backboard for collegiate and high school competition
- Compatible with single mast ceiling suspended units
- Compatible with Helix™ Height Adjuster
- Mounting bracket purchase may be required
- Meets NCAA® and NFHS specifications
- Lifetime warranty for direct mount; outdoor use is not covered
- Goal mounting pattern: 411-007 - 5" x 4"
411-008 - 5" x 5"
- Backboard mounting pattern: 411-007 - 36" x 63"
411-008 - 42" x 68"

411-007 SuperGlass™ Collegiatesb Backboard 72" x 42"

411-008 SuperGlass™ Collegiate Backboard 72" x 48"

SUPERGLASS™ CONVERSIONSB BACKBOARD &

- High performance glass backboard for collegiate and high school play
- Meets NFHS Specifications
- Built-in adapter frame for upgrading from Fan Shaped to Rectangular Glass Backboard
- Compatible with Helix™ Height Adjuster
- Goal mounting pattern: 5" x 4"
- Backboard mounting pattern: 35" x 20"
- Pre-drilled aluminum frame for bolt-on backboard padding
- Twenty-year warranty

413-019 SuperGlass™ Conversion**s** Backboard 72" x 42"





BANTAM BACKBOARD

- Smaller backboard for practice and recreational play, forcing players to focus on target area
- Includes rim restrainer
- Goal mounting pattern: 5" x 5"
- Backboard mounting pattern: 44 1/2" x 36"
- E-Z Bolt padding not compatible
- Ten-year warranty

413-030 Bantam Backboard 54" x 42"

E-Z BOLT PADDING FOR 72" RECTANGULAR BACKBOARDS



- Bolt-on backboard padding for 72" rectangular backboards
- Constructed of molded urethane with 2 1/4" wide channel
- Meets NBA®, NCAA®, FIBA and NFHS specifications
- Eight bolts for easy attachment to 72" glass backboards
- Sold as a set that will fit on one 72" glass backboard
- Five-year warranty
- 12 color options available

COLORS	GOLD 413-413	ORANGE 413-412	RED 413-411	KELLY GREEN 413-415
	FOREST GREEN 413-416	LIGHT BLUE 413-417	ROYAL BLUE 413-418	NAVY BLUE 413-419
	PURPLE 413-420	MAROON 413-410	GRAY 413-414	BLACK 413-421



Note: Colors shown in catalog and on website may not be an exact match.

IS YOUR GYMNASIUM EQUIPMENT UP-TO-DATE?
 CONTACT YOUR LOCAL CERTIFIED GYMPRO™ DEALER TO SCHEDULE AN INSPECTION.
 MORE INFORMATION ON PAGE 37.





SPALDING® NETS



ARENA® ANTI-WHIP NET

- One-year warranty

413-625 Arena® Anti-Whip Net - 7 oz. Heavy-Duty Nylon Net



PINK ANTI-WHIP NET

- One-year warranty

421-328 Pink Anti-Whip - 7 oz. Heavy-Duty Nylon Net



SUPER NET

- One-year warranty

413-609 Super Net - 9 oz. Heavy-Duty Nylon Net



STANDARD NET

- One-year warranty

413-605 Standard Nylon Net - 5.6 oz.

GOAL MOUNTING PATTERNS

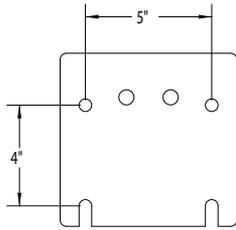

S411-583 Arena® 180 Goal

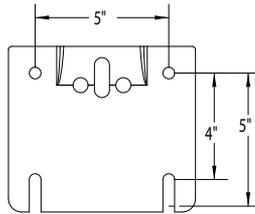

411-704 Slam-Dunk® Pro Goal
411-705 Slam-Dunk® Goal
411-723 Slammer Competition 180 Goal

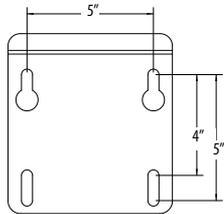

411-508 Slammer Competitor Goal
411-528 Slammer Competitor Goal
411-506 Slammer Flex Goal
411-507 Slammer Flex Goal II

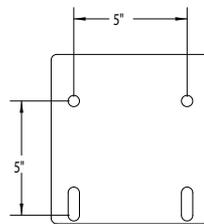

411-577 Slam-Dunk® Precision 180 Goal

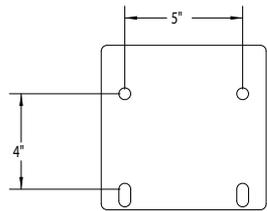

411-574 Slam-Dunk® Precision 180sb Goal

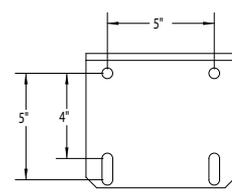

411-556 Roughneck Gorilla Goal
411-557 Roughneck Gorilla Goal II

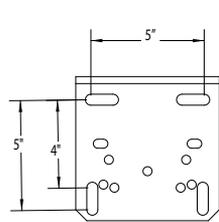

411-551 Super Goal
411-553 Super Goal II

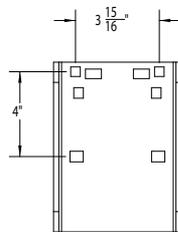

411-554 Hercules®
411-552 Hercules® II

BACKBOARD MOUNTING PATTERNS

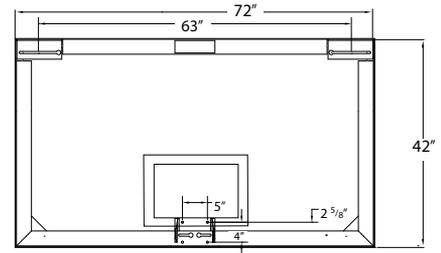

N413-002 Arena® Backboard 72" x 42"

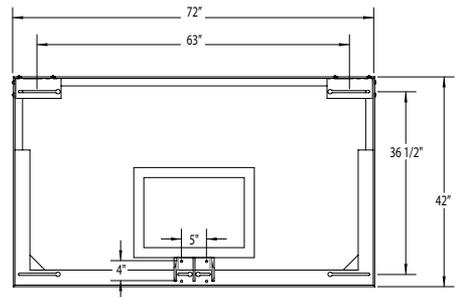

413-001 SuperGlass™ Prosb Backboard 72" x 42"

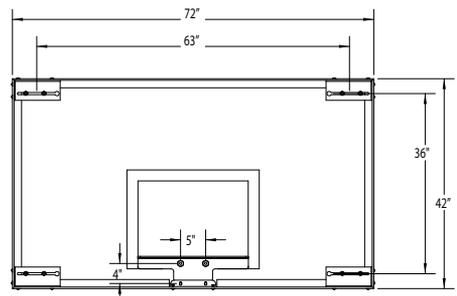

411-007 SuperGlass™ Collegiatesb Backboard 72" x 42"

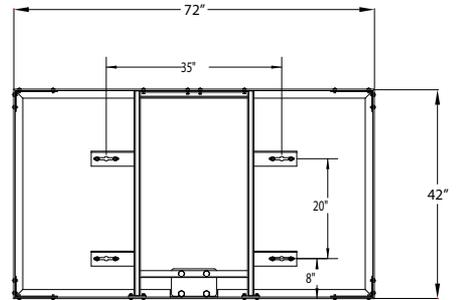

413-019 SuperGlass™ Conversionsb Backboard 72" x 42"



BUILD IT: CHOOSE YOUR BACKBOARD, GOAL & PADDING

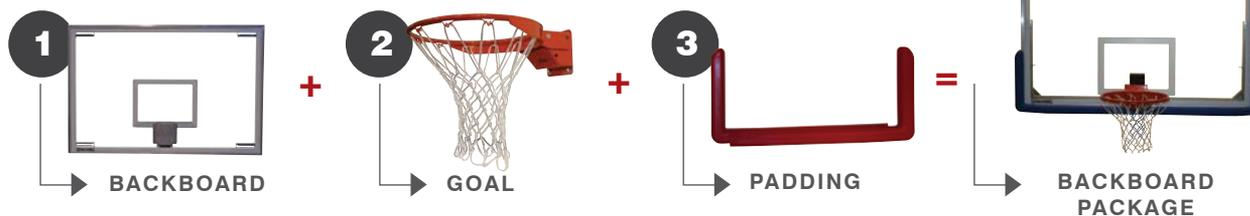

1. CHOOSE YOUR BACKBOARD



- **413-000** SuperGlass™ Pro Backboard 72" x 48"
- **413-001** SuperGlass™ Prosb Backboard 72" x 42"



- **413-011** SuperGlass™ Collegiatesb with center strut Backboard 72" x 42"



- **411-008** SuperGlass™ Collegiate Backboard 72" x 48"
- **411-007** SuperGlass™ Collegiatesb Backboard 72" x 42"

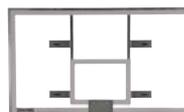

- **413-019** SuperGlass™ Conversionsb Backboard 72" x 42"

2. CHOOSE YOUR GOAL



- **411-704** Slam-Dunk® Pro Goal w/ Universal Mounting Pattern
- **411-705** Slam-Dunk® Goal w/ Universal Mounting Pattern



- **413-577** Slam-Dunk® Precision 180 Goal - not compatible w/42" boards
- **413-574** Slam-Dunk® Precision 180sb - not compatible w/48" boards



- **411-508** Slammer Competitor - Ram Horn w/ Universal Mounting Pattern
- **411-528** Slammer Competitor Goal - Tube Tie w/ Universal Mounting Pattern



- **411-723** Slammer Competition 180 Goal w/ Universal Mounting Pattern

3. CHOOSE YOUR PADDING

- 12 color options available
- Bolt-on backboard padding for 72" rectangular backboards



COLORS	GOLD 413-413	ORANGE 413-412	RED 413-411	KELLY GREEN 413-415
	FOREST GREEN 413-416	LIGHT BLUE 413-417	ROYAL BLUE 413-418	NAVY BLUE 413-419
	PURPLE 413-420	MAROON 413-410	GRAY 413-414	BLACK 413-421

Note: Colors shown in catalog and on website may not be an exact match.



**STEELSB
BACKBOARD**
72" x 42"

STEEL BACKBOARD

- Regulation-size steel backboard for indoor/outdoor play
- White electrostatic powder coated with graffiti resistant finish
- Backboard mounting pattern: 63" x 36"
- Goal mounting pattern: 5" x 4"
- One-year warranty; Lifetime warranty on direct mounts

413-062 Steelsb Backboard 72" x 42"



**STEEL FRONT MOUNT
FAN BACKBOARD**
54" x 39"

STEEL FRONT MOUNT FAN BACKBOARD

- Regulation-size steel fan backboard for indoor/outdoor play
- Reinforced with horizontal channels designed for vibration-free action
- Vertical strongback that strengthens the critical rim area
- Specially designed bolt keeper system allows for easy installation
- Recommended for direct mount with gooseneck poles
- Backboard mounting pattern: 35" x 20"
- Goal mounting pattern: 5" x 5"
- One-year warranty; Lifetime warranty on direct mounts

413-208 Steel Front Mount Fan Backboard 54" x 39" w/orange target



**FIBERGLASSSB
BACKBOARD**
72" x 42"

FIBERGLASS BACKBOARD

- Regulation-size fiberglass backboard for indoor/outdoor play
- 1 1/8" thick high density thermally fused panel
- Three layers of fiberglass on the face and two layers on the back
- Hand laminated for added strength
- Gel Coat sealant provides a moisture-resistant barrier
- Backboard mounting pattern: 63" x 36"
- Goal mounting pattern: 5" x 4"
- Ten-year warranty: outdoor; Lifetime warranty on direct mounts for indoor use

413-051 Fiberglasssb Backboard 72" x 42"



**FIBERGLASS
FAN BACKBOARD**
54" x 39"

FIBERGLASS FAN BACKBOARD

- Backboard mounting pattern: 31 1/2" top / 37" bottom x 20"
- Goal mounting pattern: 5" x 5"
- One-year warranty; Lifetime warranty on direct mounts

413-230 Fiberglass Fan Backboard 54" x 39"





GOOSENECK POLE

- Galvanized gooseneck poles available in 3 1/2", 4 1/2", or 5 9/16" O.D.
- Available in 3', 4', 5', and 6' extensions
- Lifetime warranty
- Sleeve not included - order separately for non-permanent installation

402-801 3 1/2" O.D. Pole with 3' extension

- 402-815 sleeve for 402-801

402-800 4 1/2" O.D. Pole with 4' extension

- 402-816 sleeve for 402-800

402-822 4 1/2" O.D. Pole with 5' extension

- 402-816 sleeve for 402-822

402-835 5 9/16" O.D. Pole with 6' extension

- 402-837 Sleeve for 402-835

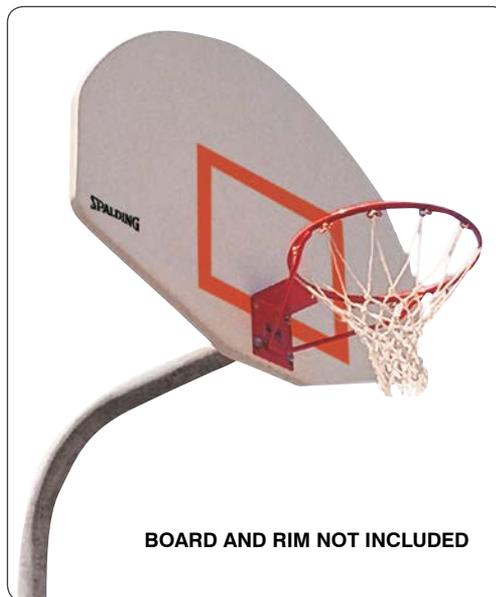

BOARD AND RIM NOT INCLUDED

	402-801 Outdoor Pole 3 1/2" O.D. 3' Ext.	402-800 Outdoor Pole 4 1/2" O.D. 4' Ext.	402-822 Outdoor Pole 4 1/2" O.D. 5' Ext.	402-835 Outdoor Pole 5 9/16" O.D. 6' Ext.
BACKBOARDS				
413-051 - Fiberglass s Backboard	No	No	No	No
413-062 - Steels s Backboard	No	No	No	No
413-208 - Steel Front Mount Fan w/ Target	Yes	Yes	Yes	Yes
413-230 - Fiberglass Fan	Yes	Yes	Yes	Yes
413-222 - Aluminum Fan Powder Coated w/ Target	Yes	Yes	Yes	Yes
GOALS				
411-556 - Roughneck Gorilla Goal	Yes	Yes	Yes	Yes
411-557 - Roughneck Gorilla Goal II	Yes	Yes	Yes	Yes
411-551 - Super Goal	Yes	Yes	Yes	Yes
411-553 - Super Goal II	Yes	Yes	Yes	Yes
SLEEVES				
402-815 - In-Ground Sleeve (3 1/2" O.D.)	Yes	No	No	No
402-816 - In-Ground Sleeve (4 1/2" O.D.)	No	Yes	No	No
402-837 - In-Ground Sleeve (5 9/16" O.D.)	No	No	No	Yes

* Galvanized gooseneck pole

* Systems are listed in price list

* Limited lifetime warranty



Board & Rim
Not Included

DOMINATOR POLE

- Pole is 6" square
- 4' of run-out room from backboard to pole
- Black powder coated finish
- Limited lifetime warranty
- Sleeve not included - Order separately for non-permanent installation

402-797 Dominator Pole

402-820 Sleeve for Dominator Pole



Board & Rim
Not Included

ENFORCER POLE

- 6 5/8" O.D. galvanized steel pole
- 6' of run-out room from backboard to pole
- Limited lifetime warranty
- Sleeve not included - Order separately for non-permanent installation

402-807 Enforcer Pole

402-824 Sleeve for Enforcer Pole

	402-797 Dominator Outdoor Pole	402-807 Enforcer Outdoor Pole
BACKBOARDS	6" Square Tube. - 4' Ext.	6 5/8" O.D. - 6' Ext.
413-051 - Fiberglass Backboard	Yes	Yes
413-062 - Steel Backboard	Yes	Yes
413-230 - Fiberglass Fan	No	No
413-222 - Aluminum Fan Powder Coated w/ Target	No	No
GOALS		
411-556 - Roughneck Gorilla Goal	Yes	Yes
411-557 - Roughneck Gorilla Goal II	Yes	Yes
411-551 - Super Goal	Yes	Yes
411-553 - Super Goal II	Yes	Yes
SLEEVES		
402-820 - In-Ground Sleeve (Dominator)	Yes	No
402-824 - In-Ground Sleeve (Enforcer)	No	Yes

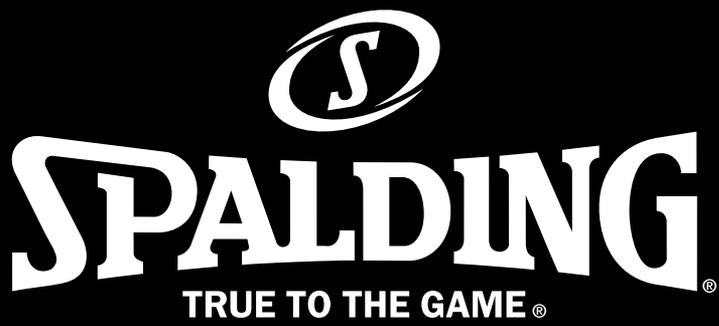

SPALDING

TRUE TO THE GAME®



OFFICIAL BACKSTOP SUPPLIER TO:

National
Basketball
Association



Women's National
Basketball
Association



NBA®
Development
League



2015 NBA®
All-Star
Game™



OFFICIAL SUPPLIER OF BACKSTOP, BACKBOARD, AND GOAL TO:

National
Collegiate
Athletic
Association®



2015 NCAA®
Men's
Final Four™



2015 NCAA®
Women's
Final Four™





DIRECT MOUNT SYSTEM

The hardware buffer system allows the rim to be mounted directly to the backstop frame without the rim bolts touching the glass. This buffer system eliminates the chance of breaking a backboard during play.

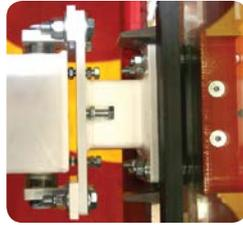

POWDER COATED FINISH

Each Spalding® backstop is powder coated to ensure a durable long-lasting finish. Custom frame colors are available to match your facility's color scheme.



CUSTOM LOGOS

School or sponsor logos can be imprinted on the frame padding of all models of Spalding backstops. Imprinting logos allows you to generate revenue by offering your backstop padding space to local and national sponsors.



FLOOR ANCHOR SYSTEM

A floor anchor system is provided with your backstop to meet the requirements of governing organizations. Whether it is a portable or permanent floor, Spalding has the anchoring system to meet your needs.



AUTOMATIC LIFTING MECHANISM

The ALM system allows Spalding® backstops to be set-up and operated without the use of tools, hydraulics, or sub-frames.



LOCATING SYSTEM

Spalding® backstops employ the best grade of casters, locator pins, and footpads to aid in the simple process of locating your backstop on your court.

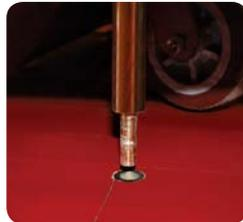

LIFTING MECHANISM

One person can raise and lower the unit in seconds using the spring assisted lifting mechanism and lift assist handles.



SHOT CLOCK HOLDERS

Spalding's ability to custom match holders to precisely fit your shot clocks ensures a solid, vibration-free holder. Whether it's a front, side or top-loading shot clock, two, three or four-sided, Spalding has the capability to fabricate the perfect holder.



INTERNAL WIRING

Shot clock cables and time out indicator wires can all be neatly hidden with the internal wiring option.



OFFICIAL TECHNICAL PARTNER



401-990 Arena® Backstop-Spring Assist with 10' 8" extension

ARENA® BACKSTOP FEATURES:  &  & 

- Available in 10' 8" and 8' extensions to meet all professional, collegiate, high school and international specifications
- Auto Lift Mechanism (ALM) system for one step set-up without tools
- SuperGlass™ Prosb Backboard (42" x 72") with limited lifetime warranty
- Slam-Dunk® Precision 180sb Goal with limited 7-year warranty
- Protective padding covered in 30 oz. vinyl
- Electrostatic powder coated finish available in custom colors
- Rolls on six - 6" x 2" casters for maximum load dispersion
- Counterweight of 1500 to 2000 lbs. for superior stability
- Floor anchor system compatible with all surfaces
- Shot clock holder with wiring and logo pads sold separately
- E-Z Bolt Backboard padding available in 12 color options (see page 9 for colors)

ARENA® BACKSTOP - SPRING ASSIST

- Spring assisted lifting mechanism
- Positive lock at 8', 9' and 10' playing heights

401-990 Arena® Backstop-Spring Assist with 10' 8" extension

401-980 Arena® Backstop-Spring Assist with 8' extension

401-946 Arena® Backstop-Spring Assist with Jack for 10' 8" extension

401-944 Arena® Backstop-Spring Assist with Jack 8' extension

ARENA® BACKSTOP-SPRING ASSIST

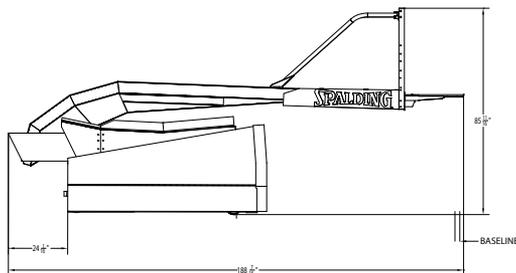

ARENA® BACKSTOP - SPRING ASSIST

storage dimensions: 188 7/16" long x 85 11/16" high x 76" wide

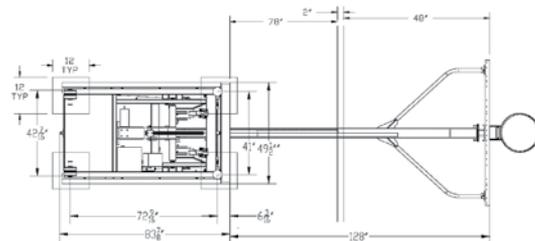

ARENA® BACKSTOP - 10' 8" EXTENSION FOOTPRINT



G8 PORTABLE BACKSTOP

- Main court backstop for high school and intramural competition
- 8' distance from backboard to front pad at standard height
Height adjustable: 6' - 10'
- Spring assisted lifting mechanism
- 3" thick padding covered in 30oz. vinyl
- White powder coated finish (custom colors available)
- 1,000 lbs. of ballast
- Rolls on eight - 6" x 2" urethane wheels for maximum load dispersion
- Shot clock holder with wiring, and logo pads sold separately
- System includes: SuperGlass™ Collegiatesb Backboard (42" x 72"); E-Z Bolt and base padding; floor anchor
- **Warranty:** Backstop and lifting mechanism, 10-year; SuperGlass™ Collegiatesb Backboard, twenty year or lifetime on direct mounts; Slam-Dunk® Precision 180sb Goal, 7-year; Backboard padding, 5-year

401-975 G8 Portable Backstop

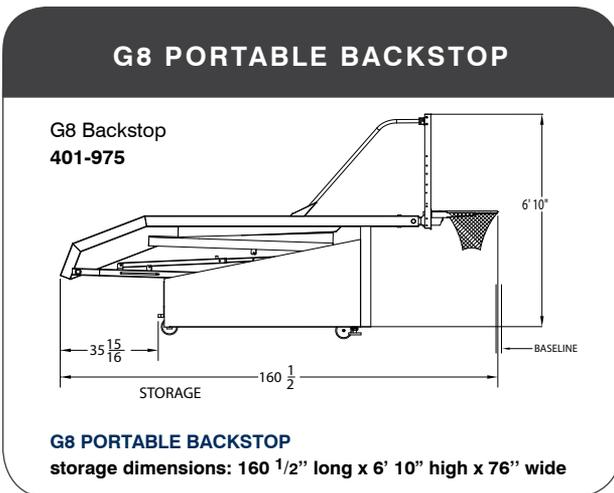

OFFICIAL
TECHNICAL
PARTNER

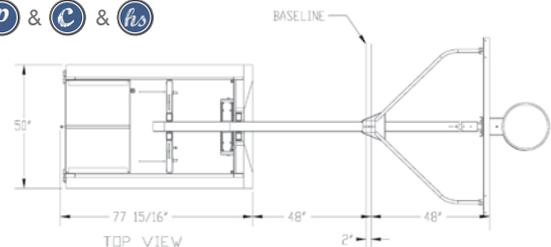

G8 PORTABLE - 8' EXTENSION FOOTPRINT



G5 PORTABLE BACKSTOP

- Side court backstop for college and professional practice
- 5' distance from backboard to front pad at standard height
Height adjustable: 6' - 10'
- Spring assisted lifting mechanism
- 3" thick padding covered in 30oz. vinyl
- White powder coated finish (custom colors available)
- 960 lbs. of ballast
- Rolls on eight - 6" x 2" urethane wheels for maximum load dispersion
- Shot clock holder with wiring, and logo pads sold separately
- System includes: SuperGlass™ Collegiatesb Backboard (42" x 72"); E-Z Bolt and base padding; floor anchor
- **Warranty:** Backstop and lifting mechanism, 10-year; SuperGlass™ Collegiatesb Backboard, twenty year or lifetime on direct mounts; Slam-Dunk® Precision 180sb Goal, 7-year; Backboard padding, 5-year

401-970 G5 Portable Backstop

G5 PORTABLE BACKSTOP

G5 Backstop
401-970

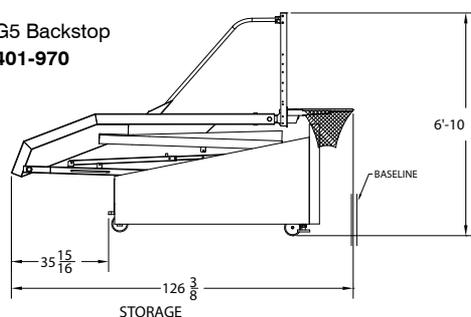

G5 PORTABLE BACKSTOP

storage dimensions: 126 3/8" long x 6' 10" high x 76" wide



OFFICIAL
TECHNICAL
PARTNER

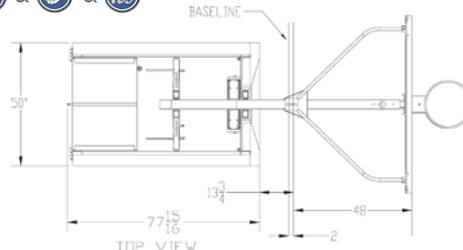

G5 PORTABLE - 5' EXTENSION FOOTPRINT



OFFICIAL
TECHNICAL
PARTNER

2500 PORTABLE BACKSTOP & &

- Portable backstop designed with a smaller base to hold a full-size glass backboard for use at colleges, schools and churches
- 72" x 42" high performance, aluminum framed glass backboard (413-012)
- Backboard is made of 1/2" tempered glass
- Slammer Competitor Goal (411-528)
- Extension arm provides 5' of offset at 10' goal height
- Spring assisted one lever height adjustment (no tools needed)
- Goal height is adjustable from 8' to 10'
- White powder coat finish
- Will fit through standard 6' 8" double door with backboard lowered
- Rolls on four - 4" wheels rated for 600 lbs. each
- Multi-piece base padding included (black only)
- Backstop contains 1,000 lbs. of ballast
- Indoor anchor kit
- **Warranty:** Backstop frame, 10-year; Telescoping brace, 2-year; Floor pedestals, 2-year; Backboard, twenty year or lifetime on direct mounts; Slammer Competitor Goal, 2-year; Backboard Padding, 5-year

401-879 2500 Portable Backstop

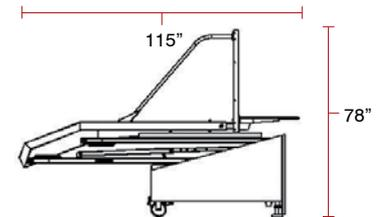
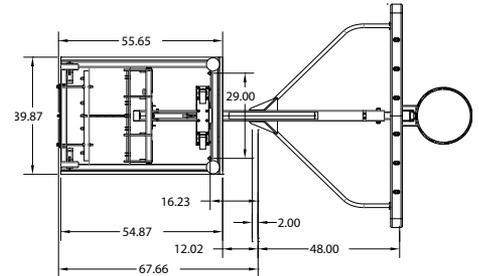

SPALDING® 2500 PORTABLE

storage dimensions: 115" long x 78" high x 72" wide

2000 PORTABLE BACKSTOP & &

- Versatile glass backboard portable basketball system for colleges, schools and churches
- 54" x 42" high performance, aluminum framed glass backboard (411-798)
- Backboard is made of 1/2" tempered glass
- Slammer Competitor Goal (411-528)
- Extension arm provides 5' of offset at 10' goal height
- Spring assisted one lever height adjustment (no tools needed)
- Goal height is adjustable from 7' 6" to 10'
- Will fit through standard 6' 8" double door with backboard lowered
- Rolls on four - 4" wheels rated for 600 lbs. each
- Multi-piece base padding included (black only)
- Backstop contains 725 lbs. of ballast
- **Warranty:** Backstop frame, 10-year; Telescoping brace, 2-year; Floor pedestals, 2-year; Backboard, 10-year; Slammer Competitor Goal, 2-year

411-800 2000 Portable Backstop

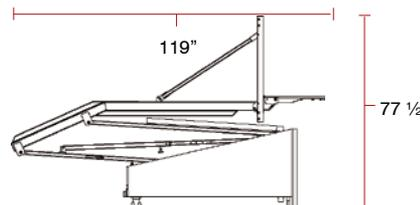
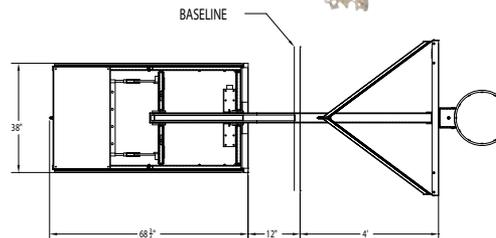
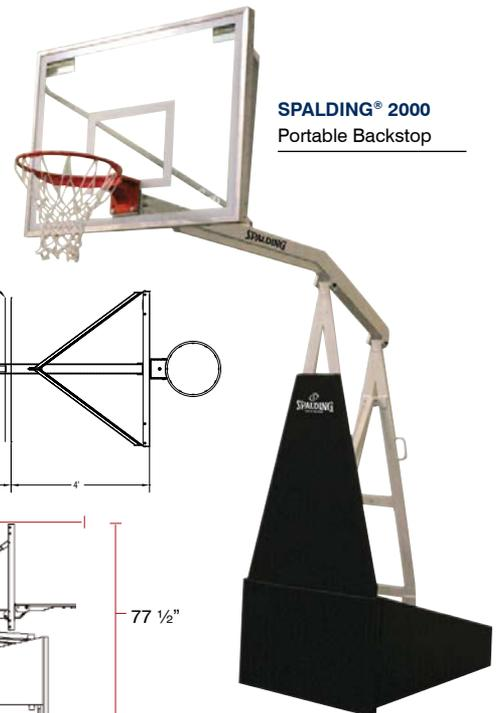

SPALDING® 2000 Portable Backstop

SPALDING® 2000 PORTABLE
storage dimensions: 119" long x 77 1/2" high x 54" wide



411-790



SPALDING® STREET TOURNAMENT
Portable Backstop

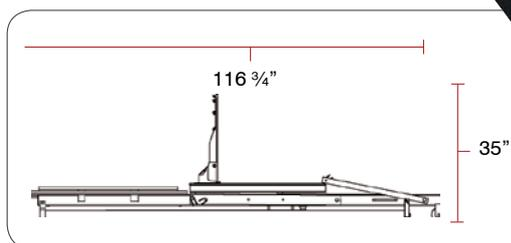

SPALDING® STREET TOURNAMENT
Portable storage dimensions:
116 3/4" long x 35" high x 54" wide

**STREET TOURNAMENT
PORTABLE BACKSTOP**

- Designed for street tournament play
- Extension arm provides 3' of offset at 10' goal height
- 54" x 38" acrylic backboard with steel back framework
- Slammer Flex Goal included (411-506)
- Goal height is adjustable from 8' to 10'
- Backboard folds down for storage
- Base padding included (black)
- **Additional ballast weight required**—
500 recommended lbs. (not included)
- One-year limited warranty

411-790 Street Tournament Portable Backstop

BALLAST
PLATE



411-870



FASTBREAK 960
Portable Backstop

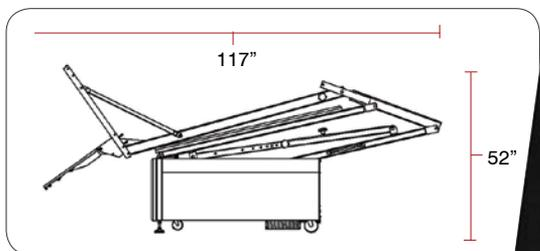

FASTBREAK 960 Portable storage
dimensions: 117" long x 52" high
x 60" wide

FASTBREAK 960 PORTABLE BACKSTOP

- Designed for institutional use at high schools, camps, churches or health clubs
- 60" x 36" high performance, aluminum framed acrylic backboard
- Backboard is 3/8" thick acrylic for superior rebound
- Extension arm provides 6' of offset at 10' goal height
- Pro Image™ Breakaway Goal (411-511)
- Goal height is adjustable from 7' to 10'
- Easily folded by two people
- Multi-piece base padding included (black)
- Base dimensions: 50" x 30" x 21 1/2"
- **Additional ballast weight required** —
300 - 350 lbs. recommended
- Two-year limited warranty

411-870 Fastbreak 960 Portable Backstop



BALLAST STORAGE
COMPARTMENT



FASTBREAK 940 PORTABLE BACKSTOP

- Designed for elementary schools, recreation centers, or as a superior home unit
- 54" x 32" high performance, aluminum framed acrylic backboard
- Backboard is $\frac{3}{8}$ " thick acrylic for superior rebound
- Extension arm provides 6' of offset at 10' goal height
- Pro Image™ Breakaway Goal (411-511)
- Goal height is adjustable from 7' to 10'
- Backboard folds down for storage
- Multi-piece base padding included (black)
- Base dimensions: 50" x 30" x 21½"
- **Additional ballast weight required**— 300 - 350 lbs. recommended
- Two-year limited warranty

411-860 Fastbreak 940 Portable Backstop

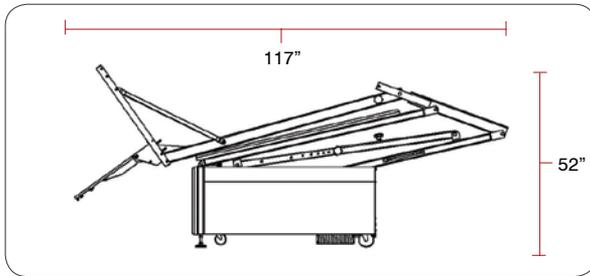

411-860
FASTBREAK 940 Portable
 storage dimensions: 117"
 long x 52" high x 54" wide

FASTBREAK 930 PORTABLE BACKSTOP

- Pole system and backboard tip back for easy movement on built-in wheels
- Quick set up and take down
- Arena Slam® Breakaway Goal
- Acrylic Backboard is 48" x 32"
- Telescoping poles easily adjust goal height from 7' to 10'
- All steel, welded construction
- Base has vinyl trim to avoid marring floors
- Includes full front padding (black)
- **Additional ballast required**—200 recommended lbs. (not included)
- Two-year limited warranty
- Base dimensions: 35 ¼" x 19 ¾" x 13 ¼"

411-835 Fastbreak 930 Portable Backstop w/Acrylic Backboard

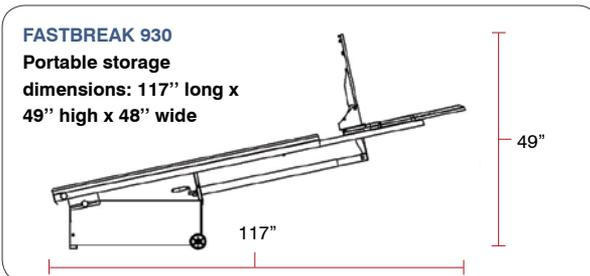

FASTBREAK 930
 Acrylic Backboard
 411-835

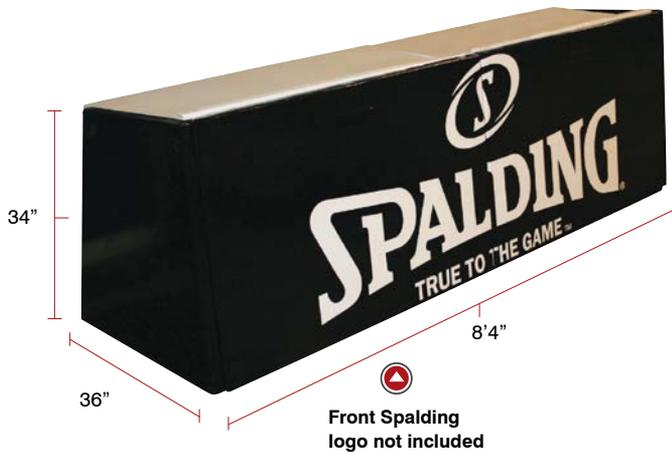

Front Spalding logo not included

PORTABLE SCORER'S TABLE

- Heavy-duty folding table for courtside use
- Accommodates four chairs
- Solid steel welded construction
- Folds quickly for mobility and storage
- Built-in non-marking casters for easy transportation
- Access holes for routing cables
- UL electrical duplex outlet and extension
- Logo and/or school name - one color only for additional fee
- 18 oz. vinyl padding on visible sides (specify color)
- 8'4" x 36" x 34" unfolded for game use, 52" x 21 1/2" x 34" folded for storage
- 245 lbs. shipping weight on pallet, 52" x 36" x 24" shipping size

COLORS	AVAILABLE PADDING COLORS						
	CONTACT SPALDING AT 1-800-435-3865 FOR DETAILS.						
	Red 411-691	Burgundy 411-696	Green 411-694	Navy Blue 411-693	Royal Blue 411-692	Purple 411-695	Black 411-690

NOTE: Colors shown in catalog and on website may not be an exact match. Please request a color swatch.



Spalding logo not included

Custom printed graphics

DIGITAL GRAPHIC SCORER'S TABLE

- Spalding's durable and convenient scorer's tables are now available with custom printed, full color padding
- All digital graphics are done using state-of-the-art, six-color large format printers
- Durable, vivid inks are designed to be long-lasting relative to the silk-screens and vinyl applications of the past
- Our lamination process decreases the likelihood of scratching as well as regular wear-and-tear from daily use
- 8'4" x 36" x 34" unfolded for game use, 52" x 21 1/2" x 34" folded for storage
- 245 lbs. shipping weight on pallet, 52" x 36" x 24" shipping size

Contact Spalding at 1-800-435-3865 for additional information.

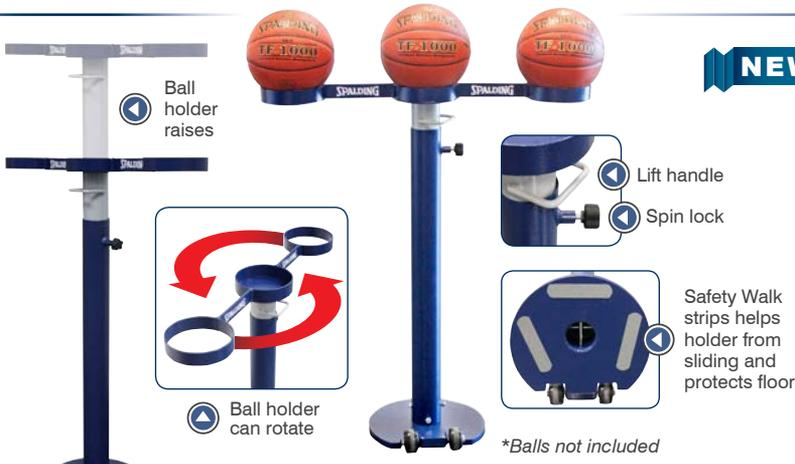

*Balls not included

NEW ARENA® TRAINER

- Arena® Trainer can be used in place of chairs, getting the ball in the player's shooting pocket
- Ball holder can be raised using a lift handle and the height is held with a spin lock
- A thick base helps prevent tipping and safety walk strips on the underside prevents sliding
- Non-marking wheels allow for easy transport when the base is tilted off the floor

411-655 Arena® Trainer





McCALL'S REBOUNDER

- Known as one of the best rebound skill builders on the market
- Sharpens players' rebounding skills
- Ideal tool for increasing grip strength and vertical leap
- Helps improve balance, timing and perception under the goal
- Adjustable from 7' to 12'
- Transports easily on built-in smooth rolling casters

411-621 McCall's Rebounder



WHEELED BOUNCE BACK

- Net frame angles up or down for all types of return passes
- Skid-resistant wheels
- Heavy-duty net and bands
- ³/₁₆" steel, rolling base with easy operating brake
- Net frame is removable in seconds without tools
- Single clamp height adjustment

411-624 Wheeled Bounce Back



FOLDING BOUNCE BACK

- Net frame angles up or down for all types of return passes
- Heavy-duty net and bands
- Folds for compact storage
- Self standing
- Built-in weight tubes eliminate the need for weight bags

411-627 Folding Bounce Back



PRACTICE SHOOTING RING

- Trains shooter to be more accurate on their shots
- Intended to improve athletes concentration and confidence when shooting
- Durable urethane mounts easily attach the shooting ring to the rim without harming it
- Attaches easily to regulation goals reducing target size from 18" to 16"
- Orange powder coat finish
- Three lb. shipping weight

411-610 Practice Shooting Ring



Rim not included



REBOUND RING

- Develops rebounding skills
- Durable urethane mounts easily attach the ring to the rim without harming it
- 11" diameter ring installs easily over regulation goal
- Ball can go through ring, but helps teach position and rebounding
- Orange powder coat finish
- Three lb. shipping weight

411-611 Rebound Ring



Rim not included



Balls not included

NBA® BALL TRUCK

- Holds 18 full size basketballs
- Constructed of steel tubing with grey powder coat finish
- Includes swivel wheels
- Non-topple base
- Angled rails for easy ball removal

411-603 NBA® Ball Truck



Balls not included

REPLICA BALL TRUCK

- Holds 15 full size basketballs
- Constructed of durable chrome steel tubing
- Swivel casters
- Non-topple base
- Angled rails for easy ball removal

411-602 Replica Ball Truck



Balls not included

ECONOMY BALL TRUCK

- Constructed of chrome steel tubing
- Swivel casters
- Non-topple base
- Holds up to 12 balls

411-600 Economy Ball Truck



BALL LOCKER

- Constructed of welded steel
- Non-marring swivel casters
- Lockable
- Holds up to 30 basketballs or 36 volleyballs

411-605 Ball Locker



PUB TABLE

- 30" diameter commercial grade acrylic top with complete beveled edge
- 43" high, powder coated black, steel structure
- Regulation size goal
- Heavy duty white net
- Assembled dimensions 43" x 30" x 30"

421-354 Pub Table



SPORT TABLE

- 24"L x 24"W x 24"H
- 24" Diameter acrylic table top
- Steel post and rim with net set on top of a wood base platform

421-355 Sport Table





DIGITAL GRAPHIC WALL PADS

All digital graphics are printed using state-of-the-art, six-color large format printers. Durable, vivid inks are designed to be long-lasting relative to the silk-screens and vinyl applications of the past. High resolution printing provides sharp image quality from any distance.

CUSTOMIZATION MADE EASY

- Any Spalding® Wall Pad can be custom printed to match your logo and color scheme specifications
- Full color printing allows unlimited color options
- Artwork is printed directly onto vinyl covers and attached to backing material

Please contact Spalding at 1-800-435-3865 for ordering information and specifications on custom digital graphics.



DIGITAL GRAPHIC WALL PADS



WALL MOUNTING ILLUSTRATIONS

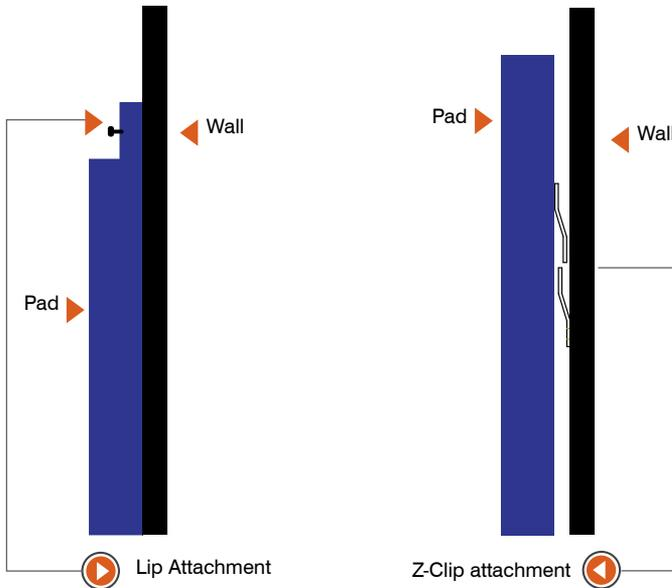

Z-Clip attachment Comes fully assembled on pad

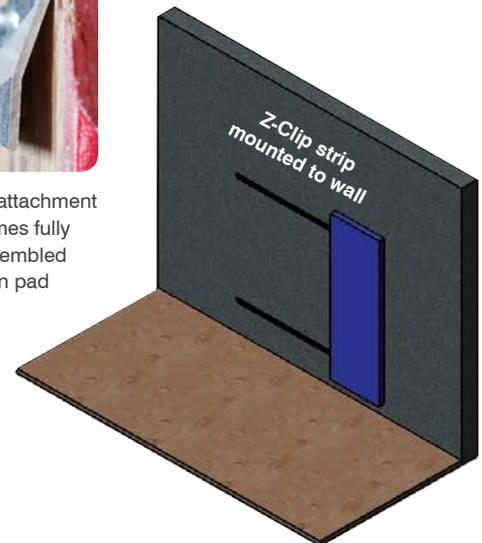

CLASS A FIRE WALL PADS

- 2 7/16" (62mm) thick protective wall padding that can be permanently installed or removable
- Constructed of 7/16" (11mm) O.S.B backing, 2" polychloroprene foam and 18 oz. vinyl cover
- Class A Fire Rating (meets ASTM E84 testing procedures)
- Standard wall pad size is 2' x 6'
- Choose from a variety of standard colors
- Pad meets National Fire Protection Standard 701, ASTM E-84 and CAL 117

Please contact Spalding at 1-800-435-3865 for ordering information.

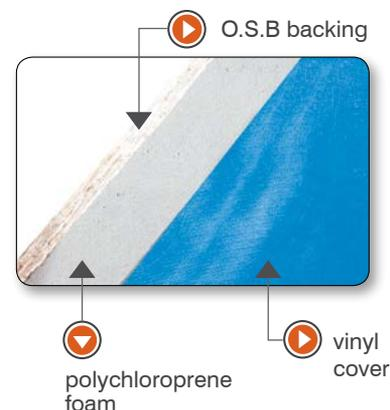

2" POLYURETHANE WALL PADS

- 2 7/16" (62mm) thick protective wall padding that can be permanently installed or removable
- Constructed of 7/16" (11mm) O.S.B backing, 2" 100 ILD polyurethane foam and 18 oz. vinyl cover
- Standard wall pad size is 2' x 6'
- Choose from a variety of standard colors
- Vinyl cover meets National Fire Protection Standard 701, ASTM E-84 and CAL 117

Please contact Spalding at 1-800-435-3865 for ordering information.

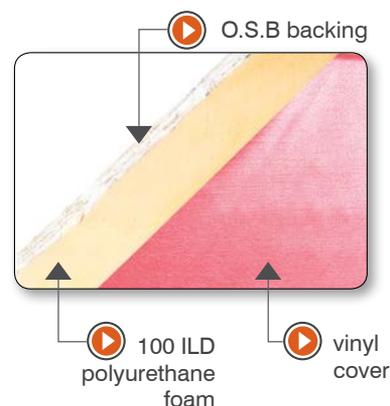

2" LAMINATE

- 2 7/16" (62mm) thick protective wall padding that can be permanently installed or removable
- Constructed of 7/16" (11mm) O.S.B backing, 2" laminated polyethylene foam and 18 oz. vinyl cover
- Standard wall pad size is 2' x 6'
- Choose from a variety of standard colors
- Vinyl cover meets National Fire Protection Standard 701, ASTM E-84 and CAL 117

Please contact Spalding at 1-800-435-3865 for ordering information.

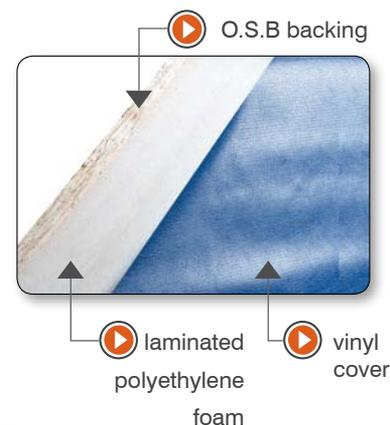

INSTALLATION TIP:

Wall pads should be a minimum of 6' high and installed at a maximum of 6" above the finished floor.



IS YOUR GYMNASIUM EQUIPMENT UP-TO-DATE?

CONTACT YOUR LOCAL CERTIFIED GYMPRO™ DEALER TO SCHEDULE AN INSPECTION. MORE INFORMATION ON PAGE 37.



WALL-BRACED STATIONARY BACKSTOP

WALL-BRACED STATIONARY &

- Available in lengths of 8" to 13' from the wall (extensions more than 1'-6" require 1/4" steel cable – cable included)
- Structure is supported by 1/4" steel cable extending diagonally from the wall to the upper tubing using two cable clamps per attachment
- Four 2" square, steel tube cross braces and extension tubes construct the framework
- Pipe ends have 1/4" heavy-duty flange for attaching to 2" x 6" wall boards and the backboard
- Compatible with all backboards and height adjusters
- Spalding® blue vein powder coat finish (custom colors available)
- Five-year warranty

Please see price list for part numbers.



WALL-BRACED SIDE FOLD BACKSTOP

WALL-BRACED SIDE FOLD &

- Available in lengths of 3' to 13' from the wall (all extension lengths require 1/4" steel cable – cable included)
- Structure is supported by 1/4" steel cable extending diagonally from the wall to the upper tubing using two cable clamps per attachment
- Four 2" square, steel tube cross braces and extension tubes construct the framework
- Telescoping diagonal brace includes locking mechanism and adjustable collar allowing the structure to be precisely placed in playing position from the floor utilizing a factory furnished crank handle
- Off-set steel hinges with 1/4" heavy-duty flanges connect to 2" x 6" wall board and backboard locations to allow the unit to fold flat against the wall
- Compatible with all backboards and height adjusters
- Spalding® blue vein powder coat finish (custom colors available)
- Five-year warranty

Please see price list for part numbers.



WALL-BRACED FOLD-UP BACKSTOP SHOWN WITH HEIGHT ADJUSTER

WALL-BRACED FOLD-UP BACKSTOP &

- Available in lengths of 3' to 13' from the wall (all extension lengths require 1/4" steel cable – cable included)
- Four 2" square, steel tube braces and saddle-welded braces construct the framework
- Steel hinges with 1/4" heavy-duty flanges connect to 2" x 8" wall board and backboard locations
- Structure is supported by 1/4" steel cable extending diagonally from the wall to the upper piping using two cable clamps per attachment
- Backstop is raised by a 1,000lb manual winch (optional electric winch)
- Backstop lifts by a 1/4" steel cable running through a 3-1/2" diameter deep groove cable pulley that is on the upper wallboard
- Compatible with all backboards and height adjusters
- Spalding® blue vein powder coat finish (custom colors available)
- Five-year warranty

Please see price list for part numbers.



SPALDING®'S HELIX™ HEIGHT ADJUSTER HAS SPRING-LOADED TECHNOLOGY WHICH MAKES CHANGING YOUR PLAY HEIGHT A SLAM-DUNK!

SPALDING® HELIX™ HEIGHT ADJUSTER

- Spring-loaded technology for easy height adjustment
- Infinite backboard adjustments between 8-10 feet on Wall-Braced and Ceiling-Suspended Backstops
- Compatible with 72" Rectangular Backboards on Single or Double Mast Backstops
- Constructed of 1½" x 3" structural steel tubing
- Nylon Bushing helps provide smooth movement with the same rigidity of a system without a height adjuster
- Heavy duty spring with PVC coating reduces noise
- Gray powder coated finish
- Includes Crank Handle with Hook
- One-year warranty

313-401 Spalding® Helix™ Height Adjuster - each



*Shown with 411-007 backboard

313-402 Spalding® Helix™ Height Adjuster - pair



SPALDING® HELIX™ FAN HEIGHT ADJUSTER

- Spring-loaded technology for easy height adjustment
- Infinite backboard adjustment between 8-10 feet on Wall-Braced and Ceiling-Suspended Backstops
- Compatible with 20" x 35" mounting pattern for Fan or Conversion Backboards
- Constructed of 1½" x 3" structural steel tubing
- Nylon Bushing helps provide smooth movement with the same rigidity of a system without a height adjuster
- Heavy duty spring with PVC coating reduces noise
- Gray powder coated finish
- Includes Crank Handle with Hook
- One-year warranty

313-403 Spalding® Helix™ Fan Height Adjuster - each



313-404 Spalding® Helix™ Fan Height Adjuster - pair

*Shown with 413-019 backboard



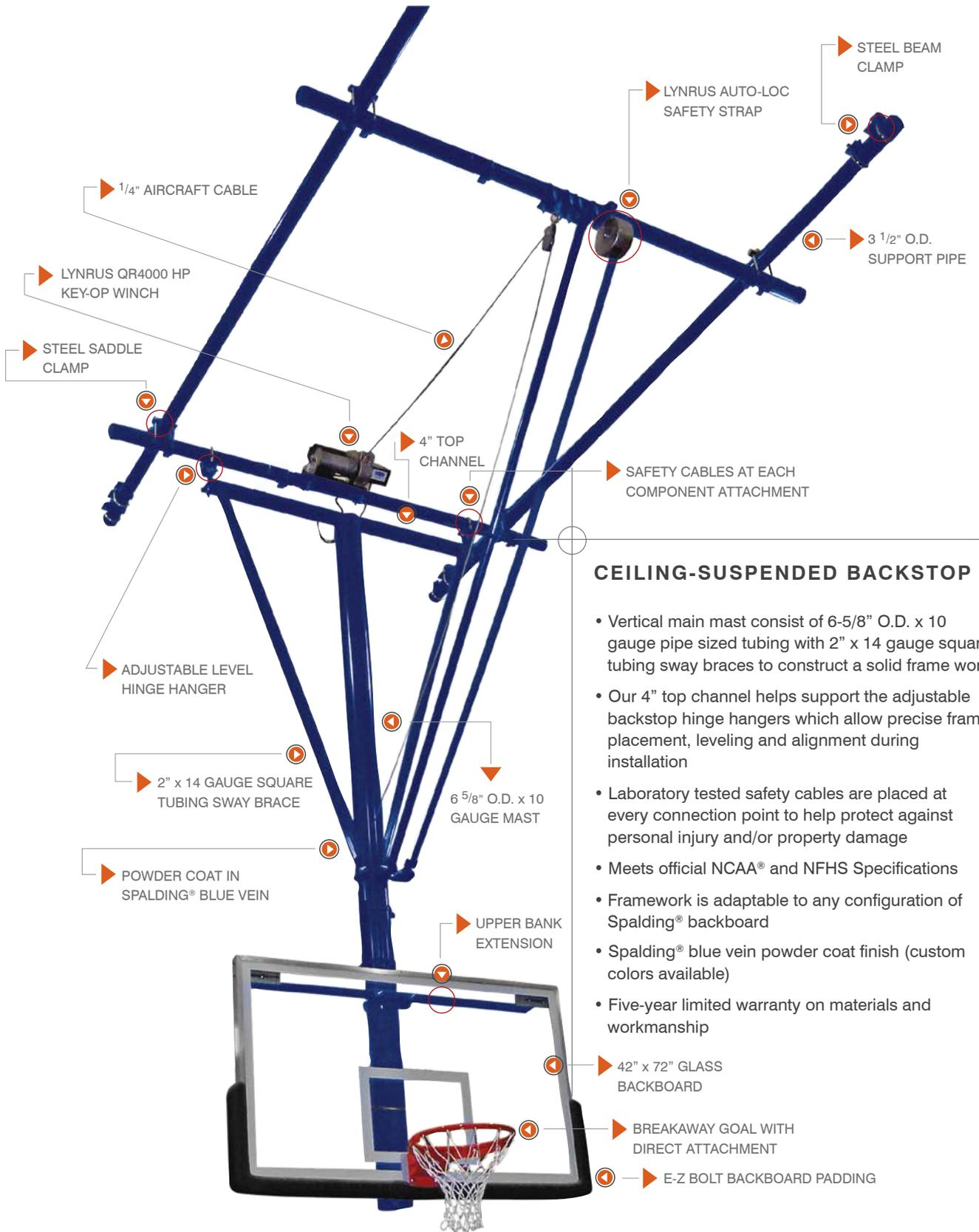

CEILING-SUSPENDED BACKSTOP

- Vertical main mast consist of 6-5/8" O.D. x 10 gauge pipe sized tubing with 2" x 14 gauge square tubing sway braces to construct a solid frame work
- Our 4" top channel helps support the adjustable backstop hinge hangers which allow precise frame placement, leveling and alignment during installation
- Laboratory tested safety cables are placed at every connection point to help protect against personal injury and/or property damage
- Meets official NCAA® and NFHS Specifications
- Framework is adaptable to any configuration of Spalding® backboard
- Spalding® blue vein powder coat finish (custom colors available)
- Five-year limited warranty on materials and workmanship
- 42" x 72" GLASS BACKBOARD
- BREAKAWAY GOAL WITH DIRECT ATTACHMENT
- E-Z BOLT BACKBOARD PADDING



Spalding offers numerous custom configurations of ceiling-suspended backstops to fit your needs. We use only the finest manufactured products to ensure you are getting the best product for your facility. Now all Spalding® mechanized ceiling-suspended backstops shall be supplied with a LynRus Aut-O-Loc 2 safety strap.

All custom painted parts at Spalding are electrostatically powder coated. The powder coat process provides an extremely durable finish and is an environmentally friendly process. Spalding® ceiling-suspended products are all made in the U.S.A and delivered to your facility fully packaged.

Our expert design team can deliver finished products to your facility in as little as two weeks and effectively coordinate all adjacent work including electrical, mechanical and court striping coordination. To complete your project, Spalding certified installers are available and offer a turn-key complete product. To find the right backstop for your facility or for more information on Spalding® products, please visit our website www.spaldingequipment.com or email us at inquire@spaldingequipment.com.

GLIDING REAR-BRACED CEILING MAST

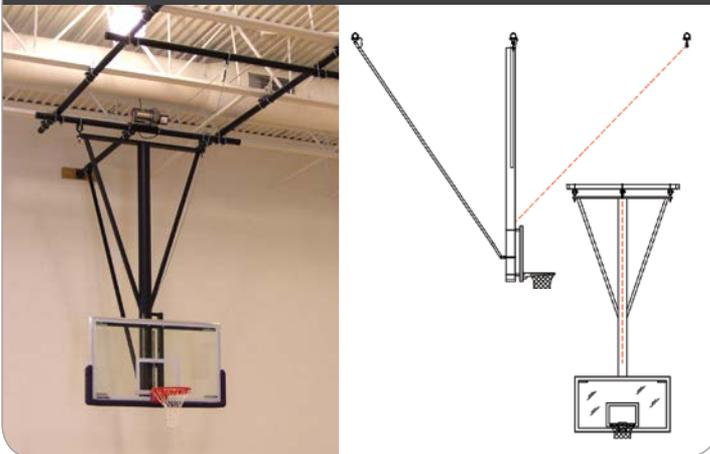

GLIDING REAR-BRACED CEILING MAST

- All bracing hardware is on the rear of the mast for clean game play
- Best ceiling mast for maximum retraction height
- Unit is most stable from 16' attachment height to 40' attachment height
- Can easily be installed as a stationary mount unit
- Smooth forward fold unit

ALL-PURPOSE CEILING MAST

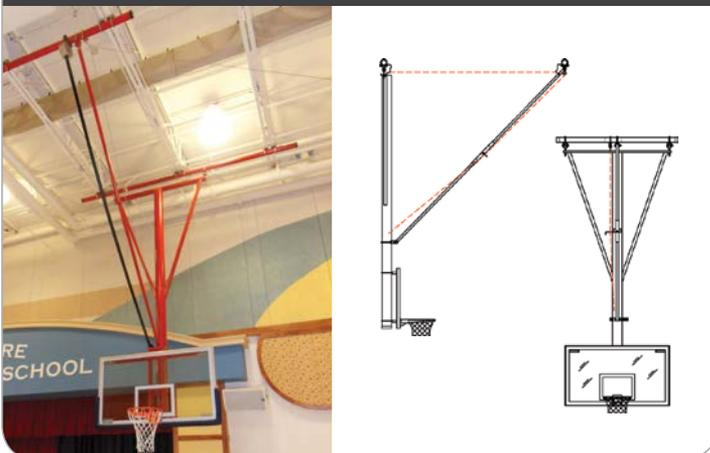

ALL-PURPOSE CEILING MAST

- Unit has a minimal ceiling connection footprint
- Unit with best available space in front, back and side folding options
- Self-locking braces stores in itself in the same direction as the fold

CONTACT SPALDING AT 1-800-435-3865 FOR CUSTOM COLOR OPTIONS.



SAFETY

AT SPALDING, WE ENGINEER EACH CEILING-SUSPENDED BACKSTOP WITH SAFETY AS OUR NUMBER ONE PRIORITY. SAFETY CABLES PROVIDE A COMFORTING BACK-UP TO THE HIGH QUALITY HARDWARE THAT WE PROVIDE.



IS YOUR GYMNASIUM EQUIPMENT UP-TO-DATE?

CONTACT YOUR LOCAL CERTIFIED GYMPRO™ DEALER TO SCHEDULE AN INSPECTION. MORE INFORMATION ON PAGE 37.





Spalding® divider curtains offer facilities a reliable and effective means of maximizing space. They are hand-crafted out of 18oz. reinforced vinyl for privacy and mesh to help with airflow. Our 18oz. vinyl comes in a variety of colors which meet the NFPA 701, ASTM E-84, CAL117, CA Prop 65 and CPSIA compliance. Spalding® divider curtains are custom made for each installation so it is essential to consult your Spalding dealer in order to provide proper dimensions, fabric selections and other features to ensure all the components are included for an appropriate installation.

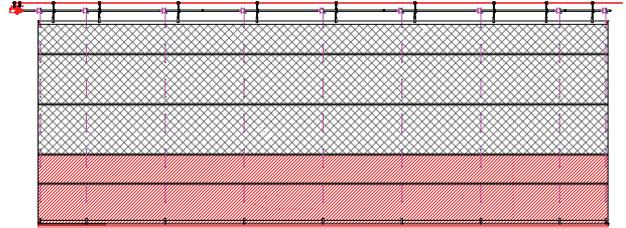
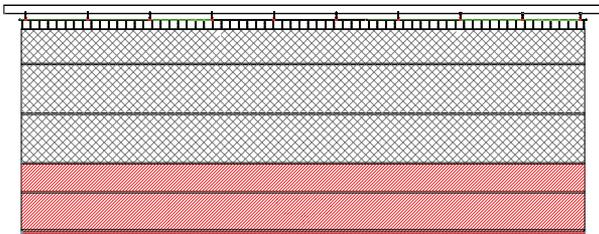

WALK-DRAW

- The most cost effective way to divide your gym
- Best curtain option for maximum clearance on ceiling heights below 28'
- A 3" pocket lines the bottom edge of the curtain to accommodate the coil-proof chain as a weighted base
- Track is made from 16 gauge galvanized steel which holds trolley wheels for easy mobility
- Vinyl fabric lines the top edge of the curtain with grommets every 12" which attach to the carriers and s-hooks
- Storage space is 1/8" per foot of the curtain
- Curtain has 1" outer edges that are doubled to eliminate fraying
- Lower section of the curtain is constructed of a solid 18 oz. vinyl and the upper section made of a 9 oz. mesh with 2" welded seams while meeting the California State Fire Code
- One- year limited warranty on materials and workmanship

FOLD UP

- Offers a clean way to divide your gymnasium into two useful areas
- Accordion folds are powered by 1/8" steel cables running through grommets vertically to a clean pocket at the bottom of the curtain with a weighted pipe
- Curtain has 1" outer edges that are doubled to eliminate fraying
- Cables wrap neatly on a 5" spool rotated by a 3/4 hp electric winch
- Lower section of the curtain is constructed of a solid 18 oz. vinyl and the upper section made of a 9 oz. mesh with 2" welded seams while meeting the California State Fire Code
- Strap connection to bottom batten tube to prevent sharp edges
- One- year limited warranty on materials and workmanship



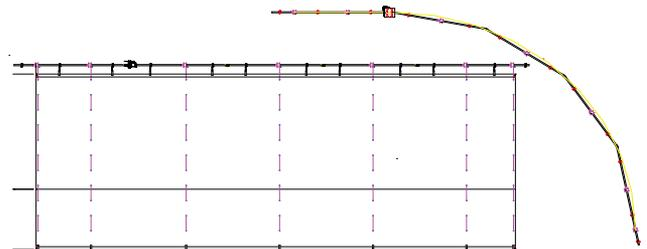
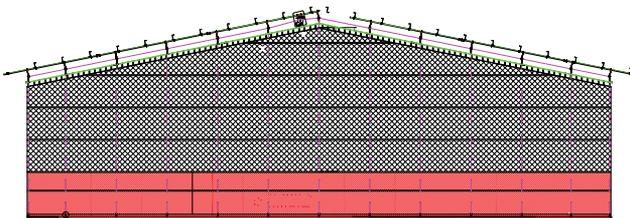

SLOPE FOLD

- These custom curtains contour to the slope of your facility's roof line for maximum ceiling coverage
- Accordion folds are powered by 1/8" steel cables spaced every 9' running through grommets vertically and pass through overhead pulleys to a 3/4 hp electric winch
- Vinyl fabric lines the top edge of the curtain with grommets every 12". S-hooks attach to these grommets on the top of the curtain by a chain and carrier rollers that sit in a 16 gauge steel channel track for maximum clearance
- Lower section of the curtain is constructed of a solid 18 oz. vinyl and the upper section made of a 9 oz. mesh with 2" welded seams while meeting the California State Fire Code
- One- year limited warranty on materials and workmanship

RADIUS FOLD

- Separates an outer running track from the playing courts inside a multi-purpose facility
- Accordion folds are powered by 1/8" steel cables spaced every 12' running through grommets which are spaced 1' 6" vertically to a clean pocket at the bottom of the curtain with a weighted pipe
- Cables are attached to an angled drive pipe that rotates on roller brackets ran by a 3/4 hp electric winch to fold up the curtain
- The curtain radius should be greater than 20'
- Curtain has 1" outer edges that are doubled to eliminate fraying
- Strap connection to bottom batten tube to prevent sharp edges
- Lower section of the curtain is constructed of a solid 18 oz. vinyl and the upper section made of a 9 oz. mesh with 2" welded seams while meeting the California State Fire Code
- One- year limited warranty on materials and workmanship

AVAILABLE VINYL COLORS

CONTACT SPALDING AT 1-800-435-3865 FOR DETAILS.



ALL COLORS ARE CAL 117 NFPA 701 ASTM E84 COMPLIANT

AVAILABLE MESH COLORS

CONTACT SPALDING AT 1-800-435-3865 FOR DETAILS.



COLOR CHOICES: Black, Gray, Red, Blue & Green

Note: Colors shown in catalog and on website may not be an exact match.



BATTING CAGE

- Designed for indoor use only
- Frame is constructed of zinc coated pipping
- Cast fittings connects perimeter with a 1 hp electric motor
- Netting attaches easily to the frame with hook and loop straps
- Black net is made of a high strength polyethylene material
- Standard mesh size is 1 3/4" with 3/4" mesh available for golf

- 417-278 Motorized Retractable 70' Cage (net not included)
- 417-279 Motorized Retractable 55' Cage (net not included)
- 417-386 12' tall x 14' wide x 70' long Batting Cage Net Package
- 417-387 12' tall x 12' wide x 70' long Batting Cage Net Package
- 417-388 12' tall x 14' wide x 55' long Batting Cage Net Package
- 417-389 12' tall x 12' wide x 55' long Batting Cage Net Package
- 417-395 12' tall x 14' wide x 70' long Golf Mesh Cage Net Package

Custom sizes, colors and nets available. Please contact Spalding at 1-800-435-3865 for additional information.



CAGE EASILY RAISES AND LOWERS FROM THE CEILING





LYNRUS AUT-O-LOC SAFETY BELT

- Designed specifically for today's moving and folding backstops
- Lightweight - only 14 lbs. / 6.43kg
- Rated for a maximum of 1,000 lbs. / 453.51kg
- Fully automatic
- Spring loaded to retract up to 35 feet. Optional 45 foot / 13.7 meter lead belt is also available
- The inertia plate activates three separate pawls to minimize the shock and instantly stop the load before it gains momentum
- Five-year manufacturers warranty applies

402-865 LynRus Aut-O-Loc Safety Belt for Backstops
401-875 Retractor Reel (not shown)



DELUXE KEY SWITCH FOR ELECTRIC WINCH

- Two-year warranty
- 402-980** Deluxe Key Switch for Electric Winch



LYNRUS REMOTE CONTROL TRANSMITTER FOR ELECTRIC WINCH

- Works in conjunction with 402-754
- 301-087** LynRus Remote Control Transmitter for Electric Winch



LYNRUS REMOTE CONTROL RECEIVER FOR ELECTRIC WINCH

- Two-year manufacturers warranty applies
 - Works in conjunction with 402-753
- 301-088** LynRus Remote Control Receiver for Electric Winch



LYNRUS QR4000 ELECTRIC WINCH

- 115 volt, single phase, instantly reversing 3/4 HP motor
- Over 1,250 lbs. of vertical line pull at 9 feet per minute
- Large grooved drum with a 4 1/2" diameter

- High speed worm gear supported for both radial and thrust loads
- Positive locking - double reduction worm gear drive provides a 200:1 reduction rate
- Sealed gear case provides a lifetime of maintenance-free operation
- Includes Deluxe Key Switch
- Five-year manufacturers warranty applies

402-742 LynRus QR4000 Electric Winch
402-489 Winch Retrofit/Refurb Kit (not shown)



LYNRUS MANUAL WINCH

- Heavy-duty 1,000 lb. capacity
- Ample, oversized flanges prevent the cable from climbing drum ends
- Efficient 40:1 worm gear ratio
- Long-lasting, ball-bearing type thrust bearing
- Maintenance-free lifetime sealed gear case
- Five-year manufacturers warranty applies

402-760 LynRus Manual Winch 1,000 lb. Capacity with Crank Handle
014-815 Replacement Handle



GYMNASIUM CONTROLLER

This control system is a major improvement over a conventional key switch used for each of your backstop winches, divider curtains, scoreboards, etc. With the Spalding® gymnasium controller, you can control up to 42 devices easily from one location with just the touch of a screen.

- Controls your gymnasium with easy-to-operate computer screens – 2 styles available
- One motor will run at a time, allowing for optimal observation of the equipment while in use
- Each relay panel can control up to 7 different motors with net working capabilities to run up to 42 devices from one location
- All low voltage displays are username and password protected to maintain equipment security
- Controller can operate: Ceiling-Suspended Backstops, Divider Curtains, Retractable Batting Cages, Height Adjusters, and Activate scoreboards, lights and sound systems
- Note: All wiring should be completed by a licensed electrician. All wiring, conduit, components and installation techniques must meet all applicable local, state and national codes
- Programmable to store various operations such as basketball practice, volleyball or basketball games, gym mode, etc. Can store up to 10 scenarios
- 10" x 10" electrical enclosure for controller is not included



401-953 ENHANCED TOUCH SCREEN



401-952 SIMPLE TOUCHSCREEN



401-950 OPERATES UP TO 7 MOTORS OR 2 AUXILIARY DEVICES



IS YOUR GYMNASIUM EQUIPMENT UP-TO-DATE?
CONTACT YOUR LOCAL CERTIFIED GYMPRO™ DEALER TO SCHEDULE AN INSPECTION.

SPALDING GYMPRO™ FACILITY ASSESSMENT

The Spalding GymPro™ Inspection program provides a floor to ceiling assessment performed by trained & experienced professionals. The inspection will evaluate and educate as to the performance of all equipment to help prioritize maintenance, repair and/or replacement decisions.

THE INSPECTION INCLUDES EVALUATION OF THE FOLLOWING EQUIPMENT:

- Basketball Rims and Backboards
- Wall Padding
- Retractable Equipment
- Volleyball Uprights and Nets
- Divider Curtains
- Accessories & More

To set up a FREE EVALUATION, find a Spalding GymPro™ Dealer nearest you on our website at spaldingequipment.com/gympro or email us at SpaldingGymPro@fotlinc.com.





OUR FOCUS WHEN MANUFACTURING SPALDING® VOLLEYBALL EQUIPMENT IS DURABILITY, PERFORMANCE AND EASE-OF-USE. OUR SPALDING® FREESTANDING VOLLEYBALL SYSTEMS INCLUDE THE FOLLOWING FEATURES:

- Designed to be used where floor plates are not available or in a tournament setting for easy set up and transport.
- Each base comes complete with 800 lbs. of steel ballast to ensure they stay in place for play.
- The units can be purchased as separate pieces or a complete system consisting of the freestanding bases, 3" steel uprights, net, antenna and padding for protection.
- The Freestanding Volleyball System can be used with specific Spalding® uprights without modification & can adapt to several, 3" volleyball upright poles.



EASILY STORE SYSTEM WHEN NOT IN USE.

- Standard 18 oz. navy blue vinyl pads are included. Other colors options are available.
- Custom lettering or logos are available at additional cost. Contact Spalding at 1-800-435-3865 for details.
- **Warranty:** poles and bases, ten-years; pads, net, winch, and antenna, one-year.

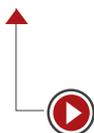

Forklifts can be used to move equipment for quick setup or easy storage.



The ref side includes a step that can be unfolded to mount the platform.



The units can be raised using a 3500 lb. jack in the front for moving into position.



RUBBER FOOT

WHETHER YOU NEED 1 OR 40 COURTS FOR TOURNAMENT OR NORMAL PLAY, USING THE SPALDING® FREESTANDING VOLLEYBALL SYSTEM COULD NOT BE EASIER.

FREESTANDING ONE-COURT VOLLEYBALL SYSTEM

System includes:

- 36" Quick Set Net Package
- Antennae Package
- Winch End Upright for Freestanding VB System
- Non-Winch End Upright for Freestanding VB System

438-165 Freestanding One-Court Volleyball System

438-150 Base & Pads Only

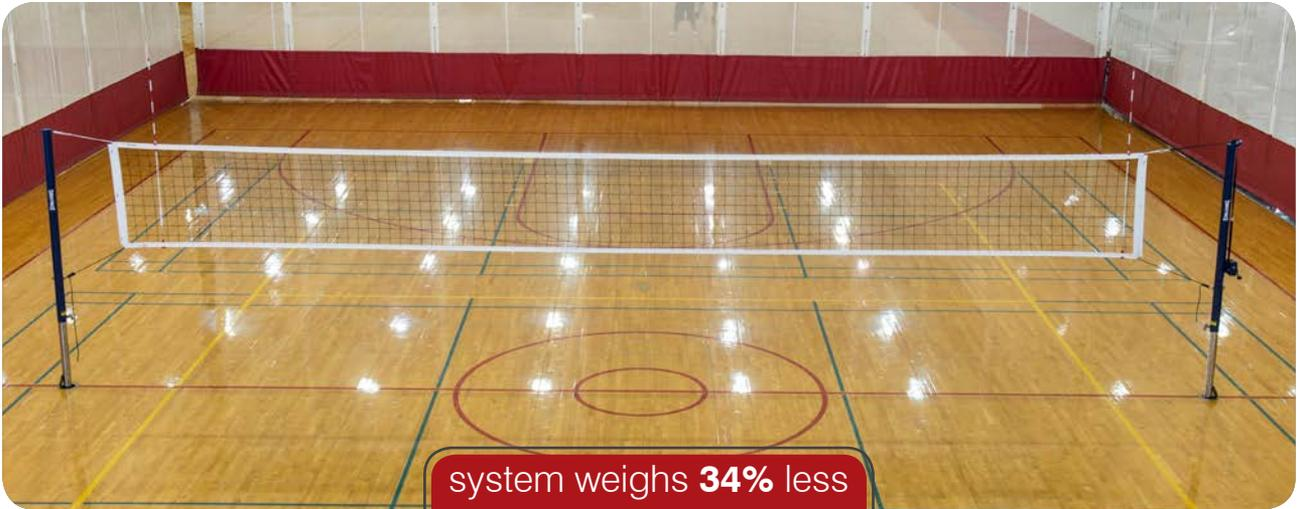

OUR FOCUS WHEN MANUFACTURING SPALDING® VOLLEYBALL EQUIPMENT IS DURABILITY, PERFORMANCE AND EASE-OF-USE. OUR SPALDING® LITE STEEL VOLLEYBALL SYSTEMS INCLUDE THE FOLLOWING FEATURES:

- The Spalding® LITE Steel System weighs 34% less on average than a standard volleyball system, with each upright weighing about 49 pounds.
- Spring-loaded outer telescoping system, adds stability while lessening deflection and bowing during play.
- Lite Steel Volleyball System uses a light weight net
- Designed to be used with the standard 3" floor sleeves as well as a Spalding® T-Base.
- Requires 3" floor sleeves - sold separately (see page 50 for details)
- Not compatible with supported referee platform
- **Warranty:** Poles and piston, ten year; parts and winch, one-year
- Meets all NCAA®, NFHS, and FIVB specifications

ONE-COURT LITE STEEL SYSTEM

Includes:

- 438-275 Spalding LITE Steel Winch End Upright (includes 408-048 Antenna Package)
- 438-276 Spalding LITE Steel Non-Winch End Upright
- 434-175 36" Light Weight Net Package
- SV210-E Upright End Pads - Pair

LWS110 Spalding® One-Court LITE Steel System

LWS210 Spalding® Two-Court LITE Steel System

*Uprights also sold as package or individual pieces. See price list for part #'s and prices.

LITE STEEL UPRIGHTS



438-275
Winch
End

438-276
Non-winch
End



NYLON STRAP
Nylon leader strap for easy net attachment



WORM GEAR WINCH
Designed to reduce backlash and keeps net tight during intense play



ROPE RATCHET
Locking mechanism permits quick tightening of bottom ropes on net



VISUAL SETTINGS
Men's, Women's, and Juniors' heights



LITE STEEL UPRIGHT WITH SV110 PAD

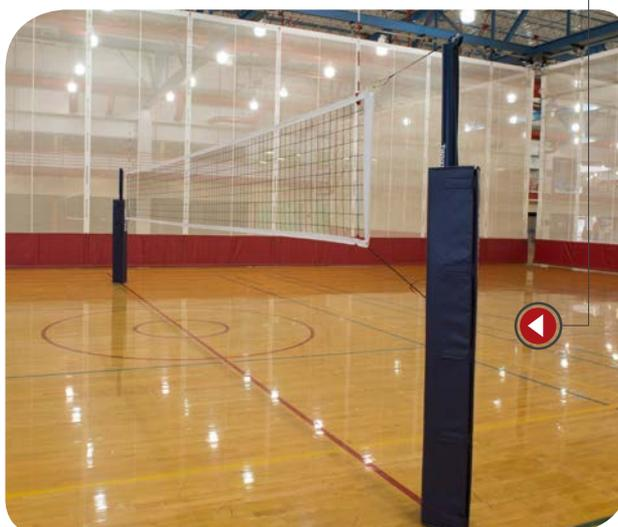



OUR FOCUS WHEN MANUFACTURING SPALDING® VOLLEYBALL EQUIPMENT IS DURABILITY, PERFORMANCE AND EASE-OF-USE. **OUR ELITE ALUMINUM SYSTEMS INCLUDE THE FOLLOWING FEATURES:**

- Lightweight and easy to set up
- High strength uprights made of 3" (76mm) O.D. extruded aluminum
- Navy blue powder coated uprights with silver powder coated pistons
- Requires 3" floor sleeves - sold separately (see page 50 for details)
- **Warranty:** poles and piston, ten-year; parts and winch, one-year
- Meets NCAA®, NFHS, and FIVB specifications

ONE-COURT ELITE ALUMINUM SYSTEM

Includes:

- 438-296 Elite Aluminum Winch End Upright (includes 408-048 Antenna Package)
- 438-297 Elite Aluminum Center Upright
- 434-214 Aramid Fiber 1M Net Package
- SV210-E Upright End Pads - Pair

SEA110 One-Court Elite Aluminum System

SEA210 Two-Court Elite Aluminum System

*Uprights also sold as package or individual pieces. See price list for part #'s and prices.

ELITE ALUMINUM UPRIGHTS



438-296 Winch End 438-297 Center 438-298 Multi-Court



HEIGHTS
Adjust to meet juniors', women's, and men's height



PULLEY GUARD
Improved pulley guard is designed to prevent cable misalignment

PISTONS
Spring-loaded, telescoping pistons for easy adjustment regardless of competitive height



ROPE RATCHET
Locking mechanism permits quick tightening of bottom ropes on net



NYLON LEADER STRAP
Nylon leader strap for easy net attachment



WORM GEAR WINCH
Adjustable height worm gear winch designed to reduce backlash and keep net tight during intense play



OUR FOCUS WHEN MANUFACTURING SPALDING® VOLLEYBALL EQUIPMENT IS DURABILITY, PERFORMANCE AND EASE-OF-USE. OUR ELITE STEEL SYSTEMS INCLUDE THE FOLLOWING FEATURES:

- High strength uprights made of 3" (76mm) O.D. steel for the highest level of competitive play
- Navy blue powder coated uprights with chrome plated pistons
- Requires 3" floor sleeves - sold separately (see page 50 for details)
- **Warranty:** poles and piston, ten-year; parts and winch, one-year
- Meets all USAV, NCAA®, NFHS, and FIVB specifications

ONE-COURT ELITE STEEL SYSTEM

Includes:

- 438-291 Elite Steel Winch End Upright (includes 408-048 Antenna Package)
- 438-292 Elite Steel Center Upright
- 434-214 Aramid Fiber 1M Net Package
- SV210-E Upright End Pads - Pair

SES110 One-Court Elite Steel System
SES210 Two-Court Elite Steel System

*Uprights also sold as package or individual pieces. See price list for part #'s and prices.

ELITE STEEL UPRIGHTS



438-291 Winch End 438-292 Center 438-293 Multi-Court



HEIGHTS
Adjust to meet juniors', women's, and men's height



NYLON LEADER STRAP
Nylon leader strap for easy net attachment



PULLEY GUARD
Improved pulley guard is designed to prevent cable misalignment

PISTONS
Spring-loaded, telescoping pistons for easy adjustment regardless of competitive height



ROPE RATCHET
Locking mechanism permits quick tightening of bottom ropes on net



WORM GEAR WINCH
Adjustable height worm gear winch designed to reduce backlash and keep net tight during intense play



SPALDING® SLIDE MULTI-SPORT SYSTEMS

include the following features:

- Lightweight and easy to set up
- High strength uprights made of 3" (76mm) O.D. extruded aluminum
- Navy blue powder coated uprights with silver powder coated sliders
- Easy infinite adjustment regardless of competitive height
- Use at all levels of volleyball, tennis, and badminton
- Requires 3" floor sleeves - sold separately (see page 50 for details)
- **Warranty:** poles and slide, five-year; parts and winch, one-year

ONE-COURT SLIDE MULTI-SPORT SYSTEM

Includes:

- 438-465 Slide Multi-Sport Upright Package (includes 408-048 Antenna Package)
- 434-203 36" Net Package
- SV210-E Upright End Pads - Pair

SS110 One-Court Slide Multi-Sport System

SS210 Two-Court Slide Multi-Sport System

*Uprights also sold as package or individual pieces. See price list for part #'s and prices.



SLIDE SYSTEM WITH SV210 PADS

SLIDE MULTI-SPORT UPRIGHTS





▲ SLIDE SYSTEM AT BADMINTON HEIGHT



MARKINGS
Visual height markings



WORM GEAR WINCH
Adjustable height worm gear winch designed to reduce backlash and keep net tight during intense play

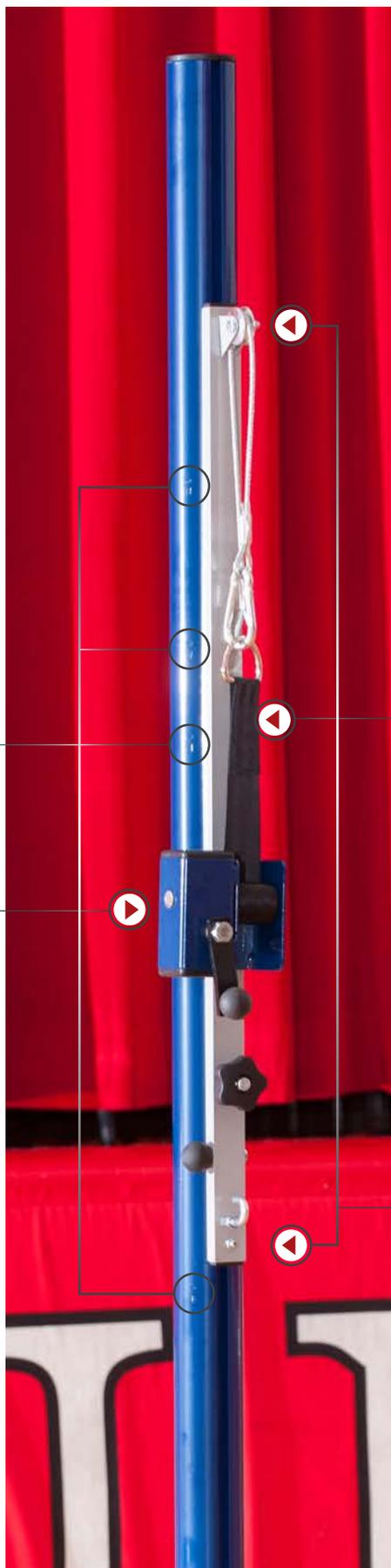

NYLON LEADER STRAP
Nylon leader strap for easy net attachment



SLIDE MECHANISM
Slide mechanism to adjust play height



TELESCOPING MULTI-SPORT UPRIGHTS include the following features:

- Uprights made of 3" (76mm) O.D. aluminum or 3" (76mm) O.D. chrome-plated steel
- Worm Gear Winch reduce backlash
- Nylon leader strap for easy net attachment
- Used for all levels of volleyball, paralympic volleyball, badminton, and tennis
- Floor plate/sleeve not included (see page 50 for floor plate/sleeve options)
- **Warranty:** poles and piston, five-year; parts and winch, one-year

TELESCOPING MULTI-SPORT ALUMINUM SYSTEMS

includes:

- 438-060 Telescoping Multi-Sport Aluminum Upright Package (includes 408-046 Antenna)
- 434-100 Telescoping Multi-Sport Quick Set Net
- Pair SV210 Upright End Pads (see page 52 for color options)

SMA110 One-Court Telescoping Multi-Sport Aluminum System

SMA210 Two-Court Telescoping Multi-Sport Aluminum System

***Add 438-061 Telescoping Multi-Sport Winch End Upright to make a two, three or four-court setup.**



ALUMINUM UPRIGHTS



TELESCOPING MULTI-SPORT NETS

- Telescoping Multi-Sport nets sold separately
- Designed for use with Telescoping Multi-Sport Systems
- 1" square mesh net

434-060 Badminton/Tennis Net

434-120 Quick Set Combo Net - 1 3/4" mesh



IS YOUR GYMNASIUM EQUIPMENT UP-TO-DATE?

CONTACT YOUR LOCAL CERTIFIED GYMPRO™ DEALER TO SCHEDULE AN INSPECTION. MORE INFORMATION ON PAGE 37.



TENNIS SYSTEM

- System includes two uprights—one with a worm gear winch and one for net tensioning
- Uprights are made of 3" (76mm) O.D. steel with a fixed height of 3' 6" (103cm)
- Floor plate/sleeve not included (see page 50 for floor plate/sleeve options)
- Net not included, sold separately

438-370 Tennis System

438-371 Winch End Upright for two-court play

434-039 Official 42' (12.8m) Tennis Net

434-040 36' (1m) Tennis Net for use on a volleyball court setup



BADMINTON SYSTEM

- System includes two uprights with adjusting height collars and badminton net
- 434-050 Badminton Net - 20' (6.1m) mesh net with 26' (7.9m) long top rope
- Uprights are made of 2" (51mm) O.D. steel tubing
- Floor sleeves sold separately
- **408-704** Locking Chrome Floor Plate/Sleeve - Pair
- **408-705** Locking Chrome Floor Plate/Sleeve - Each
- **408-721** Locking Brass Floor Plate/Sleeve - Pair
- **408-722** Locking Brass Floor Plate/Sleeve - Each

438-240 Badminton System

MULTI-COURT BADMINTON SYSTEM

- System includes one badminton upright and 434-050 Badminton Net
- Use with a 438-240 to make a two-court continuous set-up

438-241 Multi-Court Badminton System (not shown)

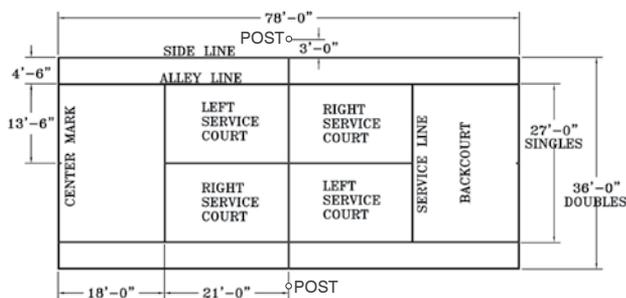

TENNIS COURT LAYOUT

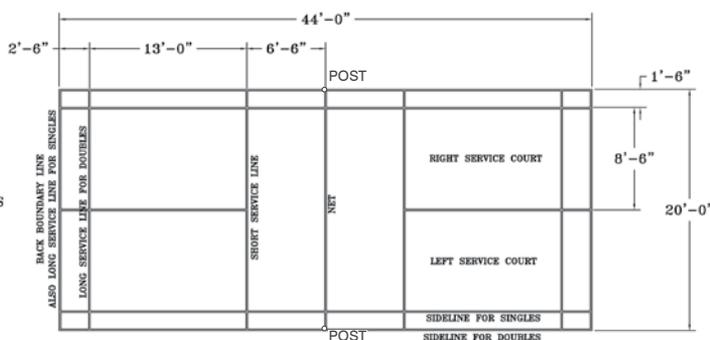

BADMINTON COURT LAYOUT



CHROME

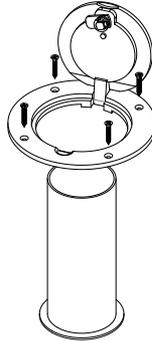

CHROME FLOOR PLATE/SLEEVE

- Chrome-plated cover plate includes slotted locking mechanism
- Opens with simple turn of a flathead screwdriver or coin
- Cover plate consists of 7" (18cm) O.D. chrome outer ring and hinged chrome cap
- Heavy-duty steel sleeve receives 3" to 3 1/2" (7.6 to 8.9cm) upright and is 8" (23cm) deep
- 1" (2.5cm) clearance required between top of floor and sleeve

- 408-785** Chrome Floor Plate/ 3" Sleeve - Pair
- 408-786** Chrome Floor Plate/ 3" Sleeve - Each
- 19885** Chrome Cover Plate assembly only
- 408-700** Locking Chrome Floor Plate/ 3" Sleeve - Pair
- 408-701** Locking Chrome Floor Plate/ 3" Sleeve - Each
- 408-702** Locking Chrome Floor Plate/ 3.5" Sleeve - Pair
- 408-703** Locking Chrome Floor Plate/ 3.5" Sleeve - Each
- 19875** Chrome Locking Cover Plate assembly only



BRASS

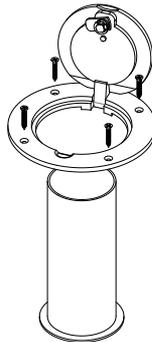

BRASS FLOOR PLATE/SLEEVE

- Brass-plated cover plate includes slotted locking mechanism
- Opens with simple turn of a flathead screwdriver or coin
- Cover plate consists of 7" (18cm) O.D. brass outer ring and hinged brass cap
- Heavy-duty steel sleeve receives 3" to 3 1/2" (7.6 to 8.9cm) upright and is 8" (23cm) deep
- 1" (2.5cm) clearance required between top of floor and sleeve

- 408-725** Locking Brass Floor Plate/ 3" Sleeve - Pair
- 408-726** Locking Brass Floor Plate/ 3" Sleeve - Each
- 408-727** Locking Brass Floor Plate/ 3.5" Sleeve - Pair
- 408-728** Locking Brass Floor Plate/ 3.5" Sleeve - Each
- 19870** Locking Brass Cover Plate assembly only



Spalding can provide adaptors for existing sleeves over 3" diameter to accommodate any Spalding® system. Call customer service at 800.435.3865 for more information.



438-318



438-319



438-121

438-123

T-BASE END BASE features:

- Designed for use in facilities where sleeve installation isn't feasible
- Recommend use with steel uprights only & requires only one floor anchor per end
- Each base has two rubber wheels for easy transporting
- Floor anchors, pads and uprights must be ordered separately

438-318 T-Base End Bases - Pair
87870 - Replacement knob

T-BASE CENTER BASE features:

- Use only with the following uprights for multiple court setups:
 - **438-290** Elite Steel Upright Package
 - **438-291** Elite Steel Winch End Upright
 - **438-293** Elite Steel Multi-Court Upright
- Requires two floor anchors per unit
- Floor anchors, pads and uprights must be ordered separately

438-319 T-Base Center Base - Each
87870 - Replacement knob

T-BASE PADS features:

- Easily attached with hook and loop fasteners
- Made with 18 oz. vinyl

438-121 T-Base End Base, Navy Pad - Pair
438-123 T-Base Center Base, Navy Pad - Each

* Other color options available — contact Spalding at **1-800-435-3865** for details.



STYLE B FLOOR ANCHOR

- Installed in securely anchored wood floors
- Replaceable spring-loaded, pop-up cap
- Includes anchoring cement

422-111 Style B Floor Anchor



STYLE BX FLOOR ANCHOR

- Same features as model 422-111, with longer knurled anchor - 3 1/4" (81mm)

422-211 Style BX Floor Anchor



STYLE C FLOOR ANCHOR

- Installed in concrete and vinyl covered concrete floors
- Replaceable spring-loaded pop-up cap
- Includes anchoring cement

422-112 Style C Floor Anchor



STYLE E FLOOR ANCHOR

- Installed in floating wood floors resting on sleepers or metal clip fasteners
- Features removable cap and anchoring cement
- Measure distance from top of floor to top of concrete to determine model

422-014 Style E Floor Anchor (less than 2 7/8")

422-029 Style E Floor Anchor (2 7/8" to 4")

422-030 Style E Floor Anchor (2 7/8" to 5")

422-031 Style E Floor Anchor (2 7/8" to 6")

422-032 Style E Floor Anchor (2 7/8" to 7")

422-034 Style E Floor Anchor (2 7/8" to 9")

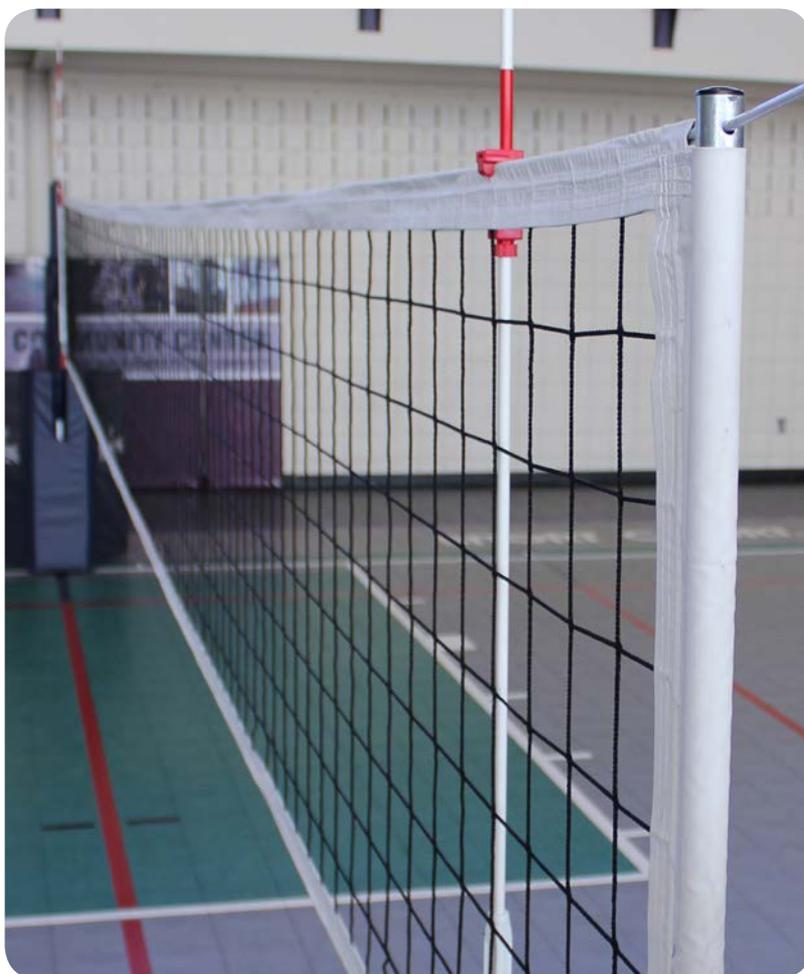

NET ORDERING INFORMATION

- Measure the distance between the center of the floor sleeves
- If the measurement is within 35' 5" to 36' 6" a custom net is NOT needed
- If the measurement is above or below 35' 5" to 36' 6", call customer service to order a custom net
- Spalding® nets are only guaranteed to fit Spalding® systems
- 1 year warranty on net packages



QUICK SET NET STYLE



ARAMID FIBER NET STYLE

36" QUICK SET NET PACKAGE

- 36" (91cm) wide net is 32' (9.75m) long, with a 33' 9" (10.3m) top pvc-coated steel cable and a 39' (11.9m) bottom polypropylene rope
- 2" (51mm) vinyl coated nylon binding on top and bottom
- Includes steel dowels, rope ratchets and net tension straps
- Use with Spalding® models 438-290, 438-295, 438-465

434-203 36" Quick Set Net Package

1M NET PACKAGE

- Net is similar to model 434-203, except it is 1m (39") wide
- Use with Spalding® models 438-290, 438-295, 438-274

434-204 1M Net Package

ARAMID FIBER 1M NET PACKAGE

- 1M (39") wide net is 32' (9.75m) long, with a 33' (10m) top cable of Aramid Fiber core rope and a 39' (11.9m) bottom polypropylene rope
- Includes steel dowels, rope ratchets and net tension straps
- Use with Spalding® models 438-290, 438-295, 438-274

434-214 Aramid Fiber 1M Net Package

MULTI-SPORT QUICK SET NET

- 36" (91cm) wide net is 32' (9.75m) long, with a 33' 6" (10.2m) top pvc-coated steel cable and a 38' (11.6m) bottom polypropylene rope
- Includes steel dowels, rope ratchets and net tension straps
- Net for use with Multi-Sport system
- Use with Spalding® models 438-060, 438-025 and 438-026

434-100 Multi-Sport Quick Set Net Custom nets available - call Spalding for additional information.

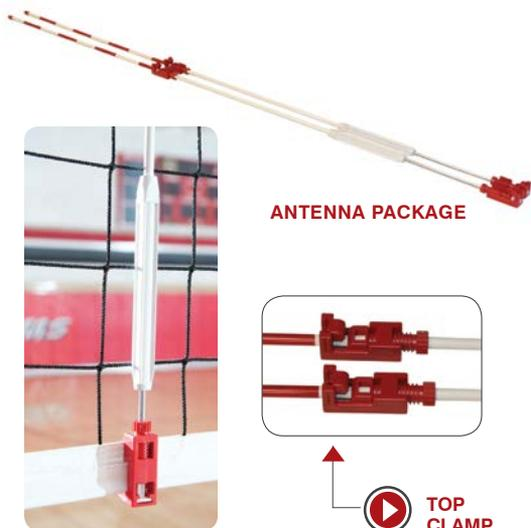

ANTENNA PACKAGE



TOP CLAMP

SPALDING® ANTENNA PACKAGE

- This package includes two red and white striped antenna assemblies
- Attachment adjustments are made easily and quickly from floor
- Improved clamping mechanism prevents loosening during play
- Adjusts to fit 36" and 1M nets
- Tested to withstand over 60 MPH serves
- Sold as pairs
- One year warranty

408-048 Antenna Package

ANTENNA/HOLDER SET

- One pair of regular fiberglass antenna and 2" (51mm) wide white vinyl holders with hook and loop fasteners

408-046 Antenna/Holder Set



ANTENNA CLAMPS

ANTENNA CLAMPS

- Set of four durable plastic clamps that fasten to the top and bottom of net
- Includes two antenna

408-167 Plastic Clamps & Antenna (Includes 4 clamps and 2 antenna)

408-168 Set of Four Plastic Clamps (clamps only)



Net Tension Straps

NET TENSION STRAPS

- Provides proper tension on net dowels, keeping net ends straight
- Set of six 1" (25mm) wide straps with hook and loop fasteners and high impact retainer ring

434-030 Net Tension Straps



NET CHAIN

NET HEIGHT CHAIN

- Net Height Chain hooks to top of net
- Red indicators on chain show proper net height for men, women, co-ed and various age groups

408-031 Net Height Chain



ROPE COVERS



ROPE COVERS

- Set of four vinyl volleyball rope covers that attach to the upper and lower ropes or cables of net
- Available in black only

438-072 Rope Covers



ROPE RATCHET PACKAGE

- Locking mechanism permits quick tightening of bottom ropes on net
- Package includes two rope ratchets

434-020 Rope Ratchet Package



SV110-E END PAD

SV110-C CENTER PAD

SV110 UPRIGHT END PADS

- Made in one piece for end pads
- Can select a pair of single wrap end pads or a 2-piece center
- Pads are 70" high and 1" thick
- Made of 18 oz. vinyl
- Fifteen colors available

SV110-E End Pads
SV110-C Center Pads



SV210 STYLE

SV210 UPRIGHT CENTER & END PADS

- Made in four-sided (two-piece) end pads and center pads
- Can be ordered as each or pair
- Pads are 6' high and 1" thick
- Made of 18 oz. vinyl
- Fifteen colors available

SV210-E End Pads
SV210-C Center Pads



SV210 GRAPHIC PAD

DIGITAL GRAPHIC UPRIGHT PADS

- All digital graphics are done using state-of-the-art, six-color large format printers
- Pads are 6' high and 1" thick
- Made of 14 oz. vinyl
- Durable, vivid inks ensure that your padding will outlast the silk-screens and vinyl applications of the past
- Our lamination process decreases the likelihood of scratching as well as regular wear-and-tear from daily use
- Available in the SV210 style only
- 1 year warranty against manf. defects

438-075 Digital Upright Pads - Pair
438-076 Digital Upright Pads - Each

SV110 UPRIGHT PAD SPECIFICATIONS:

END UPRIGHTS: 1 PACKAGE - 16 LB. (7 KG), 17" X 18" X 35" (432 MM X 686 MM X 889 MM), 6.19 CF

CENTER UPRIGHT: 1 PACKAGE - 10 LB. (4.5 KG), 17" X 18" X 35" (432 MM X 686 MM X 889 MM), 6.19 CF

SV210 UPRIGHT PAD SPECIFICATIONS:

END UPRIGHTS: 1 PACKAGE - 14 LB. (6 KG), 10" X 68" X 10" (254 MM X 1727 MM X 254 MM), 3.9 CF

CENTER UPRIGHT: 1 PACKAGE - 9 LB. (4 KG), 10" X 68" X 10" (254 MM X 1727 MM X 254 MM), 3.9 CF

DIGITAL GRAPHIC PADS SPECIFICATIONS:

END UPRIGHTS: 1 PACKAGE - 14 LB. (6 KG), 10" X 68" X 10" (254 MM X 1727 MM X 254 MM), 3.9 CF

CENTER UPRIGHT: 1 PACKAGE - 9 LB. (4 KG), 10" X 68" X 10" (254 MM X 1727 MM X 254 MM), 3.9 CF

18 oz. AVAILABLE PADDING COLORS - CONTACT SPALDING AT 1-800-435-3865 FOR DETAILS.



Note: Colors shown in catalog and on website may not be an exact match.

ADJUSTABLE HEIGHT REFEREE PLATFORM

- Meets the USAV 2.6 d Rule: “The platform must be on a support and adjustable in height.”
- Four point emphasis: adjustable, collapsible, movable, and comfortable
- Platform has THREE levels of adjustment at each men’s and women’s heights (six total heights)
- Slip resistant material on steps to improve footing
- Comfort padding on platform for extended periods of standing
- Includes wheels for easy transport on and off the court.
- Unit folds for easy and convenient storage

438-216 Adjustable Height Referee Platform
FS310 Adjustable Referee Platform Pads - Six Piece Set



Multiple Adjustment Areas

3 Levels of adjustment

FREESTANDING REFEREE PLATFORM

- Meets NFHS Specifications
- Portable unit can be used with any volleyball system
- Base has wheels for easy transporting
- Unit folds for storage
- Platform height is 44” (112cm) high, 29” (74cm) wide
- Unit has protective rubber-tipped legs
- Pads not included

438-116 Freestanding Referee Platform



Folds for Convenient Storage

FREESTANDING REFEREE PLATFORM PADS

- Meets NFHS Specifications
- Padding comes in six-piece or one-piece configurations
- Custom colors and custom digital graphic pads available - Contact Spalding at 1-800-435-3865 for details

FS110 Freestanding Referee Platform Pads
 Navy Blue, Six-Piece Set

FS210 Freestanding Referee Platform Pad
 One-Piece Pad

438-065 Digital Referee Platform Pads - available in six-piece configuration only

* see padding colors on opposite page



FS110

438-065

FS210



VOLLEYBALL EQUIPMENT CART

- Holds and transports up to four uprights, padding, nets and one referee platform
- Four swivel casters permit travel through a 36" (91cm) doorway

438-127 Volleyball Equipment Cart



VOLLEYBALL EQUIPMENT CARRIER

- Holds and transports up to six uprights, one referee platform, all padding and nets
- Four swivel casters permit travel through a 36" (91cm) doorway

438-057 Volleyball Equipment Carrier



VOLLEYBALL UPRIGHT TRANSPORTER

- Fits on all 3" uprights for easy transport
- Sold individually

438-145 Volleyball Upright Transporter



UPRIGHT STORAGE RACK

- Holds all styles of Spalding® uprights
- Attaches to wall to hold uprights in a vertical position
- Lockable for security purposes (padlock not included)
- Removable locking pin allows for easy access to individual uprights

438-413 Upright Storage Rack

— Holds 3 Uprights

438-414 Upright Storage Rack

— Holds 4 Uprights

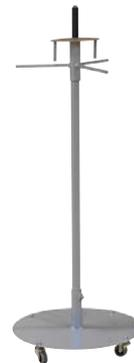

Shown with net

VOLLEYBALL NET STORAGE RACK

- Neatly holds and transports one volleyball net of any size
- Four swivel casters allow for easy maneuverability
- Non-marking casters

408-055 Volleyball Net Storage Rack



*Net Winder & equipment sold separately



438-132



438-130



438-133

NET WINDER

The net winder is designed to be used horizontally to wind up a net on the Net Winder Cart or with the Net Winder Wall Mount.

- Designed for 36" and one meter nets
- Can be used on most volleyball carts with an outside distance of no more than 49.5"
- Powder-coated for durability and long life.
- Includes straps to secure the net to the net winder when winding

438-132 Net Winder

438-130 Net Winder Cart

438-133 Net Winder Wall Mount



VOLLEYBALL SCOREBOARD

- Lightweight frame sits on any flat surface
- Numerals are 5" tall in red and green lettering
- Unit is 20" wide x 12" high x 7" deep

408-030 Volleyball Scoreboard

COACHES' choice!



VOLLEYBALL TRUCK

- Base is made of aluminum 1" x 1" anodized square tubing
- Dimensions: 25" L x 25" W x 18 1/2" deep
- Includes nylon carry bag with shoulder strap (not shown)
- Holds approximately 20 volleyballs
- Navy blue nylon material

438-056 Volleyball Truck



SPALDING® VOLLEYCADDY

- Innovative cart and carry system
- On-court ball cart reconfigures for easy transportation
- Kit includes nylon bag with carry strap
- Holds up to 8 volleyballs
- Navy blue color only

438-055 Spalding® VolleyCaddy



WORM GEAR WINCH

WORM GEAR WINCH WITH SLIDE COLLAR

- Adjustable height worm gear winch is designed to reduce backlash and keeps net tight during intense play
- Nylon leader strap allows for easy net attachment
- For use on Elite Aluminum & Elite Steel Systems
- Fits on 3" (76mm) O.D. uprights
- One-year warranty

438-383 Worm Gear Winch with Slide Collar

438-380 Worm Gear Winch (not shown)



VOLLEYBALL SINGLE COURT LAYOUT

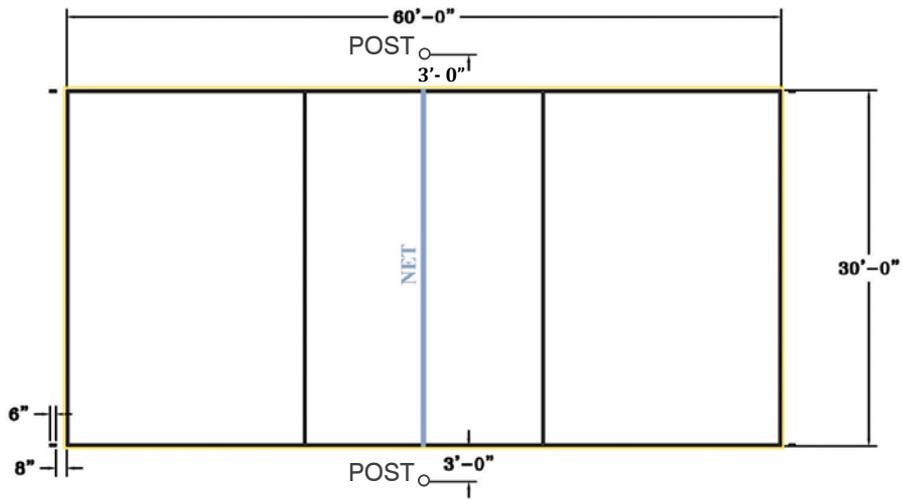

VOLLEYBALL MULTI COURT FIVE HOLE LAYOUT

VOLLEYBALL MULTI COURT SIX HOLE LAYOUT

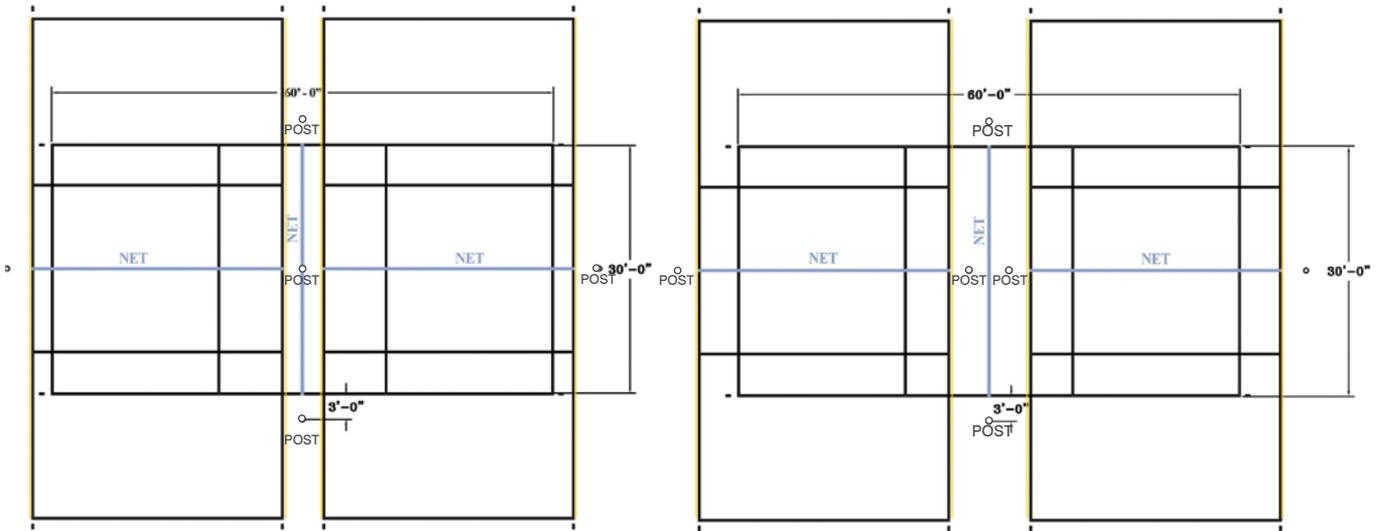

*Measurements are all figured to the outside of the line.



**IS YOUR GYMNASIUM
EQUIPMENT UP-TO-DATE?**

**CONTACT YOUR LOCAL CERTIFIED GYMPRO™
DEALER TO SCHEDULE AN INSPECTION.
MORE INFORMATION ON PAGE 37.**



connect with

SPALDING
TRUE TO THE GAME®



www.spaldingequipment.com



Be our Friend at facebook.com/spaldingequipment



Tweet Us at twitter.com/SpaldingEquip



Follow linkedin.com/company/spalding-equipment



Hang Out at google.com/+Spaldingequipment



Watch at youtube.com/SpaldingEquipment



Get our FREE Newsletter

Product specials, videos, company news, and more delivered to your inbox!
Scan this code or visit spaldingequipment.com/connect to sign up!



SPALDING
TRUE TO THE GAME®

CATALOG AVAILABLE DIGITALLY



Spalding Catalogs



Or download the catalog as a pdf at
spaldingequipment.com/catalog



A series of horizontal lines for writing notes, spanning the width of the page.

200 American Ave.
Jefferson, IA 50129
1-800-435-3865
spaldingequipment.com

NBA®

The NBA® and individual NBA® member team identifications are the intellectual property of NBA® Properties, Inc. and the respective NBA® member teams. (c) 2015 NBA® Properties, Inc. All rights reserved.

WNBA

The WNBA and WNBA team identifications are trademarks and copyrighted designs, and/or other forms of intellectual property of WNBA Enterprises, LLC and may not be used, in whole or in part, without the prior written consent of WNBA Enterprises, LLC. © 2015 WNBA Enterprises, LLC. All rights reserved.

D-League

The Spalding® trademark is owned by Russell Brands, LLC or its affiliate. © 2015 Russell Brands, LLC. All rights reserved.

The NBA DL and NBA DL team identifications are the trademarks and copyrighted designs, and/or other forms of intellectual property of NBA Development League, LLC. and may not be used, in whole or in part, without the prior written consent of NBA Development League, LLC, © 2015 NBA Development League, LLC. All Rights Reserved.

NCAA® and FINAL FOUR™

The NCAA® and FINAL FOUR™ are registered trademarks of The National Collegiate Athletic Association.

GENERAL WARRANTY INFORMATION

Russell Brands, LLC (owner of the Spalding® trademark) ("Spalding") warrants its products against defects in material and workmanship. Without charge, Spalding® will, at its option, either repair or replace any products shown to our satisfaction to be defective within the designated warranty timeframe, provided it is returned to the factory (after authorization), transportation prepaid. This warranty covers only products manufactured by Spalding® and does not extend to transportation, installation or replacement charges incurred by customer; nor does it apply to products or components of another manufacturer used in conjunction with Spalding® products according to the terms hereof and standards acceptable in Spalding®'s industry. This warranty is exclusive and in lieu of any other express or implied warranties, including, but not limited to, any implied warranty of merchantability or fitness for particular purpose. Modification of Spalding® products renders the warranty void and could create a risk of severe personal injury. Abuse, misuse, abnormal usage, faulty installation, vandalism, acts of nature, improper maintenance or unauthorized repairs are not covered under warranty. No obligations or liabilities exist on the part of Spalding® for consequential damages arising out of or in connection with the use or performance of the products.

©2015 Russell Brands, LLC